

# Super Fast Recovery Diode

preliminary data

$$I_{FAVM} = 63 \text{ A}$$

$$V_{RRM} = 1600 \text{ V}$$

$$t_{rr} = 40 \text{ ns}$$

**Part number**  
DSDI60-16A

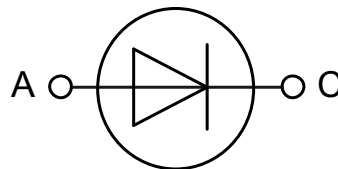
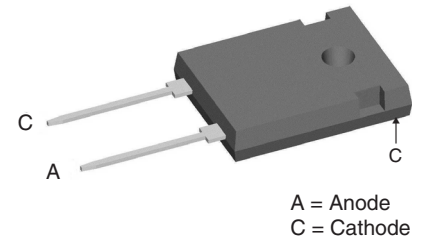

### Features / Advantages:

- Planar passivated chips
- Very short recovery time
- Extremely low switching losses
- Low  $I_{RM}$  values
- Soft recovery behaviour
- High reliability circuit operation
- Low voltage peaks for reduced protection circuits
- Low noise switching
- Low losses
- Operating at lower temperature or space saving by reduced cooling

### Applications:

- Antiparallel diode for high frequency switching devices
- Anti saturation diode
- Snubber diode
- Free wheeling diode in converters and motor control circuits
- Rectifiers in switch mode power supplies (SMPS)
- Inductive heating and melting
- Uninterruptible power supplies (UPS)
- Ultrasonic cleaners and welders

### Package: TO-247 AD

- International standard package JEDEC TO-247 AD
- Creepage distance between leads 8.5 mm
- Epoxy meets UL 94V-0

### Disclaimer Notice

Information furnished is believed to be accurate and reliable. However, users should independently evaluate the suitability of and test each product selected for their own applications. Littelfuse products are not designed for, and may not be used in, all applications. Read complete Disclaimer Notice at [www.littelfuse.com/disclaimer-electronics](http://www.littelfuse.com/disclaimer-electronics).



preliminary data

Diode				Ratings			
Symbol	Definitions	Conditions	min.	typ.	max.		
$V_{RRM}$	max. repetitive reverse voltage				1600	V	
$V_{RSM}$	max. non-repetitive reverse voltage				1600	V	
$I_{FRMS}$	RMS forward current		$T_{VJ} = 150^{\circ}\text{C}$		100	A	
$I_{FAVM}$ ①	max. average forward current	rectangular, d = 0.5	$T_C = 60^{\circ}\text{C}$		63	A	
$I_{FRM}$	max. repetitive forward current	$t_p < 10 \mu\text{s}$ rep. rating, pulse width limited by $T_{VJM}$			800	A	
$I_{FSM}$	max. surge forward current	t = 10 ms (50 Hz), sine	$T_{VJ} = 45^{\circ}\text{C}$		500	A	
		t = 8.3 ms (60 Hz), sine			540	A	
		t = 10 ms (50 Hz), sine	$T_{VJ} = 150^{\circ}\text{C}$		450	A	
		t = 8.3 ms (60 Hz), sine			480	A	
$I^2t$	$I^2t$ value for fusing	t = 10 ms (50 Hz), sine	$T_{VJ} = 45^{\circ}\text{C}$		1250	A <sup>2</sup> s	
		t = 8.3 ms (60 Hz), sine			1200	A <sup>2</sup> s	
		t = 10 ms (50 Hz), sine	$T_{VJ} = 150^{\circ}\text{C}$		1000	A <sup>2</sup> s	
		t = 8.3 ms (60 Hz), sine			950	A <sup>2</sup> s	
$I_R$	reverse current	$V_R = V_{RRM}$	$T_{VJ} = 25^{\circ}\text{C}$	1	2	mA	
		$V_R = 0.8 \cdot V_{RRM}$	$T_{VJ} = 25^{\circ}\text{C}$	0.5		mA	
		$V_R = 0.8 \cdot V_{RRM}$	$T_{VJ} = 125^{\circ}\text{C}$	3		mA	
$V_F$	forward voltage	$I_F = 70 \text{ A}$	$T_{VJ} = 125^{\circ}\text{C}$	2.6		V	
			$T_{VJ} = 25^{\circ}\text{C}$		4.1	V	
$V_{TO}$	threshold voltage		$T_{VJ} = 150^{\circ}\text{C}$		1.9	V	
$r_T$	slope resistance	for power-loss calculations only	$T_{VJ} = 150^{\circ}\text{C}$		10	mΩ	
$P_{tot}$	total power dissipation		$T_{VJ} = 25^{\circ}\text{C}$		416	W	
$R_{thJC}$	thermal resistance junction to case				0.4	K/W	
$R_{thCH}$	thermal resistance junction to heatsink			0.25		K/W	
$t_{rr}$	reverse recovery time	$I_F = 1 \text{ A}; -di/dt = 200 \text{ A}/\mu\text{s}; V_R = 30 \text{ V}$	$T_{VJ} = 25^{\circ}\text{C}$		40	ns	
$t_{rr}$	reverse recovery time	$I_F = 70 \text{ A}; -di_F/dt = 500 \text{ A}/\mu\text{s}$	$T_{VJ} = 25^{\circ}\text{C}$		300	ns	
$I_{RM}$	max. reverse recovery current	$V_R = 1000 \text{ V}$			60	A	
$t_{rr}$	reverse recovery time	$I_F = 70 \text{ A}; -di_F/dt = 500 \text{ A}/\mu\text{s}$	$T_{VJ} = 125^{\circ}\text{C}$		400	ns	
$I_{RM}$	max. reverse recovery current	$V_R = 1000 \text{ V}$			85	A	

①  $I_{FAVM}$  rating includes reverse blocking losses at  $T_{VJM}$ ,  $V_R = 0.8 V_{RRM}$ , duty cycle d = 0.5

preliminary data

Package TO-247 AD			Ratings			
Symbol	Definitions	Conditions	min.	typ.	max.	
$I_{RMS}$	RMS current				70	A
$T_{VJ}$	virtual junction temperature		-40		150	°C
$T_{op}$	operation temperature		-40		125	°C
$T_{stg}$	storage temperature		-40		150	°C
<b>Weight</b>				6		g
$M_D$	mounting torque		0.8		1.2	Nm
$F_c$	mounting force with clip		20		120	N

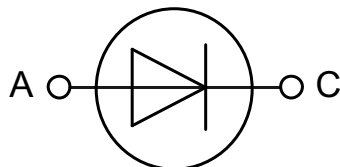
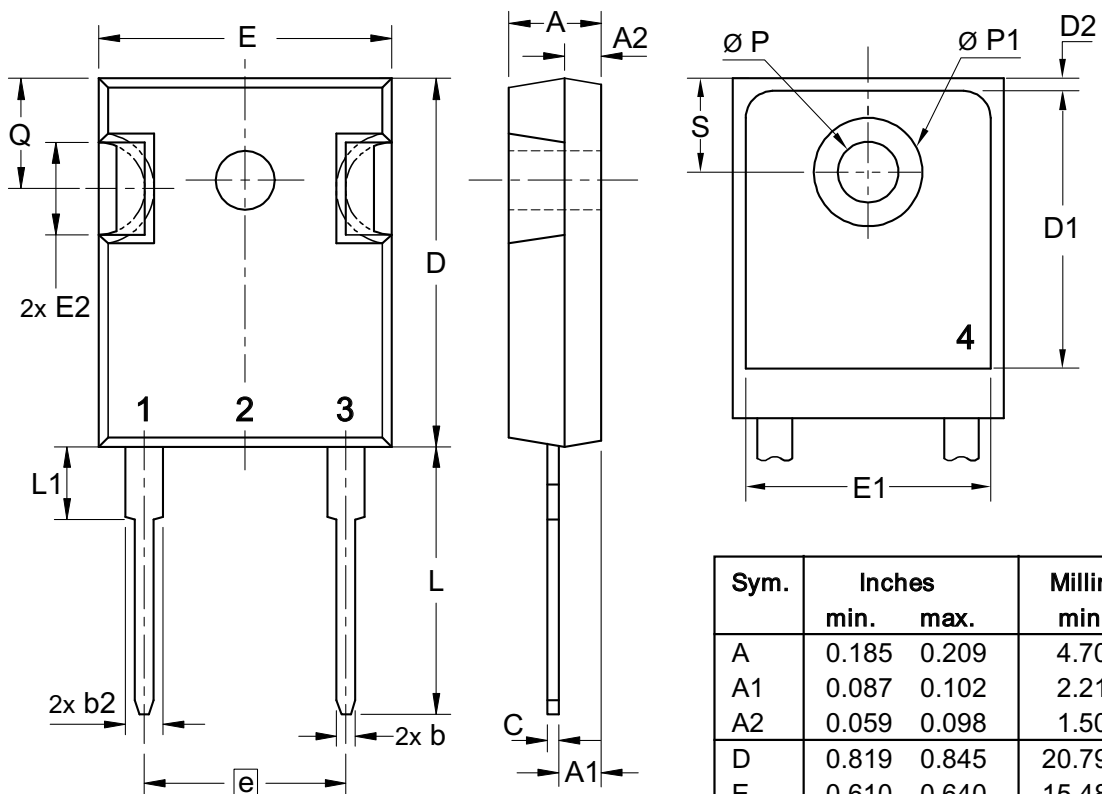

Sym.	Inches		Millimeter	
	min.	max.	min.	max.
A	0.185	0.209	4.70	5.30
A1	0.087	0.102	2.21	2.59
A2	0.059	0.098	1.50	2.49
D	0.819	0.845	20.79	21.45
E	0.610	0.640	15.48	16.24
E2	0.170	0.216	4.31	5.48
e	0.430 BSC		10.92 BSC	
L	0.780	0.800	19.80	20.30
L1	-	0.177	-	4.49
Ø P	0.140	0.144	3.55	3.65
Q	0.212	0.244	5.38	6.19
S	0.242 BSC		6.14 BSC	
b	0.039	0.055	0.99	1.40
b2	0.065	0.094	1.65	2.39
b4	0.102	0.135	2.59	3.43
c	0.015	0.035	0.38	0.89
D1	0.515	-	13.07	-
D2	0.020	0.053	0.51	1.35
E1	0.530	-	13.45	-
Ø P1	-	0.29	-	7.39