



Standard Rectifier

$$V_{RRM} = 2 \times 1200 \text{ V}$$

$$I_{FAV} = 30 \text{ A}$$

$$V_F = 1.2 \text{ V}$$

Phase leg

Part number

DMA30P1200HB

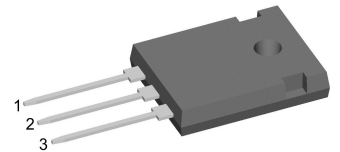

Backside: anode/cathode

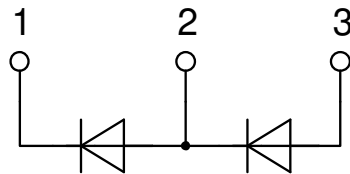

Features / Advantages:

- Planar passivated chips
- Very low leakage current
- Very low forward voltage drop
- Improved thermal behaviour
- High commutation robustness
- High surge capability

Applications:

- Diode for main rectification
- For single and three phase bridge configurations

Package: TO-247

- Industry standard outline
- RoHS compliant
- Epoxy meets UL 94V-0

Disclaimer Notice

Information furnished is believed to be accurate and reliable. However, users should independently evaluate the suitability of and test each product selected for their own applications. Littelfuse products are not designed for, and may not be used in, all applications. Read complete Disclaimer Notice at www.littelfuse.com/disclaimer-electronics.



| Rectifier | | | | Ratings | | | |
|------------|--|---|------------------------------|---------|------|---------------|------------------|
| Symbol | Definition | Conditions | min. | typ. | max. | Unit | |
| V_{RSM} | max. non-repetitive reverse blocking voltage | | | | 1300 | V | |
| V_{RRM} | max. repetitive reverse blocking voltage | | | | 1200 | V | |
| I_R | reverse current | $V_R = 1200\text{ V}$ | | | 40 | μA | |
| | | $V_R = 1200\text{ V}$ | | | 1.5 | mA | |
| V_F | forward voltage drop | $I_F = 30\text{ A}$ | | | 1.26 | V | |
| | | $I_F = 60\text{ A}$ | | | 1.53 | V | |
| | | $I_F = 30\text{ A}$ | $T_{VJ} = 150^\circ\text{C}$ | | | 1.20 | V |
| | | $I_F = 60\text{ A}$ | $T_{VJ} = 150^\circ\text{C}$ | | | 1.57 | V |
| I_{FAV} | average forward current | $T_C = 130^\circ\text{C}$ 180° sine | | | 30 | A | |
| V_{F0} | threshold voltage | } for power loss calculation only | | | 0.81 | V | |
| r_F | slope resistance | | | | 12.7 | m Ω | |
| R_{thJC} | thermal resistance junction to case | | | | 0.8 | K/W | |
| R_{thCH} | thermal resistance case to heatsink | | | 0.3 | | K/W | |
| P_{tot} | total power dissipation | | | | 185 | W | |
| I_{FSM} | max. forward surge current | $t = 10\text{ ms}; (50\text{ Hz}), \text{ sine}$ | $T_{VJ} = 45^\circ\text{C}$ | | | 370 | A |
| | | $t = 8,3\text{ ms}; (60\text{ Hz}), \text{ sine}$ | $V_R = 0\text{ V}$ | | | 400 | A |
| | | $t = 10\text{ ms}; (50\text{ Hz}), \text{ sine}$ | $T_{VJ} = 150^\circ\text{C}$ | | | 315 | A |
| | | $t = 8,3\text{ ms}; (60\text{ Hz}), \text{ sine}$ | $V_R = 0\text{ V}$ | | | 340 | A |
| I^2t | value for fusing | $t = 10\text{ ms}; (50\text{ Hz}), \text{ sine}$ | $T_{VJ} = 45^\circ\text{C}$ | | | 685 | A ² s |
| | | $t = 8,3\text{ ms}; (60\text{ Hz}), \text{ sine}$ | $V_R = 0\text{ V}$ | | | 665 | A ² s |
| | | $t = 10\text{ ms}; (50\text{ Hz}), \text{ sine}$ | $T_{VJ} = 150^\circ\text{C}$ | | | 495 | A ² s |
| | | $t = 8,3\text{ ms}; (60\text{ Hz}), \text{ sine}$ | $V_R = 0\text{ V}$ | | | 480 | A ² s |
| C_J | junction capacitance | $V_R = 400\text{ V}; f = 1\text{ MHz}$ | $T_{VJ} = 25^\circ\text{C}$ | | 11 | pF | |



| Package TO-247 | | | Ratings | | | |
|----------------|------------------------------|--------------|---------|------|------|------|
| Symbol | Definition | Conditions | min. | typ. | max. | Unit |
| I_{RMS} | RMS current | per terminal | | | 70 | A |
| T_{VJ} | virtual junction temperature | | -55 | | 175 | °C |
| T_{op} | operation temperature | | -55 | | 150 | °C |
| T_{stg} | storage temperature | | -55 | | 150 | °C |
| Weight | | | | 6 | | g |
| M_D | mounting torque | | 0.8 | | 1.2 | Nm |
| F_C | mounting force with clip | | 20 | | 120 | N |

Product Marking

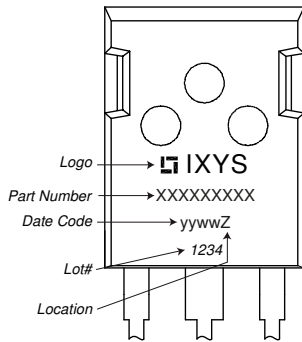

Part description

- D = Diode
- M = Standard Rectifier
- A = (up to 1800V)
- 30 = Current Rating [A]
- P = Phase leg
- 1200 = Reverse Voltage [V]
- HB = TO-247AD (3)

| Ordering | Ordering Number | Marking on Product | Delivery Mode | Quantity | Code No. |
|----------|-----------------|--------------------|---------------|----------|----------|
| Standard | DMA30P1200HB | DMA30P1200HB | Tube | 30 | 522386 |

| Similar Part | Package | Voltage class |
|--------------|--------------|---------------|
| DMA30P1600HB | TO-247AD (3) | 1600 |

Equivalent Circuits for Simulation

* on die level

$T_{VJ} = 175^{\circ}C$

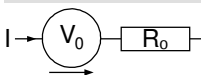

Rectifier

| | | | |
|--------------|--------------------|------|----|
| $V_{0 \max}$ | threshold voltage | 0.81 | V |
| $R_{0 \max}$ | slope resistance * | 10.1 | mΩ |



Outlines TO-247

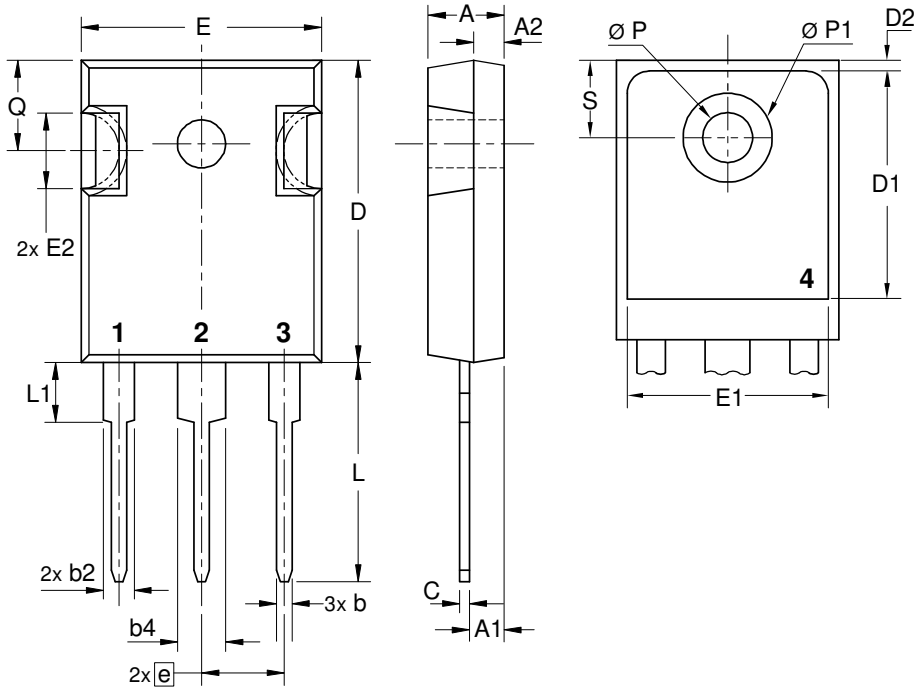

| Sym. | Inches | | Millimeter | |
|------|-----------|-------|------------|-------|
| | min. | max. | min. | max. |
| A | 0.185 | 0.209 | 4.70 | 5.30 |
| A1 | 0.087 | 0.102 | 2.21 | 2.59 |
| A2 | 0.059 | 0.098 | 1.50 | 2.49 |
| D | 0.819 | 0.845 | 20.79 | 21.45 |
| E | 0.610 | 0.640 | 15.48 | 16.24 |
| E2 | 0.170 | 0.216 | 4.31 | 5.48 |
| e | 0.215 BSC | | 5.46 BSC | |
| L | 0.780 | 0.800 | 19.80 | 20.30 |
| L1 | - | 0.177 | - | 4.49 |
| Ø P | 0.140 | 0.144 | 3.55 | 3.65 |
| Q | 0.212 | 0.244 | 5.38 | 6.19 |
| S | 0.242 BSC | | 6.14 BSC | |
| b | 0.039 | 0.055 | 0.99 | 1.40 |
| b2 | 0.065 | 0.094 | 1.65 | 2.39 |
| b4 | 0.102 | 0.135 | 2.59 | 3.43 |
| c | 0.015 | 0.035 | 0.38 | 0.89 |
| D1 | 0.515 | - | 13.07 | - |
| D2 | 0.020 | 0.053 | 0.51 | 1.35 |
| E1 | 0.530 | - | 13.45 | - |
| Ø P1 | - | 0.29 | - | 7.39 |

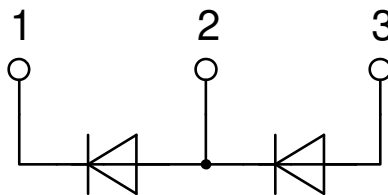

Rectifier

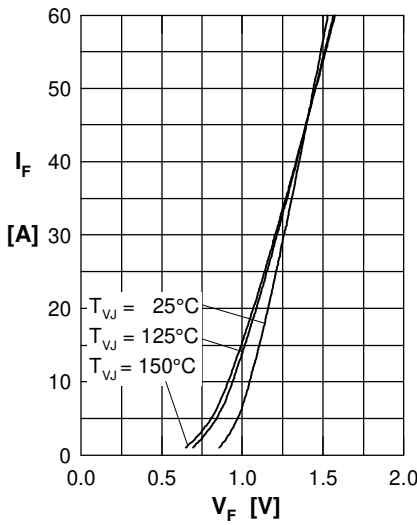

Fig. 1 Forward current versus voltage drop per diode

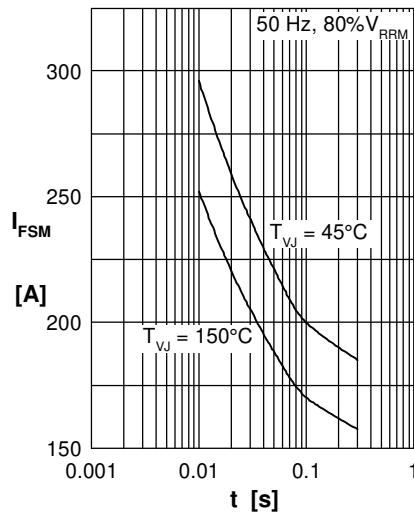

Fig. 2 Surge overload current versus time per diode

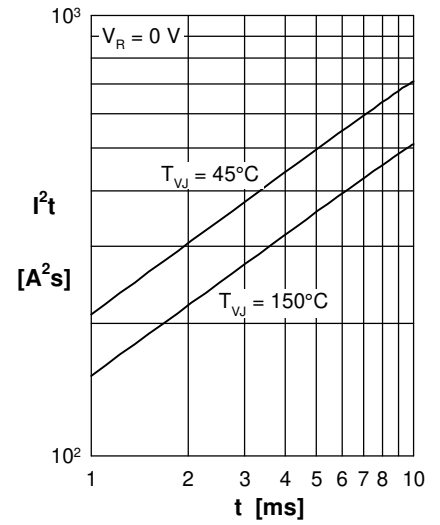

Fig. 3 I^2t versus time per diode

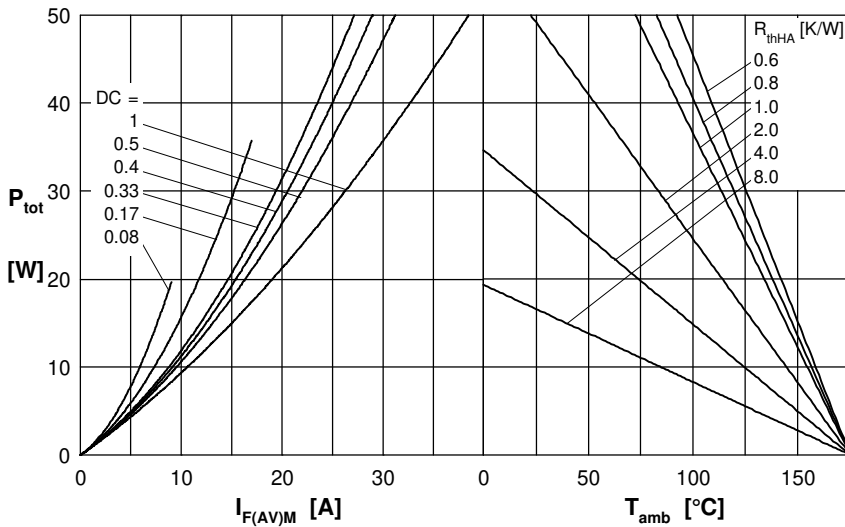

Fig. 4 Power dissipation versus direct output current and ambient temperature per diode

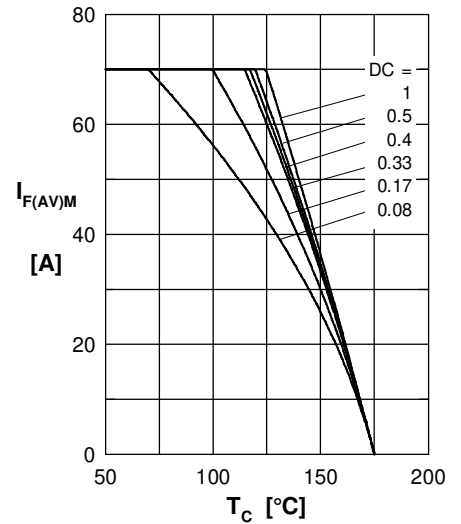

Fig. 5 Max. forward current versus case temperature per diode

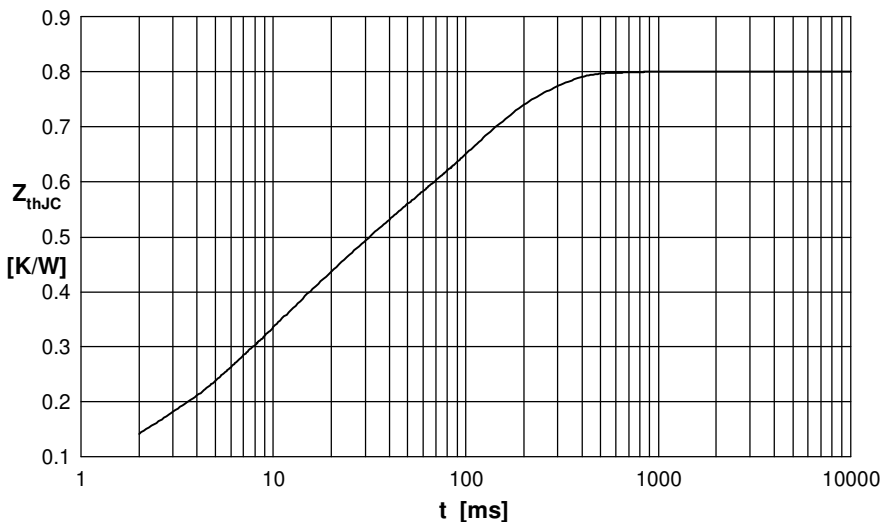

Fig. 6 Transient thermal impedance junction to case versus time per diode

Constants for Z_{thJC} calculation:

| i | R_{thi} (K/W) | t_i (s) |
|---|-----------------|-----------|
| 1 | 0.05 | 0.0006 |
| 2 | 0.13 | 0.0040 |
| 3 | 0.25 | 0.0130 |
| 4 | 0.37 | 0.1100 |