

# Standard Rectifier

$$V_{RRM} = 1600 \text{ V}$$

$$I_{FAV} = 10 \text{ A}$$

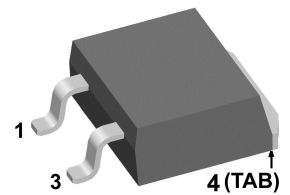
$$V_F = 1.21 \text{ V}$$

## Single Diode

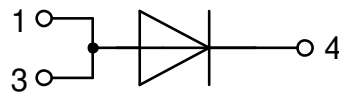
### Part number

**DMA10IM1600PZ**

Marking on Product: DMA10IM1600PZ



Backside: cathode



### Features / Advantages:

- Planar passivated chips
- Very low leakage current
- Very low forward voltage drop
- Improved thermal behaviour

### Applications:

- Diode for main rectification
- For single and three phase bridge configurations

### Package: TO-263 (D2Pak-HV)

- Industry standard outline
- RoHS compliant
- Epoxy meets UL 94V-0
- High creepage distance between terminals

### Disclaimer Notice

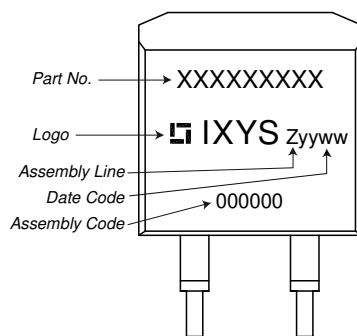
Information furnished is believed to be accurate and reliable. However, users should independently evaluate the suitability of and test each product selected for their own applications. Littelfuse products are not designed for, and may not be used in, all applications. Read complete Disclaimer Notice at [www.littelfuse.com/disclaimer-electronics](http://www.littelfuse.com/disclaimer-electronics).

Rectifier				Ratings			
Symbol	Definition	Conditions		min.	typ.	max.	Unit
$V_{RSM}$	max. non-repetitive reverse blocking voltage					1700	V
$V_{RRM}$	max. repetitive reverse blocking voltage					1600	V
$I_R$	reverse current	$V_R = 1600$ V	$T_{VJ} = 25^\circ\text{C}$			10	$\mu\text{A}$
		$V_R = 1600$ V	$T_{VJ} = 150^\circ\text{C}$			0.2	mA
$V_F$	forward voltage drop	$I_F = 10$ A	$T_{VJ} = 25^\circ\text{C}$			1.26	V
		$I_F = 20$ A				1.53	V
		$I_F = 10$ A	$T_{VJ} = 150^\circ\text{C}$			1.21	V
		$I_F = 20$ A				1.57	V
$I_{FAV}$	average forward current	$T_C = 150^\circ\text{C}$ rectangular	$T_{VJ} = 175^\circ\text{C}$ d = 0.5			10	A
$V_{FO}$	threshold voltage	} for power loss calculation only				0.82	V
$r_F$	slope resistance					37	m $\Omega$
$R_{thJC}$	thermal resistance junction to case					1.5	K/W
$R_{thCH}$	thermal resistance case to heatsink				0.25		K/W
$P_{tot}$	total power dissipation			$T_C = 25^\circ\text{C}$		100	W
$I_{FSM}$	max. forward surge current	t = 10 ms; (50 Hz), sine	$T_{VJ} = 45^\circ\text{C}$			120	A
		t = 8,3 ms; (60 Hz), sine	$V_R = 0$ V			130	A
		t = 10 ms; (50 Hz), sine	$T_{VJ} = 150^\circ\text{C}$			100	A
		t = 8,3 ms; (60 Hz), sine	$V_R = 0$ V			110	A
$I^2t$	value for fusing	t = 10 ms; (50 Hz), sine	$T_{VJ} = 45^\circ\text{C}$			72	A <sup>2</sup> s
		t = 8,3 ms; (60 Hz), sine	$V_R = 0$ V			70	A <sup>2</sup> s
		t = 10 ms; (50 Hz), sine	$T_{VJ} = 150^\circ\text{C}$			50	A <sup>2</sup> s
		t = 8,3 ms; (60 Hz), sine	$V_R = 0$ V			50	A <sup>2</sup> s
$C_J$	junction capacitance	$V_R = 400$ V; f = 1 MHz	$T_{VJ} = 25^\circ\text{C}$		4		pF



Package TO-263 (D2Pak-HV)			Ratings			
Symbol	Definition	Conditions	min.	typ.	max.	Unit
$I_{RMS}$	RMS current	per terminal			25	A
$T_{VJ}$	virtual junction temperature		-55		175	°C
$T_{op}$	operation temperature		-55		150	°C
$T_{stg}$	storage temperature		-55		150	°C
<b>Weight</b>				1.5		g
$F_C$	mounting force with clip		20		60	N
$d_{Spp/App}$	creepage distance on surface / striking distance through air	terminal to terminal	4.2			mm
$d_{Spb/Apb}$		terminal to backside	4.7			mm

**Product Marking**



**Part description**

- D = Diode
- M = Standard Rectifier
- A = (up to 1800V)
- 10 = Current Rating [A]
- IM = Single Diode
- 1600 = Reverse Voltage [V]
- PZ = TO-263AB (D2Pak) (2HV)

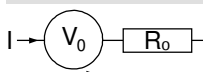
Ordering	Ordering Number	Marking on Product	Delivery Mode	Quantity	Code No.
Standard	DMA10IM1600PZ-TRL	DMA10IM1600PZ	Tape & Reel	800	517581
Alternative	DMA10IM1600PZ-TUB	DMA10IM1600PZ	Tube	50	525333

Similar Part	Package	Voltage class
DMA10I1600PA	TO-220AC (2)	1600

**Equivalent Circuits for Simulation**

\* on die level

$T_{VJ} = 175\text{°C}$

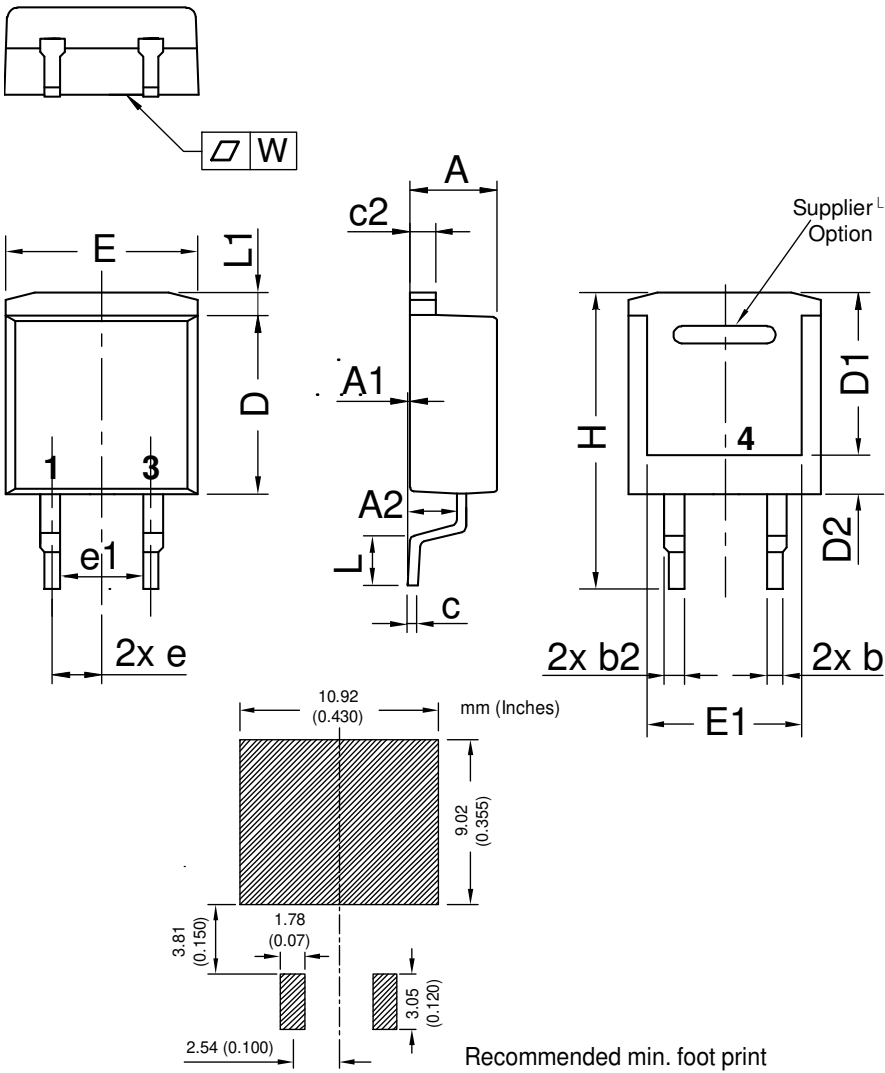


**Rectifier**

$V_{0\ max}$	threshold voltage	0.82	V
$R_{0\ max}$	slope resistance *	34	mΩ

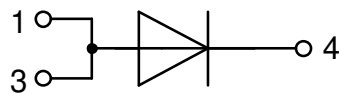


**Outlines TO-263 (D2Pak-HV)**



Dim.	Millimeter		Inches	
	min	max	min	max
A	4.06	4.83	0.160	0.190
A1	typ. 0.10		typ. 0.004	
A2	2.41		0.095	
b	0.51	0.99	0.020	0.039
b2	1.14	1.40	0.045	0.055
c	0.40	0.74	0.016	0.029
c2	1.14	1.40	0.045	0.055
D	8.38	9.40	0.330	0.370
D1	8.00	8.89	0.315	0.350
D2	2.3		0.091	
E	9.65	10.41	0.380	0.410
E1	6.22	8.50	0.245	0.335
e	2,54 BSC		0,100 BSC	
e1	4.28		0.169	
H	14.61	15.88	0.575	0.625
L	1.78	2.79	0.070	0.110
L1	1.02	1.68	0.040	0.066
W	typ. 0.02	0.040	typ. 0.0008	0.002

*All dimensions conform with and/or within JEDEC standard.*



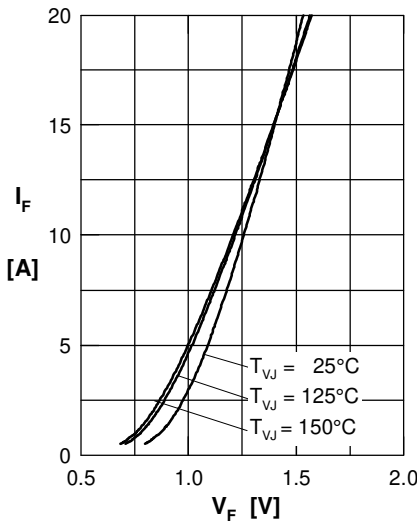
**Rectifier**


Fig. 1 Forward current versus voltage drop per diode

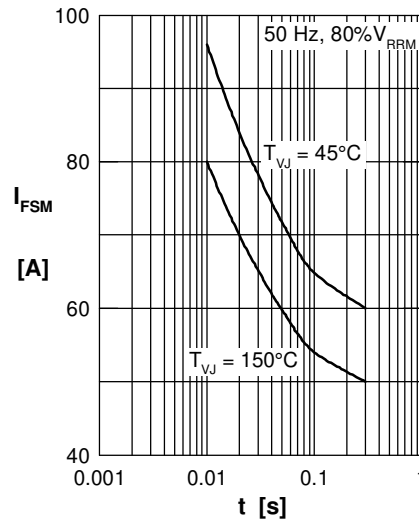


Fig. 2 Surge overload current

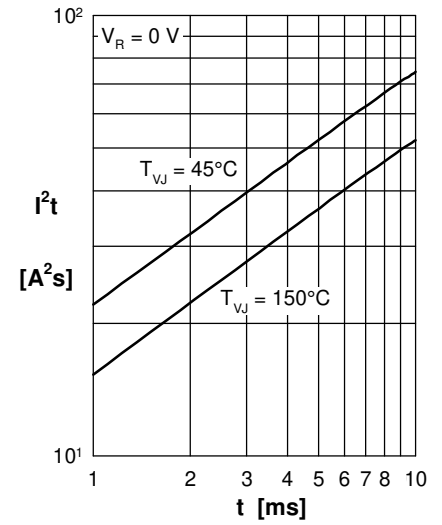
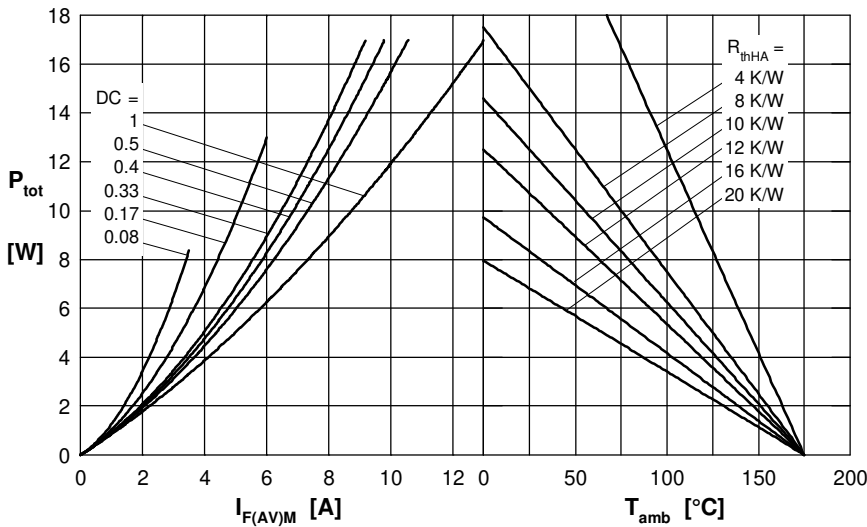

 Fig. 3  $I^2t$  versus time per diode


Fig. 4 Power dissipation vs. direct output current and ambient temperature

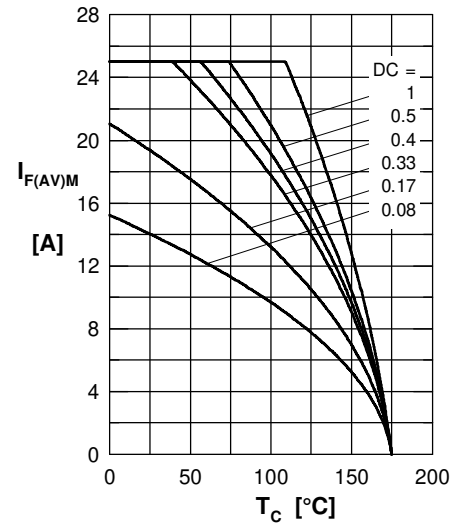


Fig. 5 Max. forward current vs. case temperature

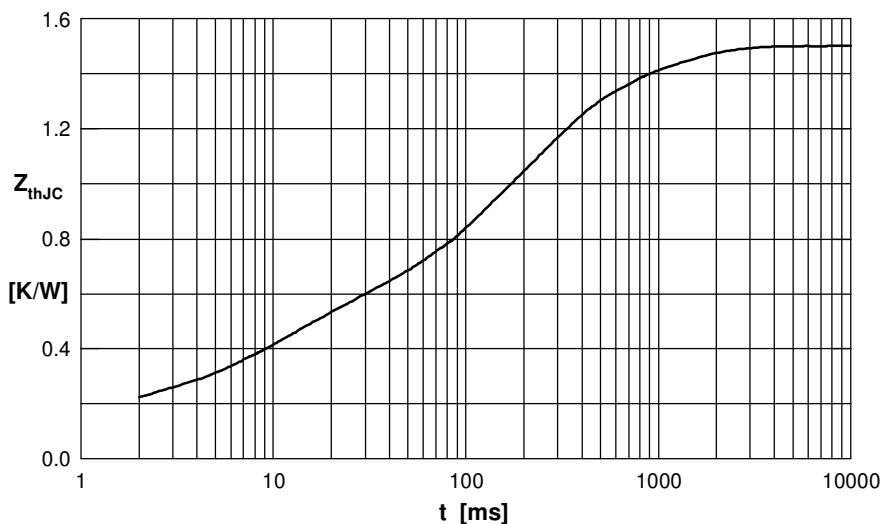


Fig. 6 Transient thermal impedance junction to case

 Constants for  $Z_{thJC}$  calculation:

i	$R_{thi}$ (K/W)	$t_i$ (s)
1	0.155	0.0005
2	0.332	0.0095
3	0.713	0.17
4	0.3	0.8