

High Efficiency Standard Rectifier

$$V_{RRM} = 800 \text{ V}$$

$$I_{FAV} = 10 \text{ A}$$

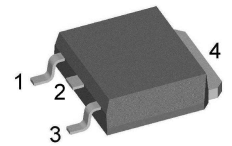
$$V_F = 1.16 \text{ V}$$

Single Diode

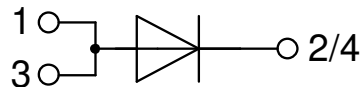
Part number

DLA10IM800UC

Marking on Product: MARLUI



Backside: cathode



Features / Advantages:

- Planar passivated chips
- Very low leakage current
- Very low forward voltage drop
- Improved thermal behaviour

Applications:

- Diode for main rectification
- For single and three phase bridge configurations

Package: TO-252 (DPak)

- Industry standard outline
- RoHS compliant
- Epoxy meets UL 94V-0

Disclaimer Notice

Information furnished is believed to be accurate and reliable. However, users should independently evaluate the suitability of and test each product selected for their own applications. Littelfuse products are not designed for, and may not be used in, all applications. Read complete Disclaimer Notice at www.littelfuse.com/disclaimer-electronics.



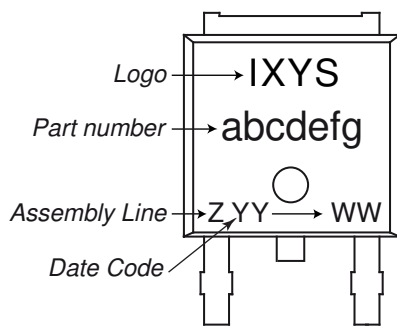
Rectifier				Ratings			
Symbol	Definition	Conditions		min.	typ.	max.	Unit
V_{RSM}	max. non-repetitive reverse blocking voltage					900	V
V_{RRM}	max. repetitive reverse blocking voltage					800	V
I_R	reverse current	$V_R = 800\text{ V}$	$T_{VJ} = 25^\circ\text{C}$			5	μA
		$V_R = 800\text{ V}$	$T_{VJ} = 150^\circ\text{C}$			0.05	mA
V_F	forward voltage drop	$I_F = 10\text{ A}$	$T_{VJ} = 25^\circ\text{C}$			1.22	V
						1.40	V
		$I_F = 20\text{ A}$	$T_{VJ} = 150^\circ\text{C}$			1.16	V
						1.45	V
I_{FAV}	average forward current	$T_C = 145^\circ\text{C}$ rectangular	$T_{VJ} = 175^\circ\text{C}$			10	A
V_{FO}	threshold voltage	} for power loss calculation only				0.84	V
r_F	slope resistance					30	m Ω
R_{thJC}	thermal resistance junction to case					2	K/W
R_{thCH}	thermal resistance case to heatsink				0.50		K/W
P_{tot}	total power dissipation			$T_C = 25^\circ\text{C}$		75	W
I_{FSM}	max. forward surge current	$t = 10\text{ ms}; (50\text{ Hz}), \text{ sine}$	$T_{VJ} = 45^\circ\text{C}$			120	A
		$t = 8,3\text{ ms}; (60\text{ Hz}), \text{ sine}$	$V_R = 0\text{ V}$			130	A
		$t = 10\text{ ms}; (50\text{ Hz}), \text{ sine}$	$T_{VJ} = 150^\circ\text{C}$			100	A
		$t = 8,3\text{ ms}; (60\text{ Hz}), \text{ sine}$	$V_R = 0\text{ V}$			110	A
I^2t	value for fusing	$t = 10\text{ ms}; (50\text{ Hz}), \text{ sine}$	$T_{VJ} = 45^\circ\text{C}$			72	A ² s
		$t = 8,3\text{ ms}; (60\text{ Hz}), \text{ sine}$	$V_R = 0\text{ V}$			70	A ² s
		$t = 10\text{ ms}; (50\text{ Hz}), \text{ sine}$	$T_{VJ} = 150^\circ\text{C}$			50	A ² s
		$t = 8,3\text{ ms}; (60\text{ Hz}), \text{ sine}$	$V_R = 0\text{ V}$			50	A ² s
C_J	junction capacitance	$V_R = 400\text{ V}; f = 1\text{ MHz}$	$T_{VJ} = 25^\circ\text{C}$		3		pF



Package TO-252 (DPak)			Ratings			
Symbol	Definition	Conditions	min.	typ.	max.	Unit
I_{RMS}	RMS current	per terminal ¹⁾			20	A
T_{VJ}	virtual junction temperature		-55		175	°C
T_{op}	operation temperature		-55		150	°C
T_{stg}	storage temperature		-55		150	°C
Weight				0.3		g
F_C	mounting force with clip		20		60	N

¹⁾ I_{RMS} is typically limited by the pin-to-chip resistance (1); or by the current capability of the chip (2). In case of (1) and a product with multiple pins for one chip-potential, the current capability can be increased by connecting the pins as one contact.

Product Marking



Part description

- D = Diode
- L = High Efficiency Standard Rectifier
- A = (up to 1200V)
- 10 = Current Rating [A]
- IM = Single Diode
- 800 = Reverse Voltage [V]
- UC = TO-252AA (DPak)

Ordering	Ordering Number	Marking on Product	Delivery Mode	Quantity	Code No.
Standard	DLA10IM800UC-TRL	MARLUI	Tape & Reel	2500	503668
Alternative	DLA10IM800UC-TUB	MARLUI	Tube	70	523435

Equivalent Circuits for Simulation

* on die level

$T_{VJ} = 175\text{ °C}$

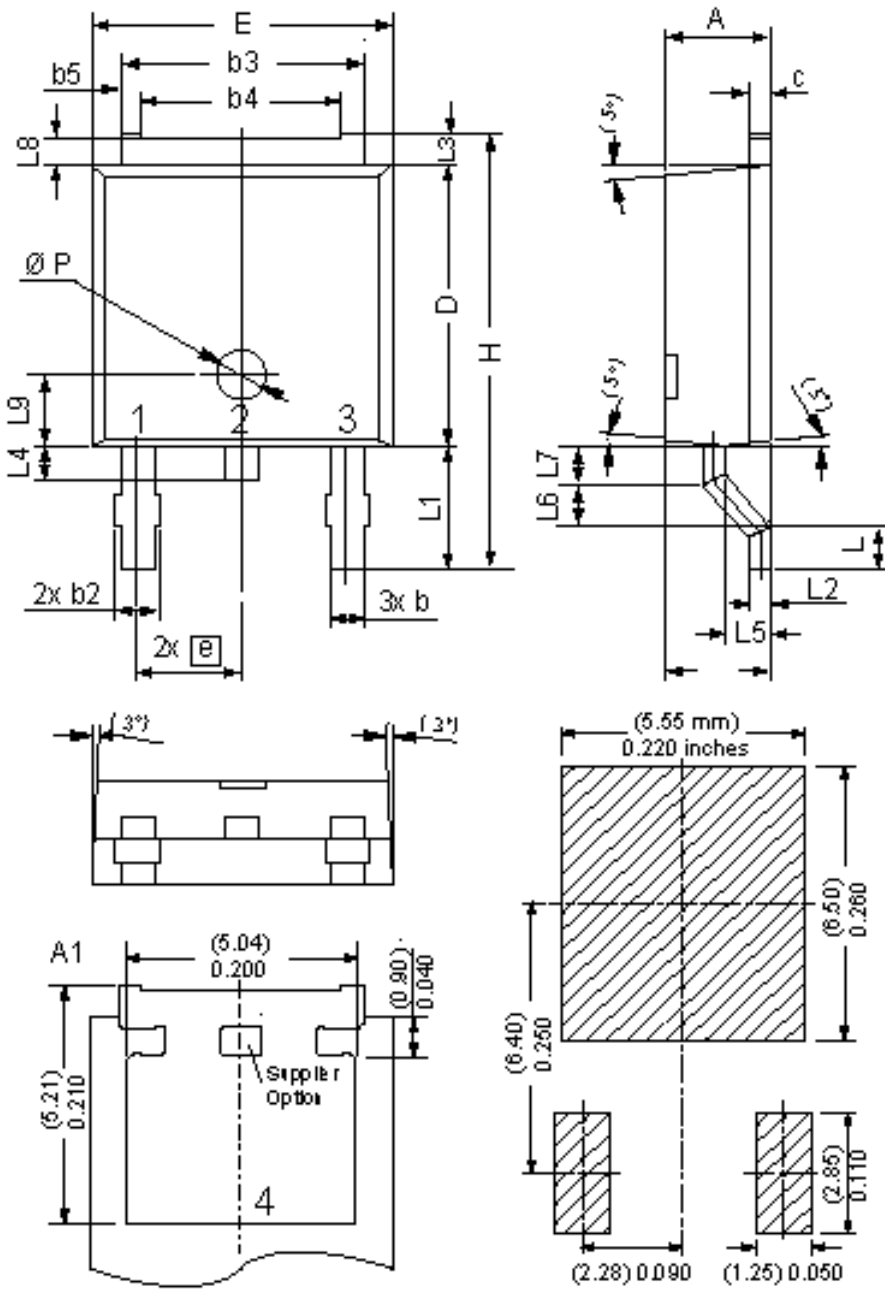


Rectifier

$V_{0\ max}$	threshold voltage	0.84	V
$R_{0\ max}$	slope resistance *	27	mΩ

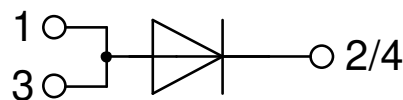


Outlines TO-252 (DPak)



Dim	Millimeters		Inches	
	min	max	min	max
A	2.20	2.40	0.087	0.094
A1	2.10	2.50	0.083	0.098
b	0.66	0.86	0.026	0.034
b2	-	0.96	-	0.038
b3	5.04	5.64	0.198	0.222
b4	4.34	BSC	0.171	BSC
b5	0.50	BSC	0.020	BSC
c	0.40	0.86	0.016	0.034
D	5.90	6.30	0.232	0.248
E	6.40	6.80	0.252	0.268
e	2.10	2.50	0.083	0.098
H	9.20	10.10	0.362	0.398
L	0.55	1.28	0.022	0.050
L1	2.50	2.90	0.098	0.114
L2	0.40	0.60	0.016	0.024
L3	0.50	0.90	0.020	0.035
L4	0.60	1.00	0.024	0.039
L5	0.82	1.22	0.032	0.048
L6	0.79	0.99	0.031	0.039
L7	0.81	1.01	0.032	0.040
L8	0.40	0.80	0.016	0.031
L9	1.50	BSC	0.059	BSC
Ø P	1.00	BSC	0.039	BSC

Recommended
min. foot print



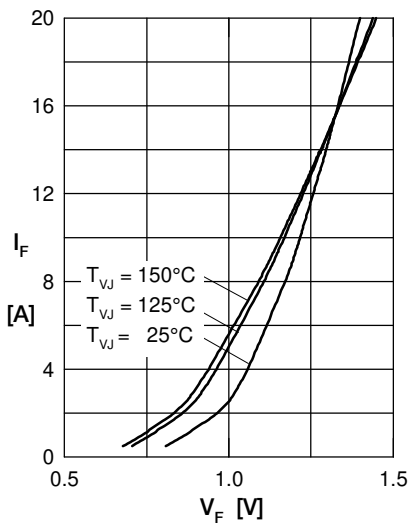
Rectifier


Fig. 1 Forward current versus voltage drop

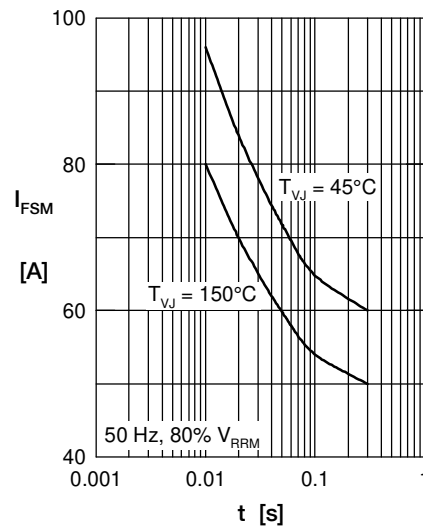


Fig. 2 Surge overload current

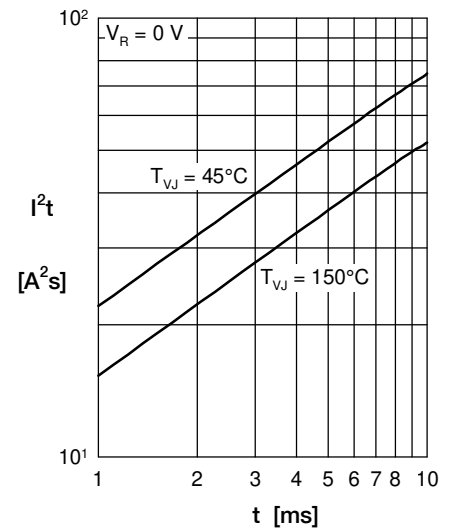
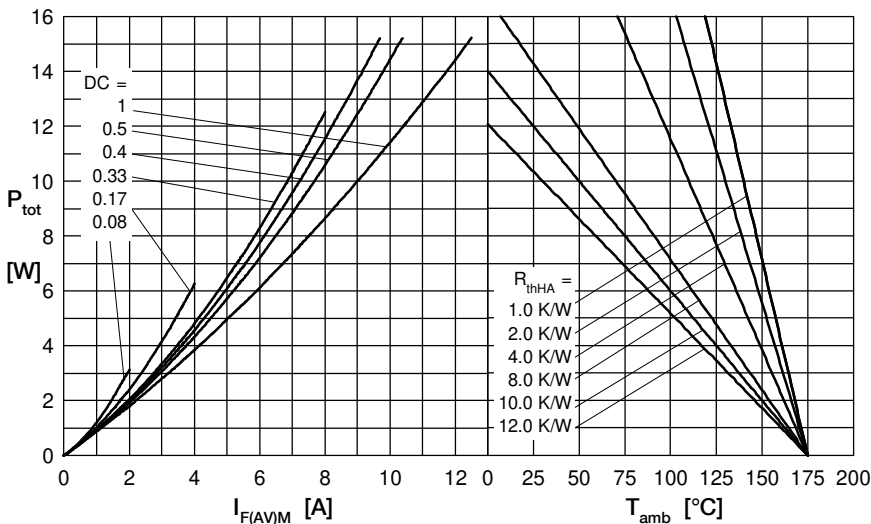

 Fig. 3 I^2t versus time


Fig. 4 Power dissipation versus direct output current and ambient temperature

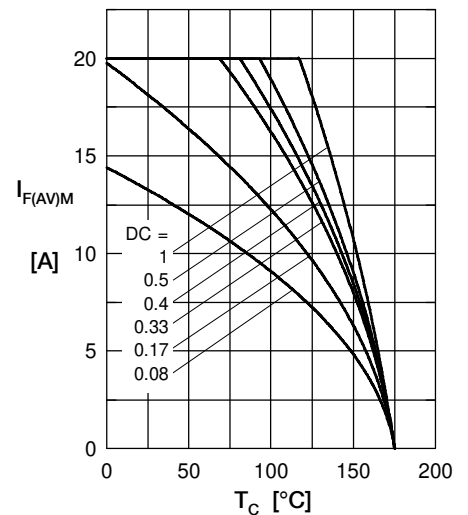


Fig. 5 Max. forward current vs. case temperature

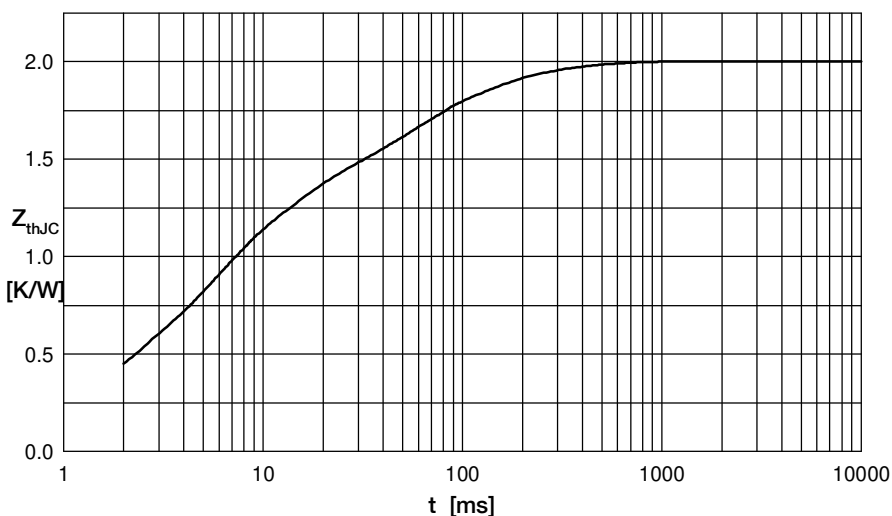


Fig. 6 Transient thermal impedance junction to case

 Constants for Z_{thJC} calculation:

i	R_{thi} (K/W)	t_i (s)
1	1.1	0.005
2	0.06	0.0003
3	0.14	0.045
4	0.2	0.2
5	0.5	0.05