

Low Voltage Standard Rectifier

$$V_{RRM} = 1200\text{ V}$$

$$I_{FAV} = 100\text{ A}$$

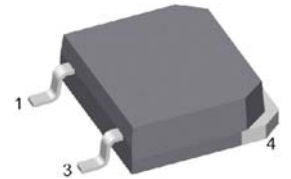
$$V_F = 1,32\text{ V}$$

Single Diode

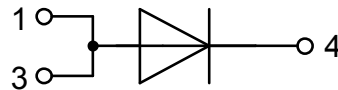
Part number

DLA100IM1200TZ

Marking on Product: *DLA100IM1200TZ*



Backside: cathode



Features / Advantages:

- Planar passivated chips
- Very low leakage current
- Very low forward voltage drop
- Improved thermal behaviour
- High commutation robustness
- High surge capability

Applications:

- Diode for main rectification
- For single and three phase bridge configurations

Package: TO-268AA (D3Pak-HV)

- Industry standard outline
- RoHS compliant
- Epoxy meets UL 94V-0
- High creepage distance between terminals

Disclaimer Notice

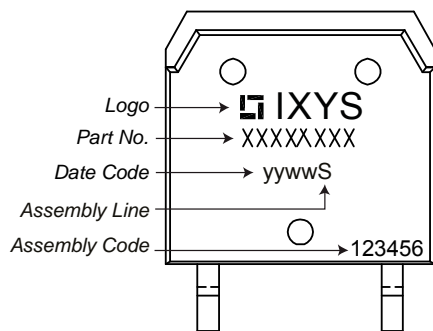
Information furnished is believed to be accurate and reliable. However, users should independently evaluate the suitability of and test each product selected for their own applications. Littelfuse products are not designed for, and may not be used in, all applications. Read complete Disclaimer Notice at www.littelfuse.com/disclaimer-electronics.

Rectifier			Ratings			
Symbol	Definition	Conditions	min.	typ.	max.	Unit
V_{RSM}	max. non-repetitive reverse blocking voltage	$T_{VJ} = 25^{\circ}C$			1300	V
V_{RRM}	max. repetitive reverse blocking voltage	$T_{VJ} = 25^{\circ}C$			1200	V
I_R	reverse current	$V_R = 1200 V$	$T_{VJ} = 25^{\circ}C$		20	μA
		$V_R = 1200 V$	$T_{VJ} = 150^{\circ}C$		0,1	mA
V_F	forward voltage drop	$I_F = 100 A$	$T_{VJ} = 25^{\circ}C$		1,34	V
					1,68	V
		$I_F = 200 A$	$T_{VJ} = 150^{\circ}C$		1,32	V
					1,75	V
I_{FAV}	average forward current	$T_C = 105^{\circ}C$ 180° sine	$T_{VJ} = 175^{\circ}C$		100	A
V_{F0}	threshold voltage	} for power loss calculation only	$T_{VJ} = 175^{\circ}C$		0,85	V
r_F	slope resistance				4,6	m Ω
R_{thJC}	thermal resistance junction to case				0,35	K/W
R_{thCH}	thermal resistance case to heatsink			0,15		K/W
P_{tot}	total power dissipation		$T_C = 25^{\circ}C$		430	W
I_{FSM}	max. forward surge current	t = 10 ms; (50 Hz), sine	$T_{VJ} = 45^{\circ}C$		1,30	kA
		t = 8,3 ms; (60 Hz), sine	$V_R = 0 V$		1,41	kA
		t = 10 ms; (50 Hz), sine	$T_{VJ} = 150^{\circ}C$		1,11	kA
		t = 8,3 ms; (60 Hz), sine	$V_R = 0 V$		1,20	kA
I^2t	value for fusing	t = 10 ms; (50 Hz), sine	$T_{VJ} = 45^{\circ}C$		8,45	kA ² s
		t = 8,3 ms; (60 Hz), sine	$V_R = 0 V$		8,21	kA ² s
		t = 10 ms; (50 Hz), sine	$T_{VJ} = 150^{\circ}C$		6,11	kA ² s
		t = 8,3 ms; (60 Hz), sine	$V_R = 0 V$		5,94	kA ² s
C_J	junction capacitance	$V_R = 400 V$; f = 1 MHz	$T_{VJ} = 25^{\circ}C$		43	pF



Package TO-268AA (D3Pak-HV)			Ratings			
Symbol	Definition	Conditions	min.	typ.	max.	Unit
I_{RMS}	RMS current	per terminal			70	A
T_{VJ}	virtual junction temperature		-55		175	°C
T_{op}	operation temperature		-55		150	°C
T_{stg}	storage temperature		-55		150	°C
Weight				4		g
F_C	mounting force with clip		20		120	N
$d_{Spp/App}$	creepage distance on surface striking distance through air	terminal to terminal	9,4			mm
$d_{Spb/Apb}$		terminal to backside	5,6			mm

Product Marking



Part description

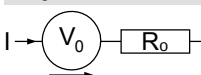
- D = Diode
- L = Low Voltage Standard Rectifier
- A = (up to 1200V)
- 100 = Current Rating [A]
- IM = Single Diode
- 1200 = Reverse Voltage [V]
- TZ = TO-268AA (D3Pak) (2HV)

Ordering	Ordering Number	Marking on Product	Delivery Mode	Quantity	Code No.
Standard		DLA100IM1200TZ			

Equivalent Circuits for Simulation

* on die level

$T_{VJ} = 175^{\circ}C$

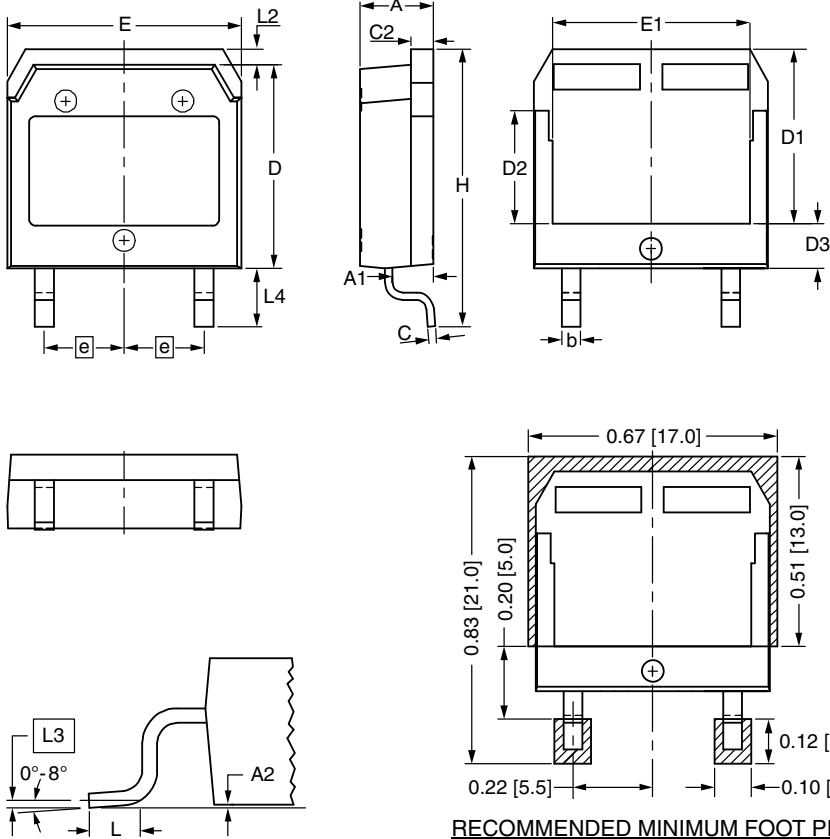


Rectifier

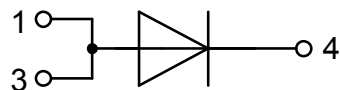
$V_{0\ max}$	threshold voltage	0,85	V
$R_{0\ max}$	slope resistance *	2,6	mΩ



Outlines TO-268AA (D3Pak-HV)



Dim.	Millimeter		Inches	
	min	max	min	max
A	4.90	5.10	0.193	0.201
A1	2.70	2.90	0.106	0.114
A2	0.02	0.25	0.001	0.010
b	1.15	1.45	0.045	0.057
C	0.40	0.65	0.016	0.026
C2	1.45	1.60	0.057	0.063
D	13.80	14.00	0.543	0.551
D1	11.80	12.10	0.465	0.476
D2	7.50	7.80	0.295	0.307
D3	2.90	3.20	0.114	0.126
E	15.85	16.05	0.624	0.632
E1	13.30	13.60	0.524	0.535
e	5.450 BSC		0.215 BSC	
H	18.70	19.10	0.736	0.752
L	1.70	2.00	0.067	0.079
L2	1.00	1.15	0.039	0.045
L3	0.250 BSC		0.010 BSC	
L4	3.80	4.10	0.150	0.161



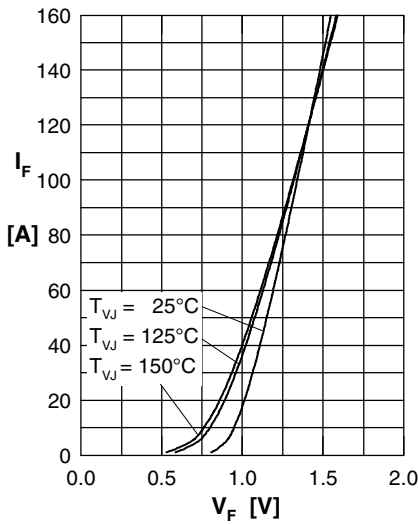
Rectifier


Fig. 1 Forward current versus voltage drop per diode

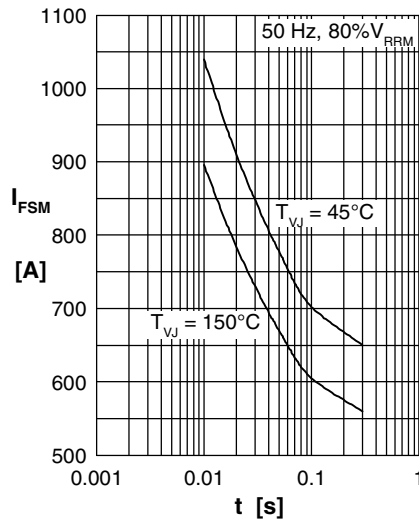


Fig. 2 Surge overload current versus time per diode

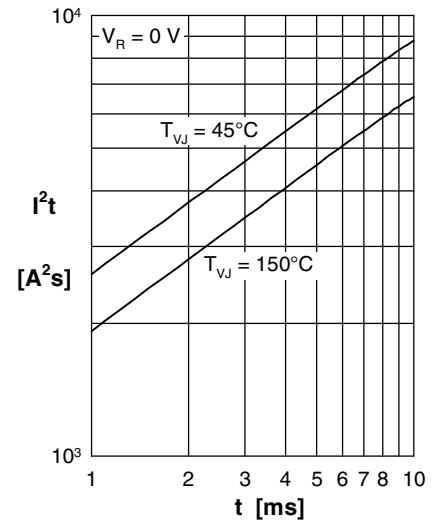
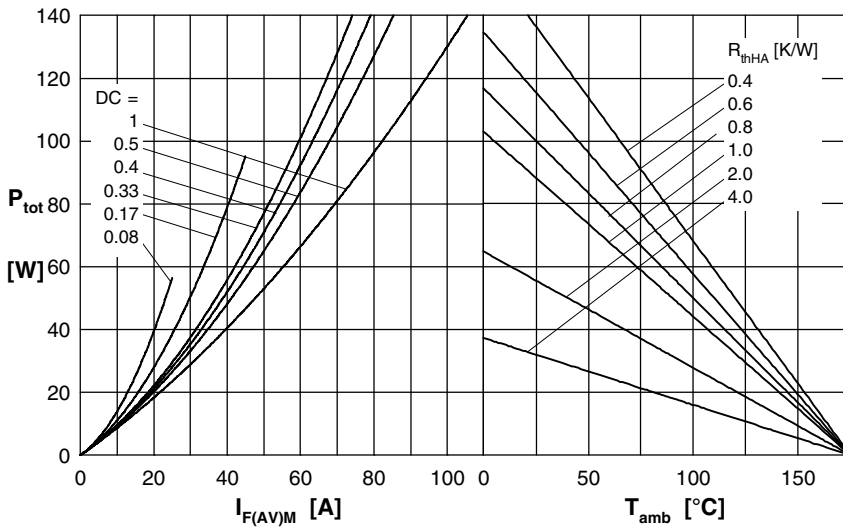

 Fig. 3 I^2t versus time per diode


Fig. 4 Power dissipation versus direct output current and ambient temperature per diode

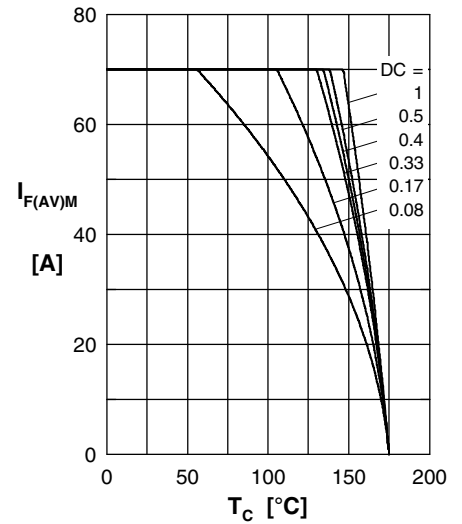


Fig. 5 Max. forward current versus case temperature per diode

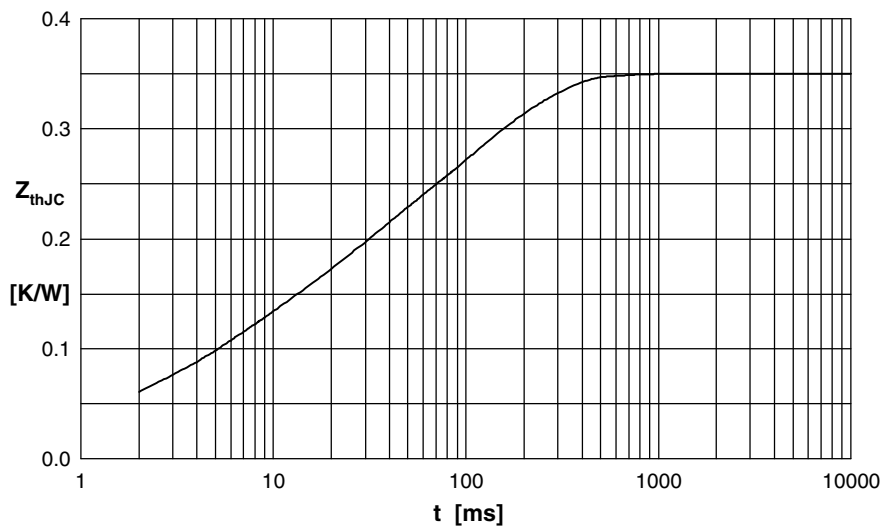


Fig. 6 Transient thermal impedance junction to case versus time per diode

 Constants for Z_{thJC} calculation:

i	R_{thi} (K/W)	t_i (s)
1	0.023	0.0006
2	0.065	0.0038
3	0.094	0.0190
4	0.168	0.1300