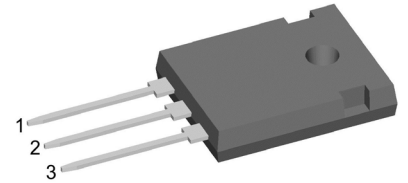


SiC Schottky Diode

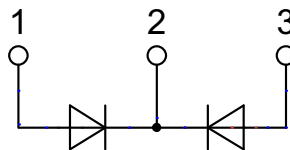
 $V_{RRM} = 1200\text{ V}$
 $I_{FAV} = 2 \times 12.5\text{ A}$

Ultra fast switching
 Zero reverse recovery
 Common Cathode

Part number
DCG20C1200HR



Backside: isolated

Features / Advantages:

- Ultra fast switching
- Zero reverse recovery
- Zero forward recovery
- Temperature independent switching behavior
- Positive temperature coefficient of forward voltage
- $T_{VJM} = 175^{\circ}\text{C}$

Applications:

- Solar inverter
- Uninterruptible power supply (UPS)
- Welding equipment
- Switched-mode power supplies
- Medical equipment
- High speed rectifier

Package: ISO247

- Isolation Voltage: 3000 V~
- Industry standard outline
- RoHS compliant
- Epoxy meets UL 94V-0
- Soldering pins for PCB mounting
- Backside: DCB ceramic
- Reduced weight
- Advanced power cycling

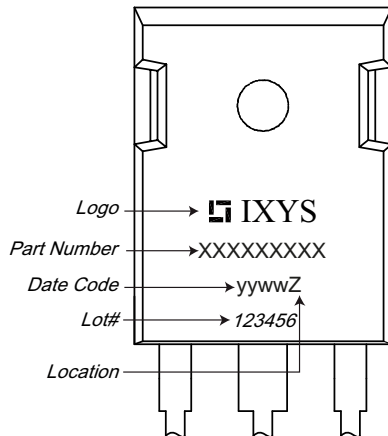
Disclaimer Notice

Information furnished is believed to be accurate and reliable. However, users should independently evaluate the suitability of and test each product selected for their own applications. Littelfuse products are not designed for, and may not be used in, all applications. Read complete Disclaimer Notice Disclaimer Notice at www.littelfuse.com/disclaimer-electronics.

SiC Diode (per diode)				Ratings				
Symbol	Definitions	Conditions	min.	typ.	max.			
V_{RSM}	max. non-repetitive reverse blocking voltage				1200	V		
V_{RRM}	max. repetitive reverse blocking voltage				1200	V		
I_R	reverse current	$V_R = V_{RRM}$	$T_{VJ} = 25^\circ\text{C}$		30	250	μA	
			$T_{VJ} = 175^\circ\text{C}$		55	350	μA	
V_F	forward voltage	$I_F = 10\text{ A}$ $I_F = 20\text{ A}$	$T_{VJ} = 25^\circ\text{C}$		1.5	1.8	V	
			$T_{VJ} = 175^\circ\text{C}$		2.2	3.0	V	
		$I_F = 10\text{ A}$ $I_F = 20\text{ A}$	$T_{VJ} = 175^\circ\text{C}$					V
								V
I_{FAV}	average forward current	$T_C = 80^\circ\text{C}$ $T_C = 100^\circ\text{C}$	rectangular, d = 0.5 $T_{VJ} = 175^\circ\text{C}$		12.5	A		
					11.0	A		
I_{F25}	forward current	based on typ. V_{F0} and r_F	$T_C = 25^\circ\text{C}$		22	A		
I_{F80}			$T_C = 80^\circ\text{C}$		17	A		
I_{F100}			$T_C = 100^\circ\text{C}$		15	A		
I_{FSM}	max forward surge current	t = 10 ms, half sine (50 Hz) $t_p = 10\ \mu\text{s}$, pulse	$T_{VJ} = 25^\circ\text{C}$ $V_R = 0\text{V}$			A		
					750	A		
V_{F0}	threshold voltage	} for power loss calculation	$T_{VJ} = 125^\circ\text{C}$		0.77	V		
r_F	slope resistance		$T_{VJ} = 175^\circ\text{C}$		0.69	V		
			$T_{VJ} = 125^\circ\text{C}$		107	$\text{m}\Omega$		
			$T_{VJ} = 175^\circ\text{C}$		133	$\text{m}\Omega$		
Q_C	total capacitive charge	$V_R = 800\text{ V}$, $I_F = 10\text{ A}$ $di/dt = 200\text{ A}/\mu\text{s}$	$T_{VJ} = 25^\circ\text{C}$		52	nC		
C	total capacitance	$V_R = 0\text{ V}$ $V_R = 400\text{ V}$ $V_R = 800\text{ V}$	$T_{VJ} = 25^\circ\text{C}$, f = 1 MHz		755	pF		
					45	pF		
					38	pF		
R_{thJC}	thermal resistance junction to case				1.9	K/W		
R_{thJH}	thermal resistance junction to heatsink	with heatsink compound; IXYS test setup			2.2	K/W		

Package ISO247				Ratings		
Symbol	Definitions	Conditions	min.	typ.	max.	
I_{RMS}	RMS current	per terminal			70	A
T_{stg}	storage temperature		-40		150	°C
T_{op}	operation temperature		-40		150	°C
T_{VJ}	virtual junction temperature		-40		175	°C
Weight				6		g
M_D	mounting torque		0.8		1.2	Nm
F_C	mounting force with clip		40		120	N
$d_{Spp/App}$	creepage distance on surface /	terminal to terminal	2.7			mm
$d_{Spb/Appb}$	striking distance through air	terminal to backside	4.1			mm
V_{ISOL}	isolation voltage	$t = 1$ second $t = 1$ minute		3600 3000		V V
		50/60 Hz; RMS; $I_{ISOL} < 1$ mA				

Product Marking

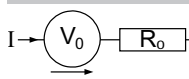


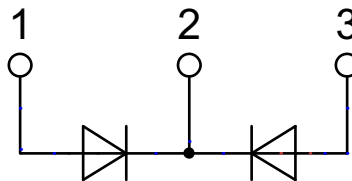
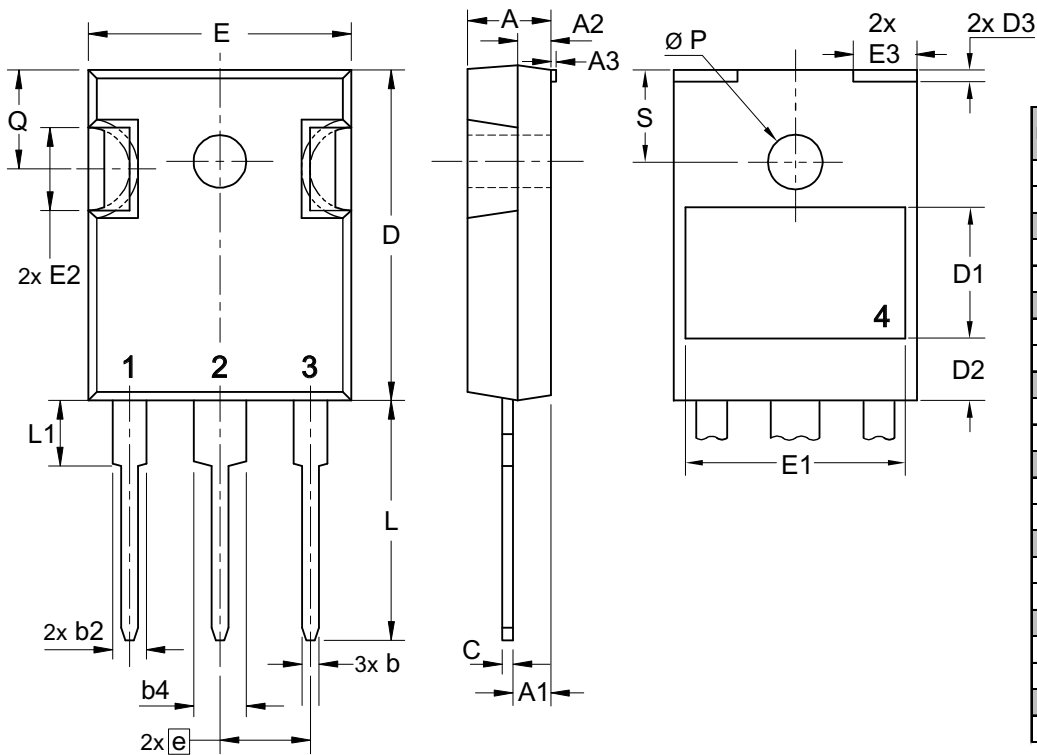
Part description

D = Diode
 C = SiC
 G = Extreme fast
 20 = Current Rating [A]
 C = Common Cathode
 1200 = Reverse Voltage [V]
 HR = ISO247 (3)

Ordering	Part Name	Marking on Product	Delivering Mode	Base Qty	Ordering Code
Standard	DCG20C1200HR	DCG20C1200HR	Tube	30	DCG20C1200HR

Equivalent Circuits for Simulation *on die level, typical

		$T_{VJ} = 125^\circ\text{C}$	$T_{VJ} = 175^\circ\text{C}$	
$V_{0\max}$	threshold voltage	0.77	0.68	V
$R_{0\max}$	slope resistance *	107	133	mΩ

Outlines ISO247


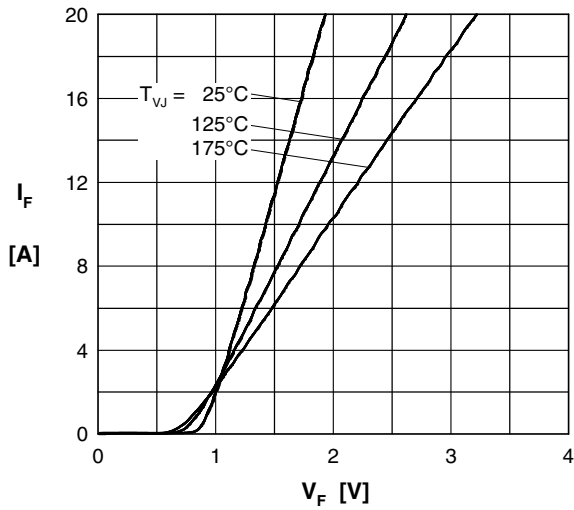
SiC Diode (per diode)


Fig. 1 Typ. forward characteristics.

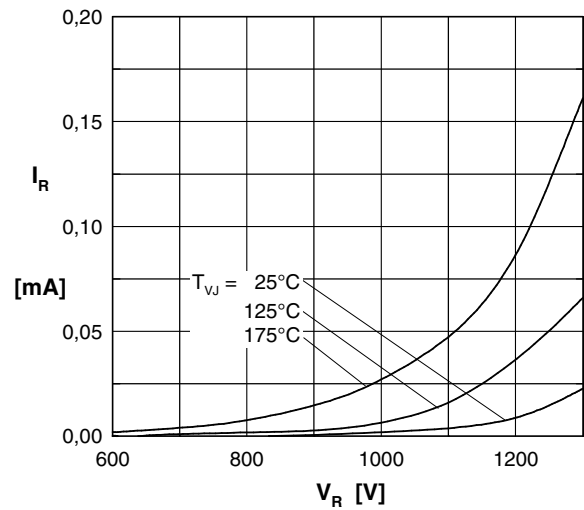


Fig. 2 Typ. reverse characteristics

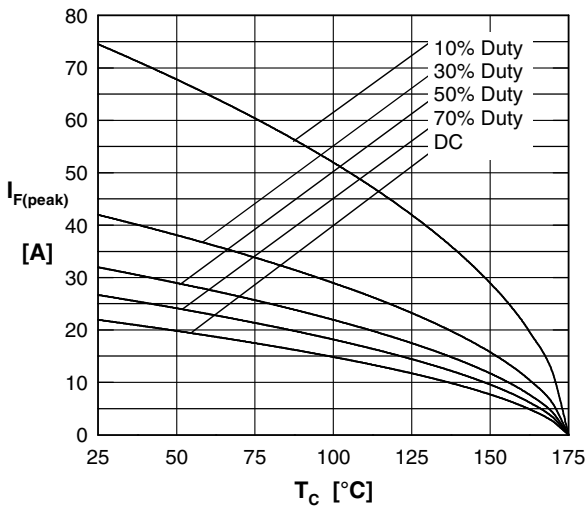


Fig. 3 Typ. current derating

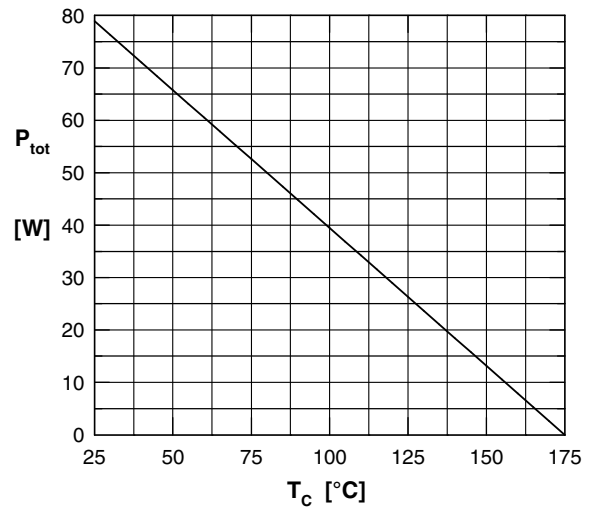


Fig. 4 Power derating

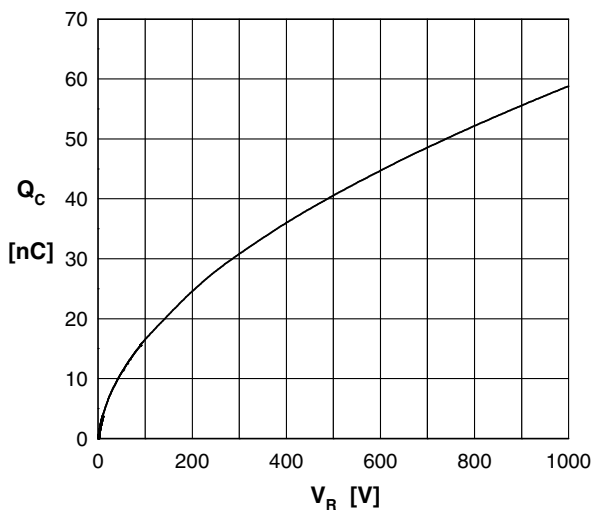


Fig. 5 Typ. recovery charge vs. reverse voltage

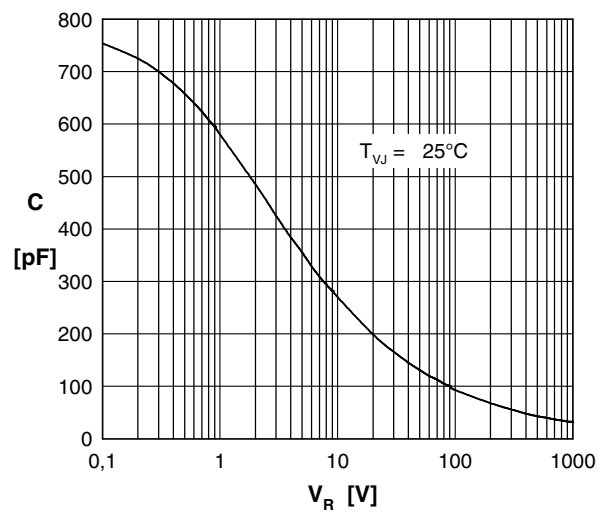


Fig. 6 Typ. junction capacitance vs. reverse Voltage

SiC Diode (per diode)

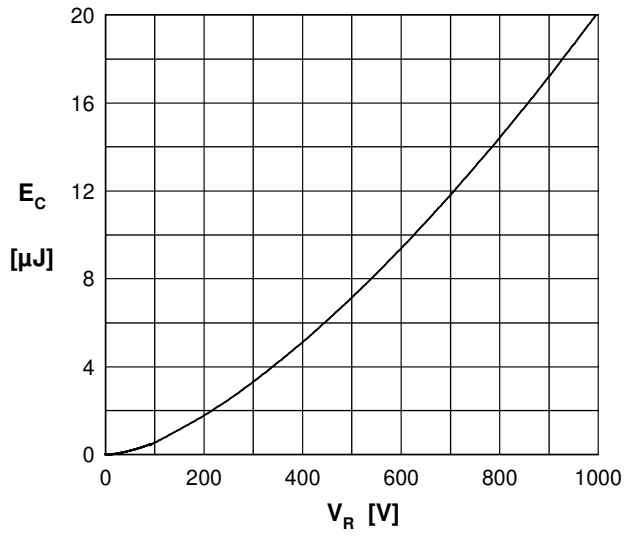


Fig. 7 Typical capacitance stored energy

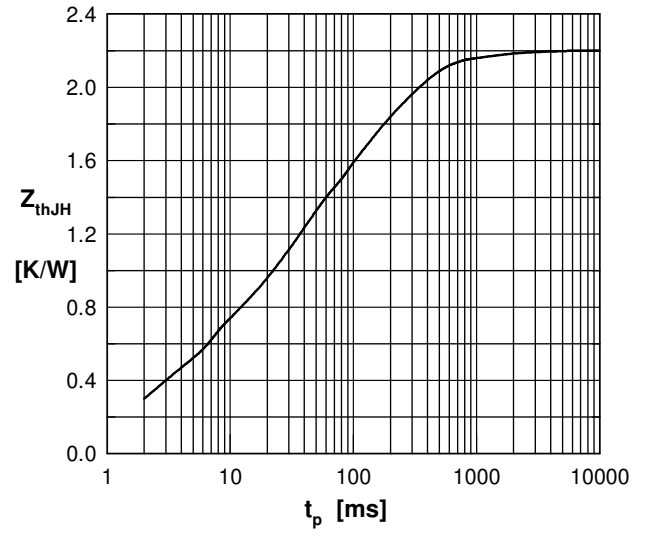


Fig. 8 Typ. transient thermal impedance junction to heatsink