

High Efficiency Thyristor

3~ Rectifier	
V_{RRM}	= 1200 V
I_{DAV}	= 90 A
I_{FSM}	= 350 A

SemiFast
 3~ Rectifier Bridge, half-controlled (high-side)

Part number

CLE90UH1200TLB

Marking on Product: CLE90UH1200TLB

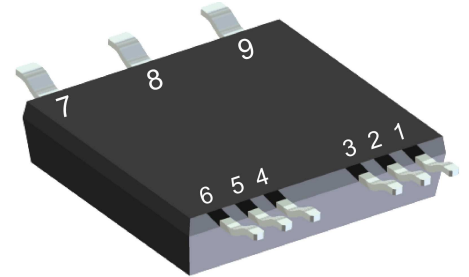

Backside: isolated

 E72873

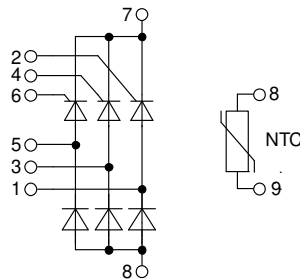

Features / Advantages:

- Thyristor for line and moderate frequencies
- Short turn-off time
- Planar passivated chip
- Long-term stability

Applications:

- Line rectifying 50/60 Hz
- Drives
- SMPS
- UPS

Package: SMPD

- Isolation Voltage: 3000 V~
- Industry convenient outline
- RoHS compliant
- Epoxy meets UL 94V-0
- Soldering pins for PCB mounting
- Backside: DCB ceramic
- Reduced weight
- Advanced power cycling

Disclaimer Notice

Information furnished is believed to be accurate and reliable. However, users should independently evaluate the suitability of and test each product selected for their own applications. Littelfuse products are not designed for, and may not be used in, all applications. Read complete Disclaimer Notice at www.littelfuse.com/disclaimer-electronics.

Rectifier			Ratings			
Symbol	Definition	Conditions	min.	typ.	max.	Unit
$V_{RSM/DSM}$	max. non-repetitive reverse/forward blocking voltage	$T_{VJ} = 25^{\circ}\text{C}$			1200	V
$V_{RRM/DRM}$	max. repetitive reverse/forward blocking voltage	$T_{VJ} = 25^{\circ}\text{C}$			1200	V
I_{RD}	reverse current, drain current	$V_{R/D} = 1200\text{ V}$	$T_{VJ} = 25^{\circ}\text{C}$		10	μA
		$V_{R/D} = 1200\text{ V}$	$T_{VJ} = 125^{\circ}\text{C}$		2	mA
V_T	forward voltage drop	$I_T = 30\text{ A}$	$T_{VJ} = 25^{\circ}\text{C}$		1.30	V
		$I_T = 90\text{ A}$			1.80	V
		$I_T = 30\text{ A}$	$T_{VJ} = 125^{\circ}\text{C}$		1.28	V
		$I_T = 90\text{ A}$			1.95	V
I_{DAV}	bridge output current	$T_C = 90^{\circ}\text{C}$ 120° sine	$T_{VJ} = 150^{\circ}\text{C}$		90	A
V_{T0}	threshold voltage	} for power loss calculation only	$T_{VJ} = 150^{\circ}\text{C}$		0.92	V
r_T	slope resistance				13	m Ω
R_{thJC}	thermal resistance junction to case				0.9	K/W
R_{thCH}	thermal resistance case to heatsink			0.40		K/W
P_{tot}	total power dissipation		$T_C = 25^{\circ}\text{C}$		140	W
I_{TSM}	max. forward surge current	$t = 10\text{ ms}; (50\text{ Hz}), \text{ sine}$	$T_{VJ} = 45^{\circ}\text{C}$		350	A
		$t = 8,3\text{ ms}; (60\text{ Hz}), \text{ sine}$	$V_R = 0\text{ V}$		380	A
		$t = 10\text{ ms}; (50\text{ Hz}), \text{ sine}$	$T_{VJ} = 150^{\circ}\text{C}$		300	A
		$t = 8,3\text{ ms}; (60\text{ Hz}), \text{ sine}$	$V_R = 0\text{ V}$		320	A
I^2t	value for fusing	$t = 10\text{ ms}; (50\text{ Hz}), \text{ sine}$	$T_{VJ} = 45^{\circ}\text{C}$		615	A ² s
		$t = 8,3\text{ ms}; (60\text{ Hz}), \text{ sine}$	$V_R = 0\text{ V}$		600	A ² s
		$t = 10\text{ ms}; (50\text{ Hz}), \text{ sine}$	$T_{VJ} = 150^{\circ}\text{C}$		450	A ² s
		$t = 8,3\text{ ms}; (60\text{ Hz}), \text{ sine}$	$V_R = 0\text{ V}$		425	A ² s
C_J	junction capacitance	$V_R = 400\text{ V}$ $f = 1\text{ MHz}$	$T_{VJ} = 25^{\circ}\text{C}$		13	pF
P_{GM}	max. gate power dissipation	$t_p = 30\text{ }\mu\text{s}$	$T_C = 150^{\circ}\text{C}$		10	W
		$t_p = 300\text{ }\mu\text{s}$			5	W
P_{GAV}	average gate power dissipation				0.5	W
$(di/dt)_{cr}$	critical rate of rise of current	$T_{VJ} = 150^{\circ}\text{C}; f = 50\text{ Hz}$ repetitive, $I_T = 90\text{ A}$			150	A/ μs
		$t_p = 200\text{ }\mu\text{s}; di_G/dt = 0.3\text{ A}/\mu\text{s};$ $I_G = 0.3\text{ A}; V = \frac{2}{3} V_{DRM}$ non-repet., $I_T = 30\text{ A}$			500	A/ μs
$(dv/dt)_{cr}$	critical rate of rise of voltage	$V = \frac{2}{3} V_{DRM}$ $R_{GK} = \infty$; method 1 (linear voltage rise)	$T_{VJ} = 150^{\circ}\text{C}$		500	V/ μs
V_{GT}	gate trigger voltage	$V_D = 6\text{ V}$	$T_{VJ} = 25^{\circ}\text{C}$		1.4	V
			$T_{VJ} = -40^{\circ}\text{C}$		1.7	V
I_{GT}	gate trigger current	$V_D = 6\text{ V}$	$T_{VJ} = 25^{\circ}\text{C}$		30	mA
			$T_{VJ} = -40^{\circ}\text{C}$		50	mA
V_{GD}	gate non-trigger voltage	$V_D = \frac{2}{3} V_{DRM}$	$T_{VJ} = 150^{\circ}\text{C}$		0.2	V
I_{GD}	gate non-trigger current				1	mA
I_L	latching current	$t_p = 10\text{ }\mu\text{s}$	$T_{VJ} = 25^{\circ}\text{C}$		90	mA
		$I_G = 0.3\text{ A}; di_G/dt = 0.3\text{ A}/\mu\text{s}$				
I_H	holding current	$V_D = 6\text{ V}$ $R_{GK} = \infty$	$T_{VJ} = 25^{\circ}\text{C}$		60	mA
t_{gd}	gate controlled delay time	$V_D = \frac{1}{2} V_{DRM}$	$T_{VJ} = 25^{\circ}\text{C}$		2	μs
		$I_G = 0.3\text{ A}; di_G/dt = 0.3\text{ A}/\mu\text{s}$				
t_q	turn-off time	$V_R = 100\text{ V}; I_T = 30\text{ A}; V = \frac{2}{3} V_{DRM}$ $di/dt = 10\text{ A}/\mu\text{s}$ $dv/dt = 20\text{ V}/\mu\text{s}$ $t_p = 200\text{ }\mu\text{s}$	$T_{VJ} = 125^{\circ}\text{C}$		50	μs

Package SMPD		Ratings				
Symbol	Definition	Conditions	min.	typ.	max.	Unit
I_{RMS}	RMS current	per terminal			100	A
T_{VJ}	virtual junction temperature		-55		150	°C
T_{op}	operation temperature		-55		125	°C
T_{stg}	storage temperature		-55		150	°C
Weight				8.5		g
F_C	mounting force with clip		40		130	N
$d_{Spp/App}$	creepage distance on surface / striking distance through air	terminal to terminal	1.6			mm
$d_{Spb/Apb}$		terminal to backside	4.0			mm
V_{ISOL}	isolation voltage	t = 1 second t = 1 minute	3000 2500			V V
		50/60 Hz, RMS; $I_{ISOL} \leq 1$ mA				

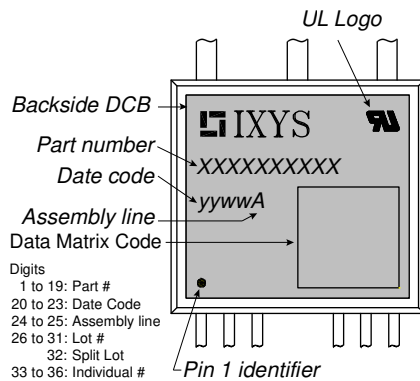
Part description

C = Thyristor (SCR)
 L = High Efficiency Thyristor
 E = Semifast (up to 1200V)
 90 = Current Rating [A]
 UH = 3- Rectifier Bridge, half-controlled (high-side)
 1200 = Reverse Voltage [V]
 T = Thermistor \ Temperature sensor
 LB = SMPD-B

Ordering	Ordering Number	Marking on Product	Delivery Mode	Quantity	Code No.
Standard	CLE90UH1200TLB-TUB	CLE90UH1200TLB	Tube	20	517456
Alternative	CLE90UH1200TLB-TRR	CLE90UH1200TLB	Tape & Reel	200	517463

Temperature Sensor NTC

Symbol	Definition	Conditions	min.	typ.	max.	Unit
R_{25}	resistance	$T_{VJ} = 25^\circ$	4.75	5	5.25	k Ω
$B_{25/50}$	temperature coefficient			3375		K

Equivalent Circuits for Simulation

* on die level

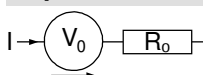
 $T_{VJ} = 150^\circ\text{C}$

Thyristor

$V_{0\max}$	threshold voltage	0.92				V
$R_{0\max}$	slope resistance *	10.5				m Ω

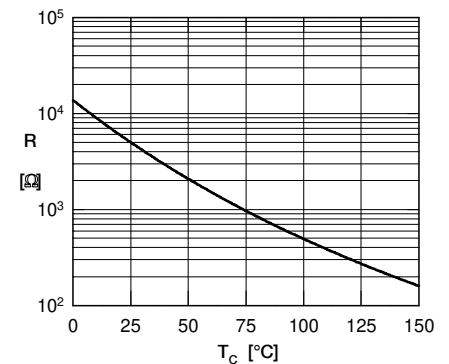



Outlines SMPD

A (8 : 1)

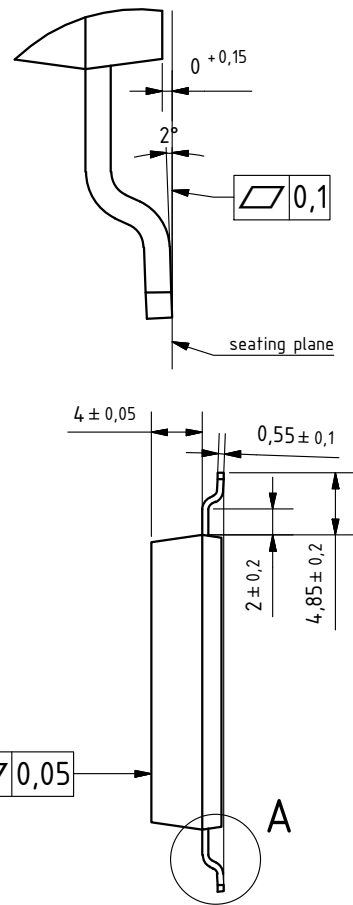
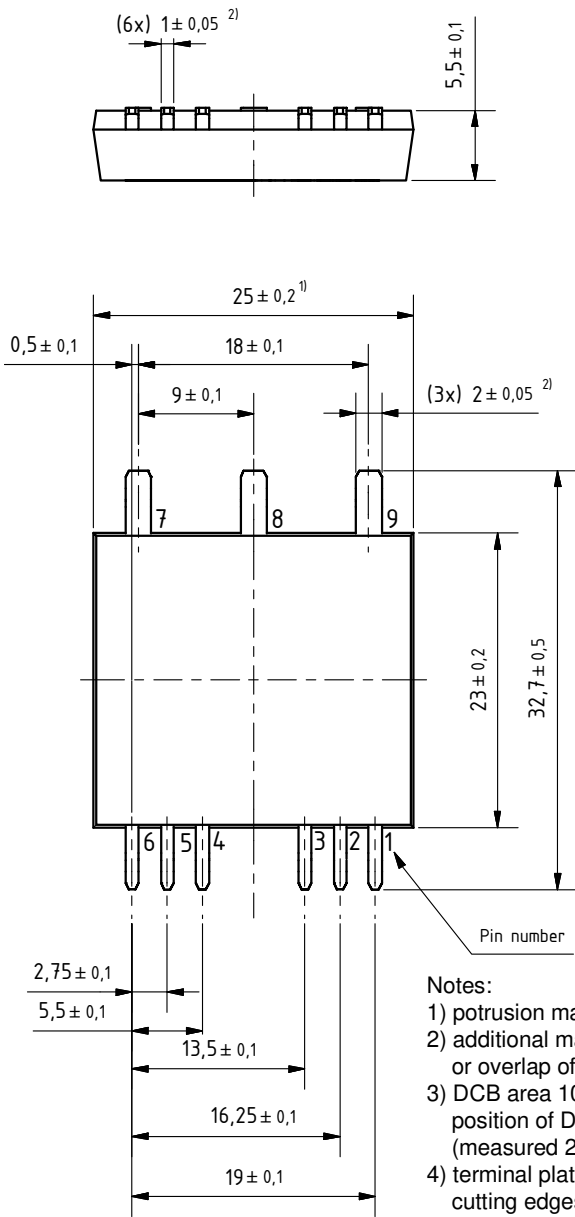

Notes:

- 1) protusion may add 0.2 mm max. on each side
- 2) additional max. 0.05 mm per side by punching misalignment or overlap of dam bar or bending compression
- 3) DCB area 10 to 50 μm convex; position of DCB area in relation to plastic rim: $\pm 25 \mu\text{m}$ (measured 2 mm from Cu rim)
- 4) terminal plating: 0.2 - 1 μm Ni + 10 - 25 μm Sn (gal v.) cutting edges may be partially free of plating

