



### Description

Thyristor AC controller module for mains frequency (50Hz/60Hz), utilizing two SCR dies in anti-parallel configuration for applications such as heating.

Robust SOT227B package with isolation voltage 2500V minimum

### Features & Benefits

- Compact and robust SOT227B package
- High current handling capability,  $I_{T(RMS)}=90A$
- Glass – passivated junctions
- Surge capability up to 950 A

### Applications

High power electrical tankless water heater

### Agency Approval

Agency	Agency File Number
	E71639

### Main Features

Symbol	Value	Unit
$I_{T(RMS)}$	90	A
$V_{DRM}/V_{RRM}$	600	V
$I_{GT}$	50	mA

### Schematic Symbol

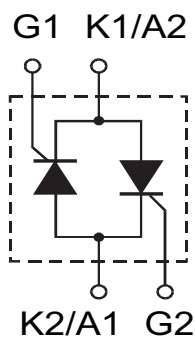

### Absolute Maximum Ratings

Symbol	Parameter	Test Conditions	Value	Unit
$I_{T(RMS)}$	On-State RMS Current - 360° as module	$T_C = 92^\circ\text{C}$	90	A
	On-State RMS Current - 180° as single SCR		65	
$I_{T(AV)}$	Average On-State Current - 360° as module	$T_C = 92^\circ\text{C}$	64	A
	Average On-State Current - 180° as single SCR		41	
$I_{TSM}$	Peak Non-Repetitive Surge Current, single cycle 60Hz		950	A
$I^2t$	$I^2t$ Value for fusing	$t_p = 8.3\text{ms}$	3745	$\text{A}^2\text{s}$
$di/dt$	Critical Rate-of-Rise of On-State Current	$I_G = 150\text{mA}$ , $f=60\text{Hz}$ , $T_J = 125^\circ\text{C}$	200	$\text{A}/\mu\text{s}$
$P_{GM}$	Peak Gate Power Dissipation	$T_J = 125^\circ\text{C}$ , $T_p=30\mu\text{s}$	10	W
		$T_J = 125^\circ\text{C}$ , $T_p=300\mu\text{s}$	5	
$P_{G(AV)}$	Average Gate Power Dissipation	$T_J = 125^\circ\text{C}$	1.0	W
$T_{stg}$	Storage Junction Temperature Range		-40 to 150	$^\circ\text{C}$
$T_J$	Operating junction Temperature Range		-40 to 125	$^\circ\text{C}$

### Electrical Characteristics ( $T_J = 25^\circ\text{C}$ , unless otherwise specified)

Symbol	Parameter	Test Conditions	Value		Unit
			min.	max.	
$I_{GT}$	DC Gate Trigger Current	$V_D = 12\text{V}$ ; $R_L = 30\ \Omega$	5	50	mA
$V_{GT}$	DC Gate Trigger Voltage			1.6	V
$I_H$	Holding Current	$I_T=400\text{mA}$ (initial)		80	mA
$dv/dt$	Critical Rate-of-Rise of Off-State Voltage	$T_J = 125^\circ\text{C}$ , $V_D = V_{DRM}/V_{RRM}$ , Exponential Waveform, Gate Open	500		$\text{V}/\mu\text{s}$
$t_q$	Turn-Off Time	$I_T=2\text{A}$ , $T_p=50\mu\text{s}$ , $dv/dt=5\text{V}/\mu\text{s}$ , $di/dt=-30\text{A}/\mu\text{s}$		35	$\mu\text{s}$
$t_{gt}$	Turn-On Time	$I_G = 150\text{mA}$ , $PW = 15\ \mu\text{s}$ , $I_T = 130\text{A(pk)}$		3	$\mu\text{s}$

### Static Characteristics

Symbol	Parameter	Test Conditions	Value	Unit	
$V_{TM}$	Peak On-State Voltage	$I_T = 130\ \text{A Peak}$ , $T_p=380\mu\text{s}$	MAX.	1.8	V
$I_{DRM}$ $I_{RRM}$	$V_D = V_{DRM}/V_{RRM}$	$T_J = 25^\circ\text{C}$	MAX.	20	$\mu\text{A}$
		$T_J = 125^\circ\text{C}$		3000	$\mu\text{A}$

### Thermal Resistances

Symbol	Parameter	Value	Unit
$R_{\theta(J-C)}$	Thermal Resistance, Junction to Case	0.3	$^\circ\text{C}/\text{W}$

**Figure 1: Normalized DC Gate Trigger Current vs. Junction Temperature**

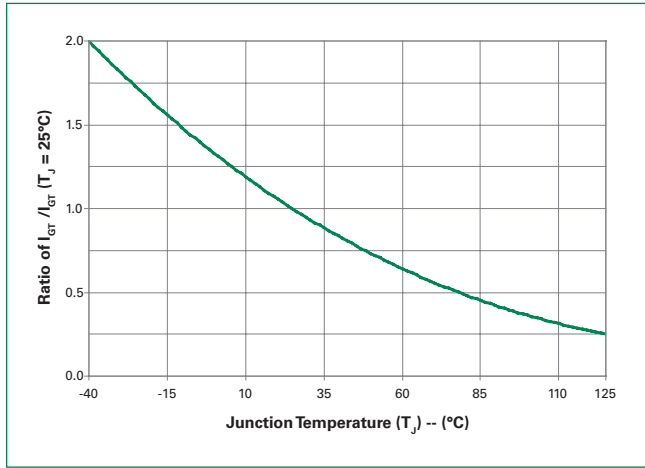

**Figure 2: Normalized DC Gate Trigger Voltage vs. Junction Temperature**

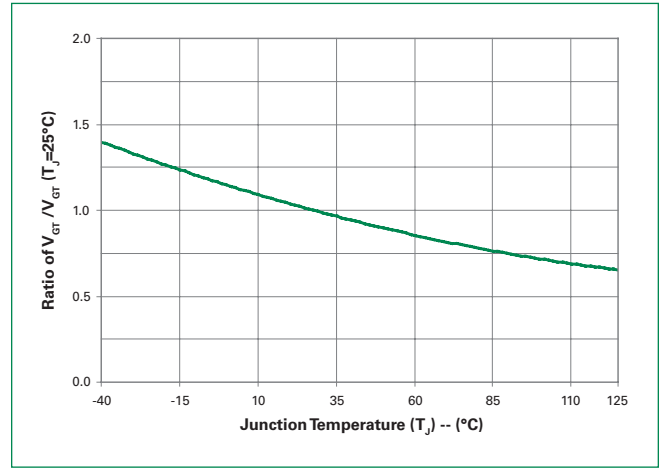

**Figure 3: Normalized DC Holding Current vs. Junction Temperature**

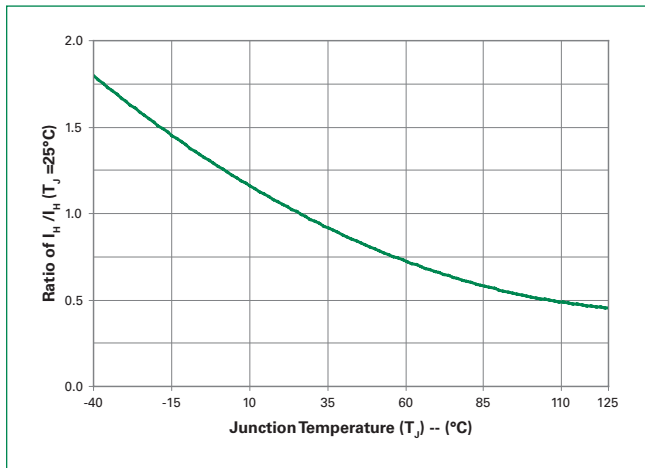

**Figure 4: On-State Current vs. On-State Voltage (Typical, per SCR)**

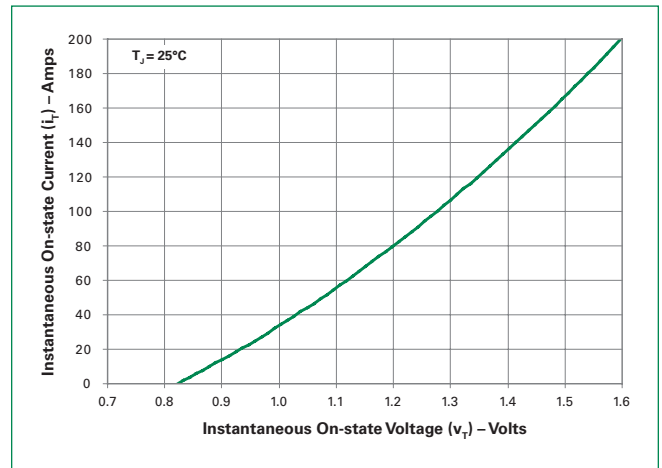

**Figure 5: Power Dissipation (Typical) vs. RMS On-State Current per SCR**

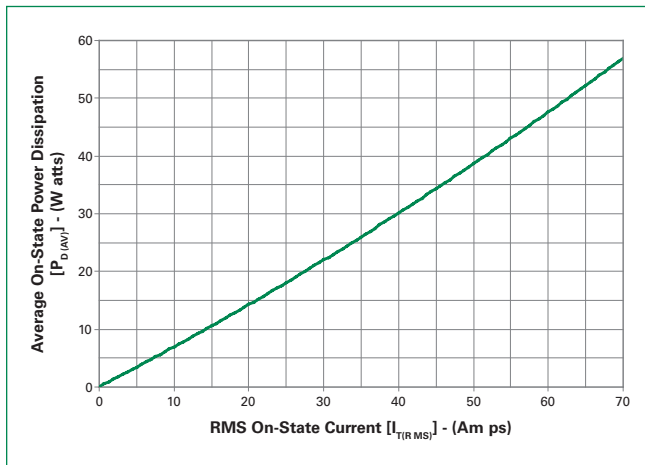

**Figure 6: Maximum Allowable Case Temperature vs. RMS On-State Current per module**

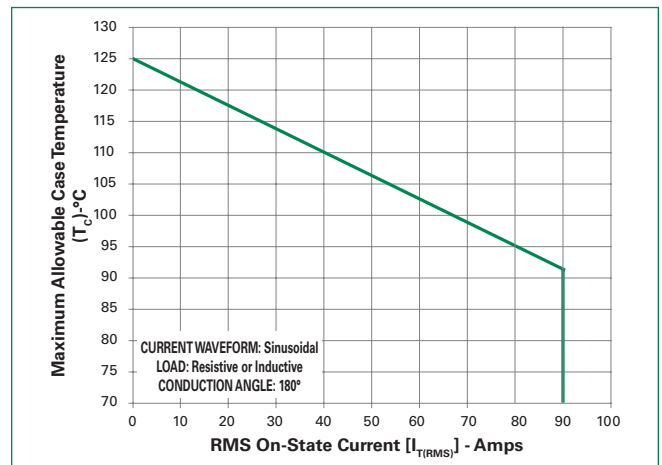

**Figure 7: Maximum Allowable Case Temperature vs. Average On-State Current per module**

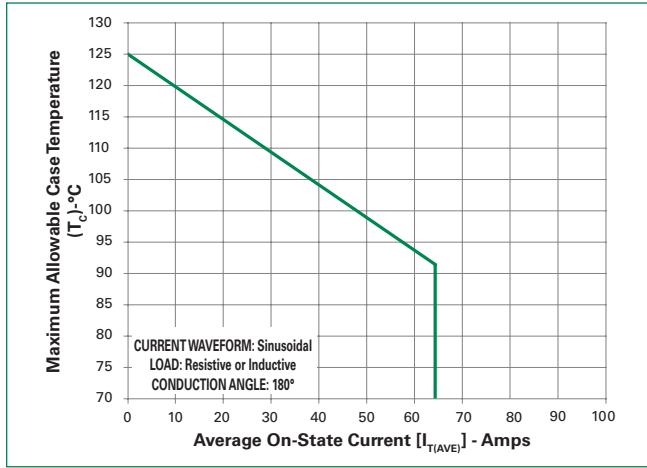

**Figure 7: Surge Peak On-State Current vs. Number of Cycles**

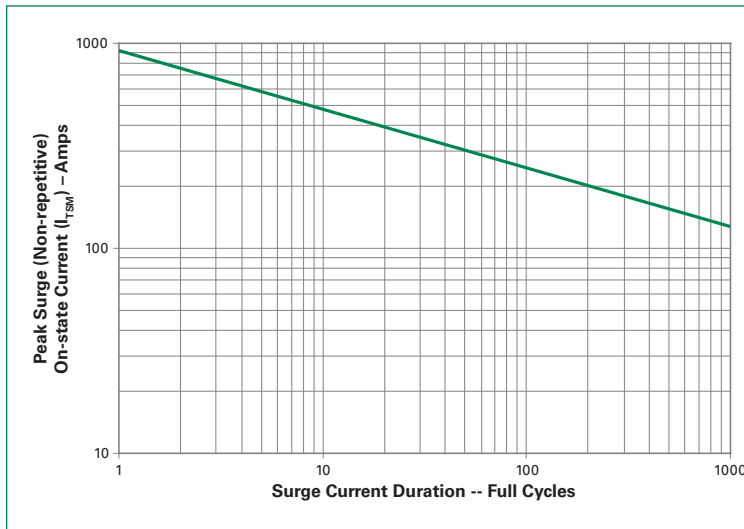

SUPPLY FREQUENCY: 60 Hz Sinusoidal  
 LOAD: Resistive  
 RMS On-State Current [ $I_{T(RMS)}$ ]: Maximum Rated Value at Specified Case Temperature

- Notes:
1. Gate control may be lost during and immediately following surge current interval.
  2. Overload may not be repeated until junction temperature has returned to steady-state rated value.

**Physical Specifications**

<b>Terminal Finish</b>	100% Nickel Plated
<b>Body</b>	UL recognized epoxy meeting flammability classification 94V-0
<b>Lead Material</b>	Copper Alloy

**Design Considerations**

Careful selection of the correct device for the application's operating parameters and environment will go a long way toward extending the operating life of the Thyristor. Good design practice should limit the maximum continuous current through the main terminals to 75% of the device rating. Other ways to ensure long life for a power discrete semiconductor are proper heat sinking and selection of voltage ratings for worst case conditions. Overheating, overvoltage (including dv/dt), and surge currents are the main killers of semiconductors. Correct mounting, soldering, and forming of the leads also help protect against component damage.

**Environmental Specifications**

Test	Specifications and Conditions
<b>AC Blocking</b>	MIL-STD-750, M-1040, Cond A Applied Peak AC voltage @ 125°C for 1008 hours
<b>Intermittent Operational Life</b>	MIL-STD-750, Method 1037, 15000cycles, $\Delta T_J \geq 100^\circ\text{C}$
<b>Temperature/Humidity</b>	EIA / JEDEC, JESD22-A101 504 hours; 160V - DC: 85°C; 85% rel humidity
<b>High Temp Storage</b>	MIL-STD-750, M-1031, 1008 hours; 150°C
<b>Low-Temp Storage</b>	1008 hours; -40°C
<b>Temperature Cycling</b>	MIL-STD-750, M-1051, 20 cycles; -25°C to +125°C; 15-min dwell-time

**Dimensions**

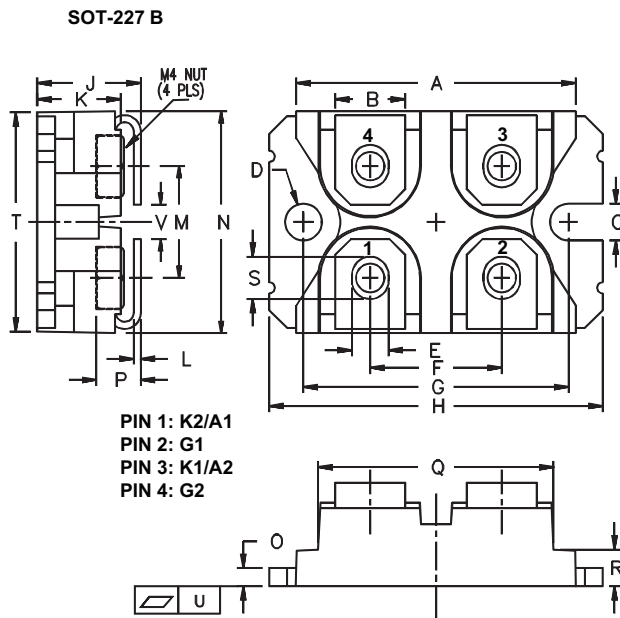

Note: M4x7.5MM screw, 4 screws per unit.

Dimension	Inches		Millimeters	
	Min	Max	Min	Max
A	1.240	1.256	31.50	31.90
B	0.307	0.323	7.80	8.20
C	0.161	0.169	4.09	4.29
D	0.161	0.169	4.09	4.29
E	0.161	0.169	4.09	4.29
F	0.587	0.595	14.91	15.11
G	1.186	1.193	30.12	30.30
H	1.489	1.505	37.80	38.20
J	0.460	0.481	11.68	12.22
K	0.351	0.378	8.92	9.60
L	0.030	0.033	0.76	0.84
M	0.497	0.507	12.62	12.88
N	0.990	1.001	25.15	25.42
O	0.078	0.084	1.98	2.13
P	0.193	0.232	4.90	5.89
Q	1.045	1.059	26.54	26.90
R	0.155	0.174	3.94	4.42
S	0.186	0.191	4.72	4.85
T	0.968	0.987	24.50	25.07
U	0	0.005	0	0.127
V	0.130	0.180	3.30	4.57

**Packing Options**

Part Number	Weight	Packing Mode	Base Quantity
MS0690J-DL1TE	30g	Tube	160

**Part Numbering System**

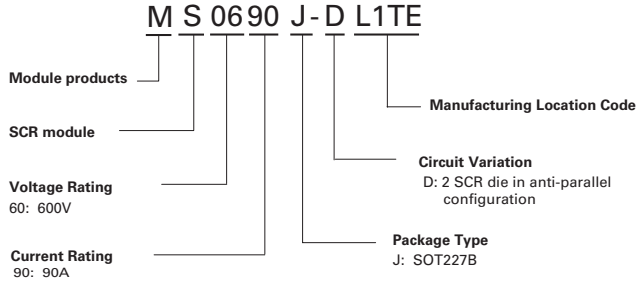

**Part Marking System**

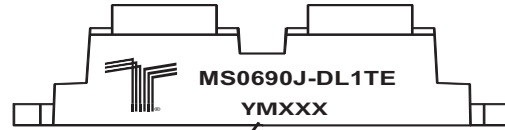

**Date Code Marking**  
 Y: Year Code  
 M: Month Code  
 XXX: Lot Trace Code