

LSIC1MO170T0750
1700 V, 750 mOhm N-Channel SiC MOSFET

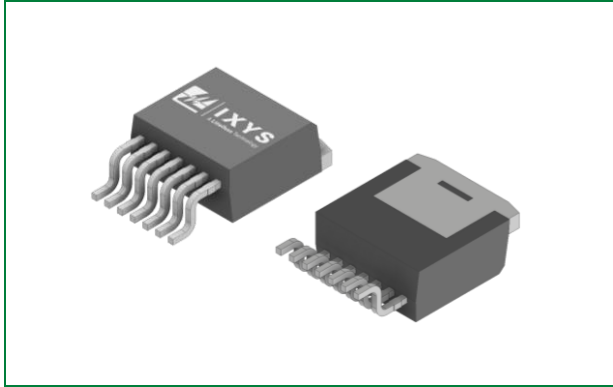

Agency Approvals and Environmental

Environmental Approvals



Pinout Diagram

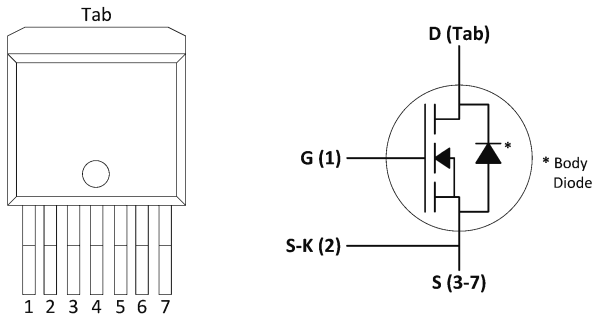

Product Summary

Characteristic	Value	Unit
V_{DS}	1700	V
Typical $R_{DS(ON)}$	750	mΩ
I_D ($T_C \leq 100\text{ }^\circ\text{C}$)	4.5	A

Features

- Optimized for high-frequency, high-efficiency applications
- Extremely low gate charge and output capacitance
- Low gate resistance for high-frequency switching
- Normally-off operations at all temperatures
- Optimized package with separate driver source pin and enhanced creepage
- RoHS compliant, lead-free, and halogen-free
- MSL 1 Rated

Applications

- Auxiliary Power Supplies
 - PV Inverters
 - UPS and Battery Chargers
 - Motor Drives
 - xEV Chargers
 - Industrial DC/DC and Inverters
- High-frequency Switch Mode Power Supplies

1. Maximum Ratings.....3

2. Thermal Characteristics3

3. Electrical Characteristics3

 3.1. Static Characteristics ($T_J = 25\text{ }^\circ\text{C}$ unless otherwise specified)3

 3.2. Dynamic Characteristics ($T_J = 25\text{ }^\circ\text{C}$ unless otherwise specified)4

4. Reverse Diode Characteristics ($T_J = 25\text{ }^\circ\text{C}$ unless otherwise specified)4

5. Figure Data5

6. Package Dimensions9

7. Part Numbering and Marking.....9

8. Packing Options9

9. Packing Specifications10

 9.1. Tube Option10

 9.2. Tape and Reel Option11

1. Maximum Ratings

Characteristic	Symbol	Conditions	Value	Unit
Drain-Source Voltage	V_{DS}	$V_{GS} = 0\text{ V}$	1700	V
Continuous Drain Current	I_D	$V_{GS} = 20\text{ V}, T_C = 25\text{ °C}$	6.4	A
		$V_{GS} = 20\text{ V}, T_C = 100\text{ °C}$	4.5	
Pulsed Drain Current ¹	$I_{D(pulse)}$	$T_C = 25\text{ °C}$	11	A
Power Dissipation	P_D	$T_C = 25\text{ °C}, T_J = 175\text{ °C}$	65	W
Gate-Source Voltage	$V_{GS,MAX}$	Absolute maximum values – Steady state	-6 to +22	V
	$V_{GS,OP,TR}$ ²	Transient, $t_{transient} < 300\text{ nsec}$	-10 to +25	
	$V_{GS,OP}$ ³	Recommended DC operating values	-5 to +20	
Operating Junction Temperature	T_J	-	-55 to +175	°C
Storage Temperature	T_{STG}	-	-55 to +150	°C
Lead Temperature for Soldering (MSL1 Rated)	T_{SOLD}	-	260	°C
ESD Sensitivity Rating	HBM ESD	Maximum Withstand Voltage	250	V
	CDM ESD		1000	

Footnote 1: Pulse width limited by $T_{J,MAX}$

Footnote 2: See Figure 21 for further information

Footnote 3: MOSFET can operate with $V_{GS(OFF)} = 0\text{ V}$ – dependent upon PCB layout. $V_{GS(OFF)} = -5\text{ V}$ provides added noise margin and faster turn-off speed

2. Thermal Characteristics

Characteristic	Symbol	Value	Unit
Maximum Thermal Resistance, junction-to-case	$R_{th,JC,MAX}$	2.3	°C/W
Maximum Thermal Resistance, junction-to-ambient	$R_{th,JA,MAX}$	40	°C/W

3. Electrical Characteristics

3.1. Static Characteristics ($T_J = 25\text{ °C}$ unless otherwise specified)

Characteristic	Symbol	Conditions	Value			Unit
			Min	Typ	Max	
Drain-Source Breakdown Voltage	$V_{(BR)DSS}$	$V_{GS} = 0\text{ V}, I_D = 100\text{ }\mu\text{A}$	1700	-	-	V
Zero Gate Voltage Drain Current	I_{DSS}	$V_{DS} = 1700\text{ V}, V_{GS} = 0\text{ V}$	-	<1	10	μA
		$V_{DS} = 1700\text{ V}, V_{GS} = 0\text{ V}, T_J = 175\text{ °C}$	-	<1	-	
Gate Leakage Current	$I_{GSS,F}$	$V_{GS} = 22\text{ V}, V_{DS} = 0\text{ V}$	-	-	100	nA
	$I_{GSS,R}$	$V_{GS} = -6\text{ V}, V_{DS} = 0\text{ V}$	-	-	100	
Drain-Source On-State Resistance	$R_{DS(ON)}$	$I_D = 2\text{ A}, V_{GS} = 20\text{ V}$	-	750	1000	m Ω
		$I_D = 2\text{ A}, V_{GS} = 20\text{ V}, T_J = 175\text{ °C}$	-	1550	-	
Gate Threshold Voltage	$V_{GS(TH)}$	$V_{DS} = V_{GS}, I_D = 1\text{ mA}$	1.8	2.8	4.0	V
		$V_{DS} = V_{GS}, I_D = 1\text{ mA}, T_J = 175\text{ °C}$	-	1.9	-	
Gate Resistance	R_G	Resonance method, Drain-Source shorted ¹	-	29	-	Ω

Footnote 1: For a description of the resonance method for measuring R_G , refer to the JEDEC Standard JESD24-11 test method

3.2. Dynamic Characteristics (T_J = 25 °C unless otherwise specified)

Characteristic	Symbol	Conditions	Value			Unit
			Min	Typ	Max	
Turn-On Switching Energy	E _{ON}	V _{DD} = 1200 V, I _D = 2 A, V _{GS} = -5 / +20 V, R _{G,ext} = 2 Ω, L = 1.4 mH, FWD = LSIC1MO170T0750	-	80	-	μJ
Turn-Off Switching Energy	E _{OFF}		-	43	-	
Total Per-Cycle Switching Energy	E _{TS}		-	123	-	
Input Capacitance	C _{ISS}	V _{DD} = 1000 V, V _{GS} = 0 V, f = 1 MHz, V _{AC} = 25 mV	-	200	-	pF
Output Capacitance	C _{OSS}		-	11.5	-	
Reverse Transfer Capacitance	C _{RSS}		-	1.7	-	
COSS Stored Energy	E _{OSS}		-	5.7	-	
Total Gate Charge	Q _g	V _{DD} = 1200 V, I _D = 2 A, V _{GS} = -5 / +20 V	-	11	-	nC
Gate-Source Charge	Q _{gs}		-	4	-	
Gate-Drain Charge	Q _{gd}		-	5	-	
Turn-On Delay Time	t _{d(on)}	V _{DD} = 1200 V, V _{GS} = -5 / +20 V, I _D = 2 A, R _{G,ext} = 2 Ω, R _L = 600 Ω, Timing relative to V _{DS}	-	8	-	ns
Rise Time	t _r		-	15	-	
Turn-Off Delay Time	t _{d(off)}		-	27	-	
Fall Time	t _f		-	173	-	

4. Reverse Diode Characteristics (T_J = 25 °C unless otherwise specified)

Characteristic	Symbol	Conditions	Value			Unit
			Min	Typ	Max	
Diode Forward Voltage	V _{SD}	I _S = 1 A, V _{GS} = -5 V	-	4.2	-	V
		I _S = 1 A, V _{GS} = -5 V, T _J = 175 °C	-	3.6	-	
Continuous Diode Forward Current	I _S	V _{GS} = -5 V, T _C = 25 °C	-	-	9	A
Peak Diode Forward Current ¹	I _{SP}		-	-	11	

Footnote 1: Pulse width limited by T_{J,MAX}

5. Figure Data

Figure 1. Maximum Power Dissipation ($T_J = 175\text{ }^\circ\text{C}$)

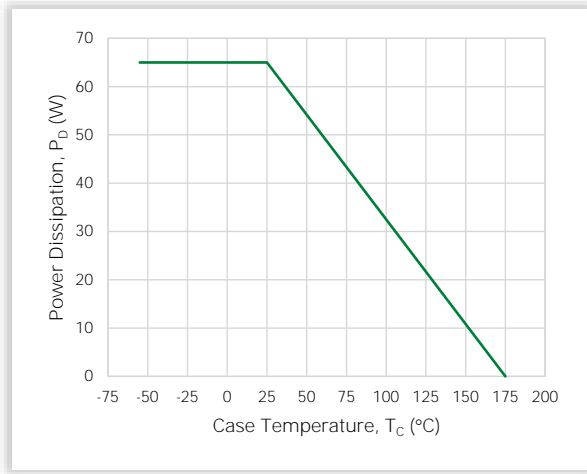

Figure 2. Typical Transfer Characteristics

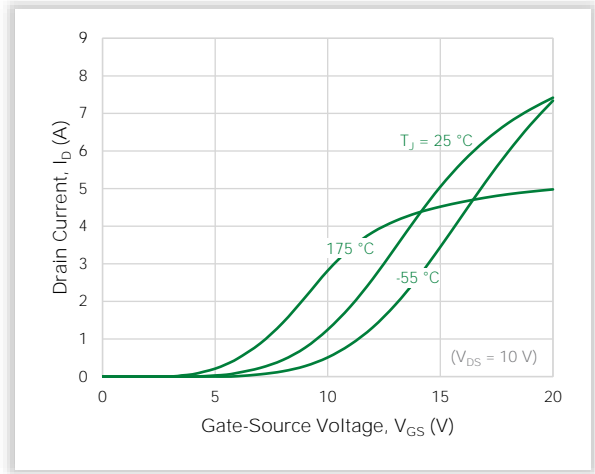

Figure 3. Typical Output Characteristics ($T_J = 25\text{ }^\circ\text{C}$)

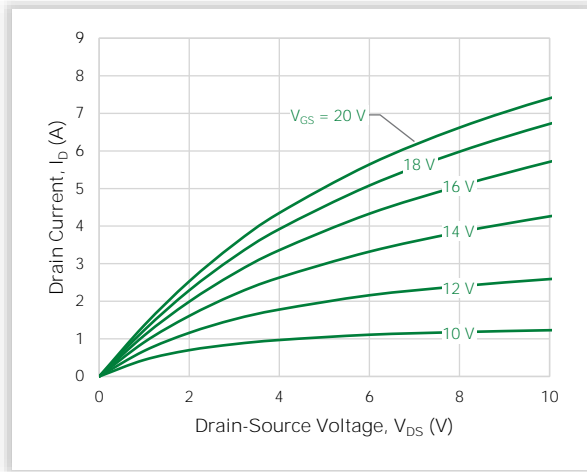

Figure 4. Typical Output Characteristics ($T_J = 175\text{ }^\circ\text{C}$)

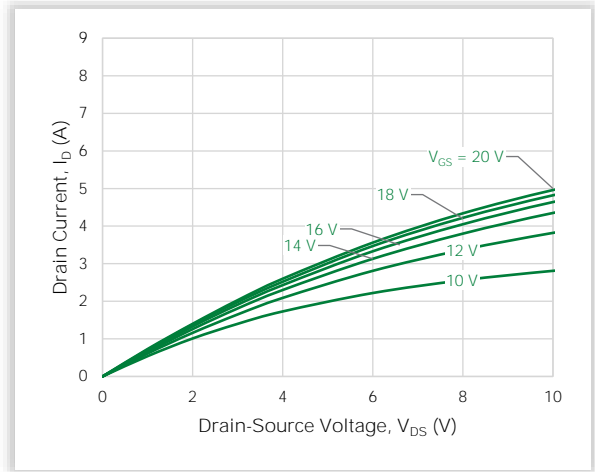

Figure 5. Typical Output Characteristics ($T_J = -55\text{ }^\circ\text{C}$)

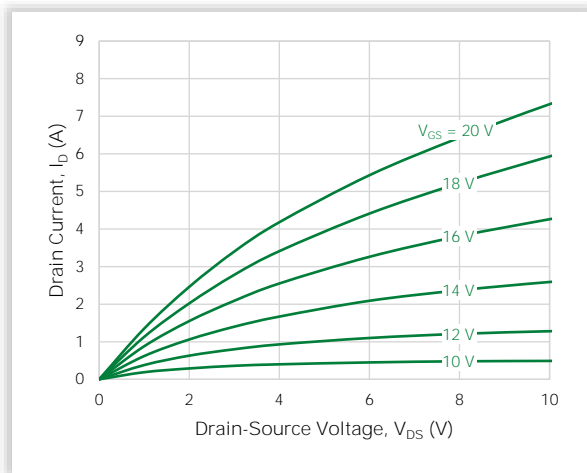

Figure 6. Typical Reverse Conduction Characteristics ($T_J = 25\text{ }^\circ\text{C}$)

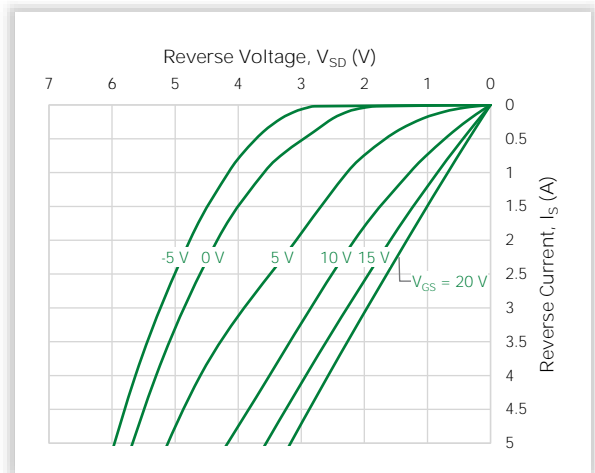

Figure 7. Typical Reverse Conduction Characteristics ($T_J = 175\text{ }^\circ\text{C}$)

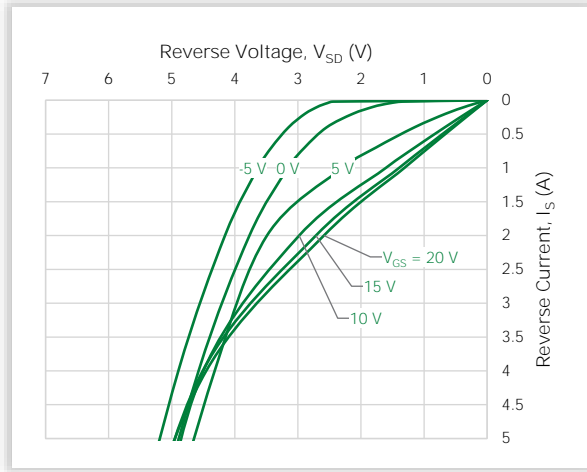

Figure 8. Typical Reverse Conduction Characteristics ($T_J = -55\text{ }^\circ\text{C}$)

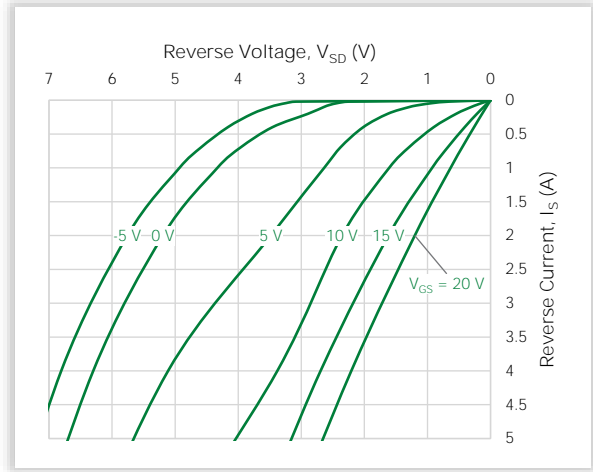

Figure 9. Typical Transient Thermal Impedance

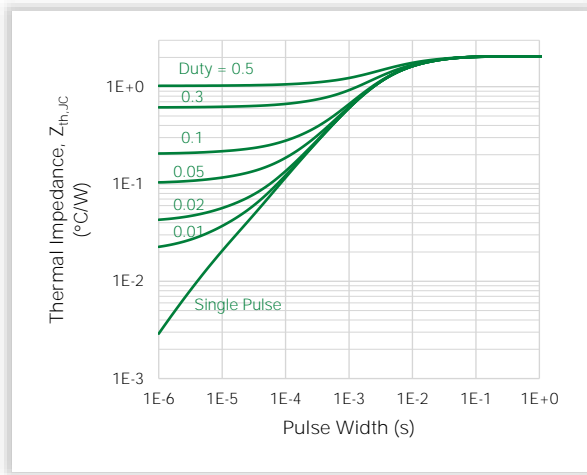

Figure 10. Maximum Safe Operating Area ($T_C = 25\text{ }^\circ\text{C}$)

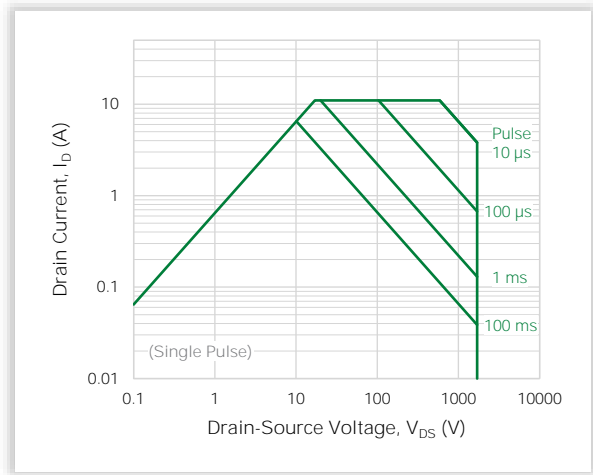

Figure 11. On-resistance vs. Drain Current

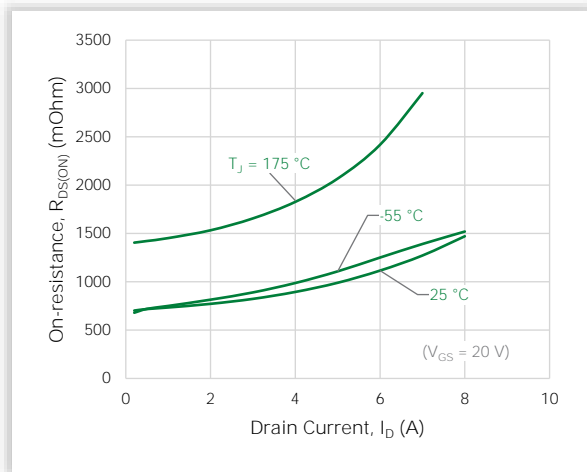

Figure 12. Normalized On-resistance vs. Junction Temperature

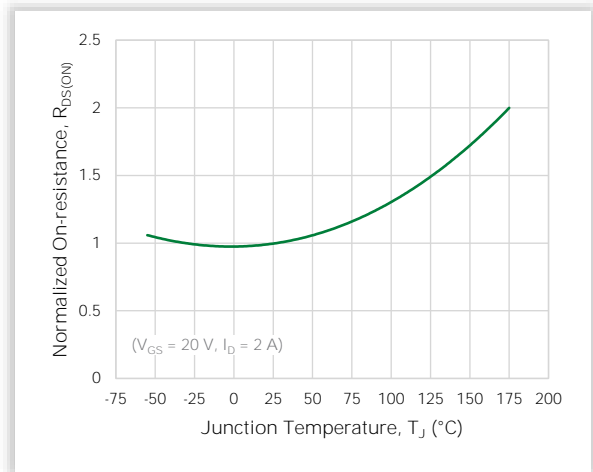

Figure 13. Typical On-resistance vs. Junction Temperature

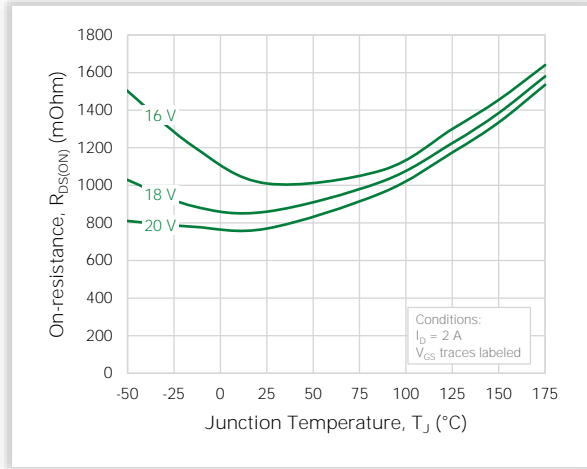

Figure 14. Typical Threshold Voltage

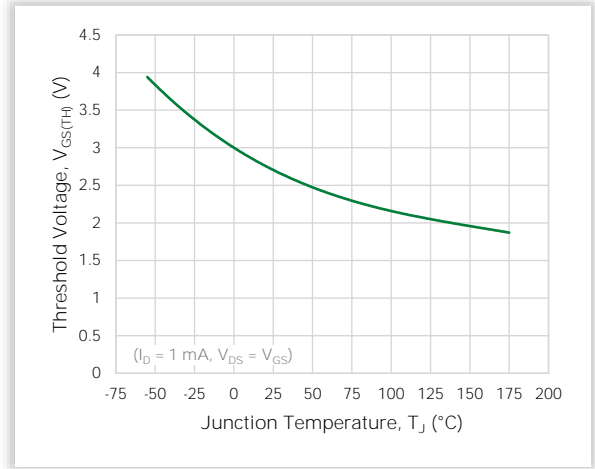

Figure 15. Typical Junction Capacitances up to 1000 V

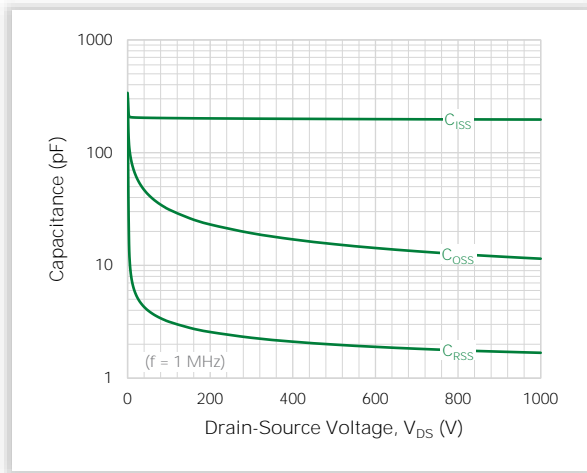
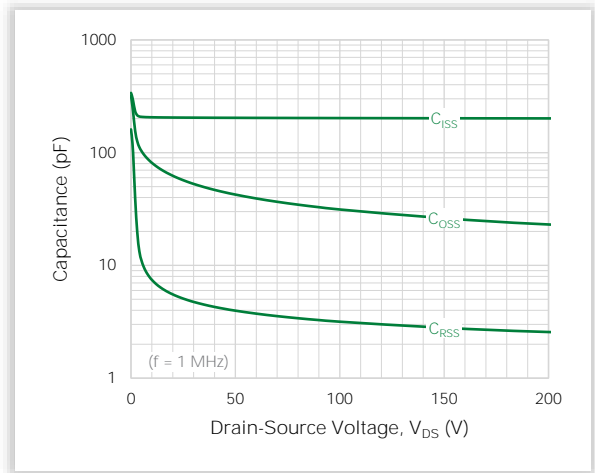

Figure 16. Typical Junction Capacitances up to 200 V



Capacitances up to 200 V

Figure 17. Typical C_{oss} Stored Energy E_{oss}

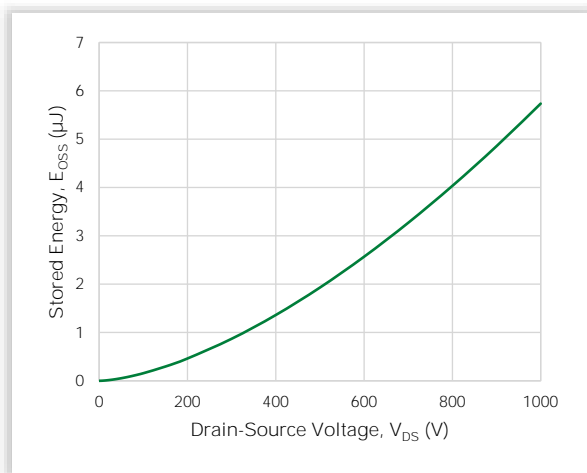

Figure 18. Typical Gate Charge

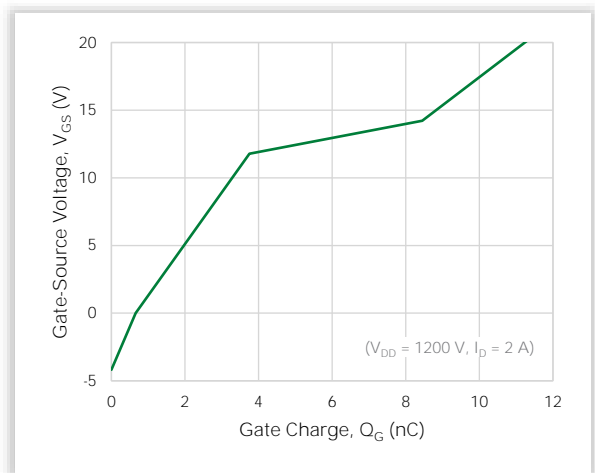

Figure 19. Typical Switching Energy vs. Drain Current

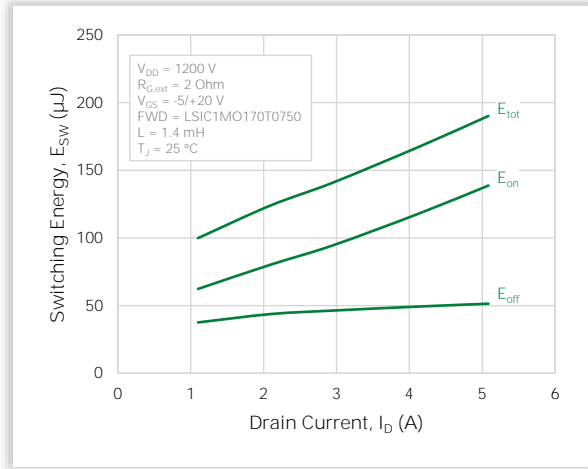

Figure 20. Typical Switching Energy vs. External Gate Resistance

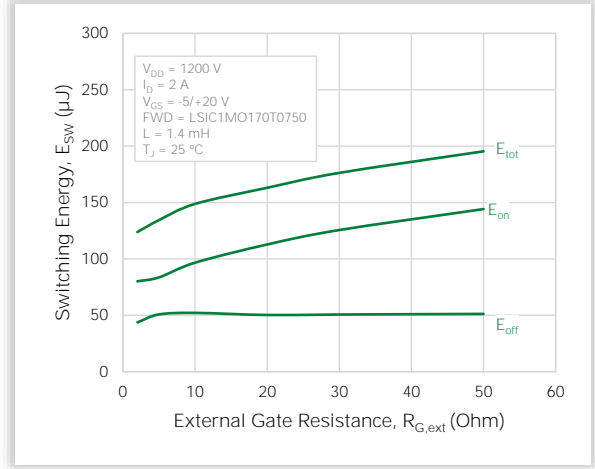
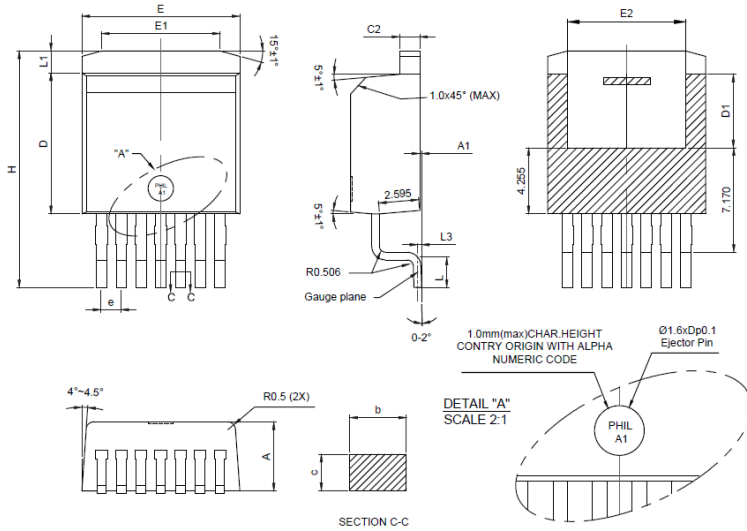

Figure 21. V_GS Waveform Definition



6. Package Dimensions



Symbol	Millimeters		
	Min	Nom	Max
A	4.300	4.435	4.570
A1	0.000	0.125	0.250
b	0.500	0.600	0.700
c	0.330	0.490	0.650
C2	1.170	1.285	1.400
D	9.025	9.075	9.125
D1	4.656	4.733	4.810
E	10.130	10.180	10.230
E1	6.500	7.550	8.600
E2	6.778	7.223	7.665
e	1.220	1.270	1.320
H	15.043	16.178	17.121
L	2.324	2.512	2.700
L1	1.160	1.418	1.676
L3		0.254	

Recommended Solder Pad Layout:

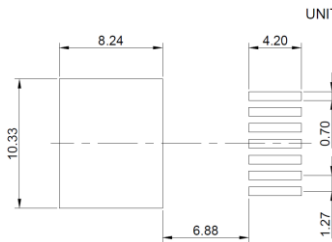

Notes:

1. Dimensions D & E do not include mold flash. Mold flash shall not exceed 0.127 mm per side. These dimensions are measured at the outermost extreme of the plastic body.
2. Package is designed for high voltage and does not conform to JEDEC std.
3. Top package/marketing surface finish: 16-18 VDI.

7. Part Numbering and Marking

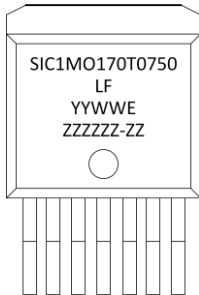

- SiC = SiC
- 1 = Gen 1
- MO = MOSFET
- 170 = Voltage Rating (1700 V)
- T = TO-263-7L
- 0750 = $R_{DS(ON)}$ (750 mOhm)
- YY = Year
- WW = Week
- E = Special Code
- ZZZZZZ-ZZ = Lot Number

8. Packing Options

Part Number	Marking	Packing Mode	M.O.Q.
LSIC1MO170T0750-TU	SIC1MO170T0750	Tube (50 pcs)	400
LSIC1MO170T0750-TR	SIC1MO170T0750	Tape & Reel (800 pcs/reel)	800

9. Packing Specifications

9.1. Tube Option

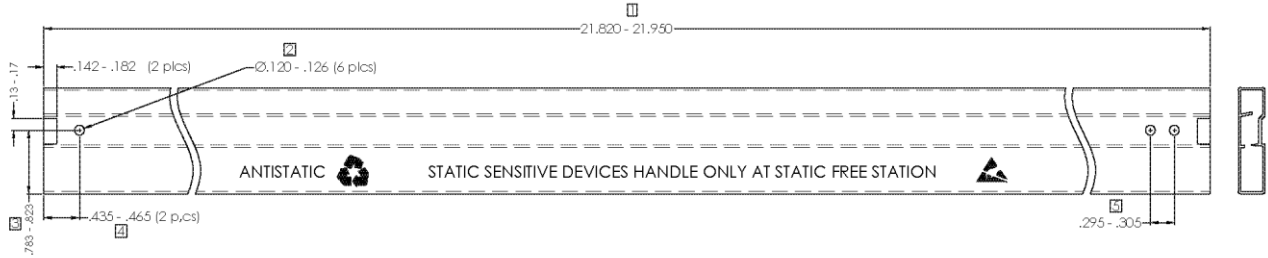

Notes:

- 1. Clear PVC material with anti-static coating
- 2. Radius is a maximum of 0.5 unless otherwise specified
- 3. Critical areas are labeled in box
- 4. All pin plug holes are considered critical dimension
- 5. Material thickness is 0.75 ±0.10
- 6. Tolerance unless otherwise specified is : Decimal ±0.05 Angle ±1°
- 7. Dimensions are in inches

