

LSIC2SD065D16A 650 V, 16 A SiC Schottky Barrier Diode



Description

This series of silicon carbide (SiC) Schottky diodes has negligible reverse recovery current, high surge capability, and a maximum operating junction temperature of 175 °C. These diodes series are ideal for applications where improvements in efficiency, reliability, and thermal management are desired.

Features

- AEC-Q101 qualified
- Positive temperature coefficient for safe operation and ease of paralleling
- 175 °C maximum operating junction temperature
- Excellent surge capability
- Extremely fast, temperature-independent switching behavior
- Dramatically reduced switching losses compared to Si bipolar diodes

Circuit Diagram TO-263-2L

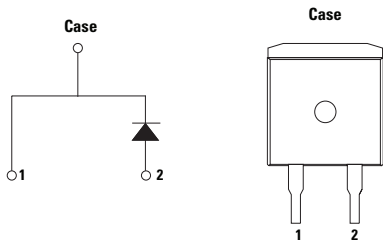

Applications

- Boost diodes in PFC or DC/DC stages
- Switch-mode power supplies
- Uninterruptible power supplies
- Solar inverters
- Industrial motor drives
- EV charging stations

Environmental

- Littelfuse "RoHS" logo = RoHS conform
- Littelfuse "HF" logo = **HF** Halogen Free
- Littelfuse "Pb-free" logo = Pb-free lead plating

Maximum Ratings

Characteristics	Symbol	Conditions	Value	Unit
Repetitive Peak Reverse Voltage	V_{RRM}	-	650	V
DC Blocking Voltage	V_R	$T_J = 25\text{ °C}$	650	V
Continuous Forward Current	I_F	$T_C = 25\text{ °C}$	38	A
		$T_C = 135\text{ °C}$	17.2	
		$T_C = 140\text{ °C}$	16	
Non-Repetitive Forward Surge Current	I_{FSM}	$T_C = 25\text{ °C}, T_P = 10\text{ ms}, \text{Half sine pulse}$	70	A
Power Dissipation	P_{Tot}	$T_C = 25\text{ °C}$	125	W
		$T_C = 110\text{ °C}$	54	
Operating Junction Temperature	T_J	-	-55 to 175	°C
Storage Temperature	T_{STG}	-	-55 to 150	°C
Soldering Temperature	T_{SOLD}	-	260	°C

Electrical Characteristics ($T_J = 25\text{ }^\circ\text{C}$ unless otherwise specified)

Characteristics	Symbol	Conditions	Value			Unit
			Min.	Typ.	Max.	
Forward Voltage	V_F	$I_F = 16\text{ A}, T_J = 25\text{ }^\circ\text{C}$	-	1.5	1.8	V
		$I_F = 16\text{ A}, T_J = 175\text{ }^\circ\text{C}$	-	1.85	-	
Reverse Current	I_R	$V_R = 650\text{ V}, T_J = 25\text{ }^\circ\text{C}$	-	<1	50	μA
		$V_R = 650\text{ V}, T_J = 175\text{ }^\circ\text{C}$	-	55	-	
Total Capacitance	C	$V_R = 1\text{ V}, f = 1\text{ MHz}$	-	730	-	pF
		$V_R = 200\text{ V}, f = 1\text{ MHz}$	-	92	-	
		$V_R = 400\text{ V}, f = 1\text{ MHz}$	-	66	-	
Total Capacitive Charge	Q_C	$V_R = 400\text{ V}, Q_C = \int_0^{V_R} C(V)dV$	-	48	-	nC

Thermal Characteristics

Characteristics	Symbol	Value	Unit
Thermal Resistance	R_{JC}	1.2	$^\circ\text{C}/\text{W}$

Figure 1: Typical Forward Characteristics

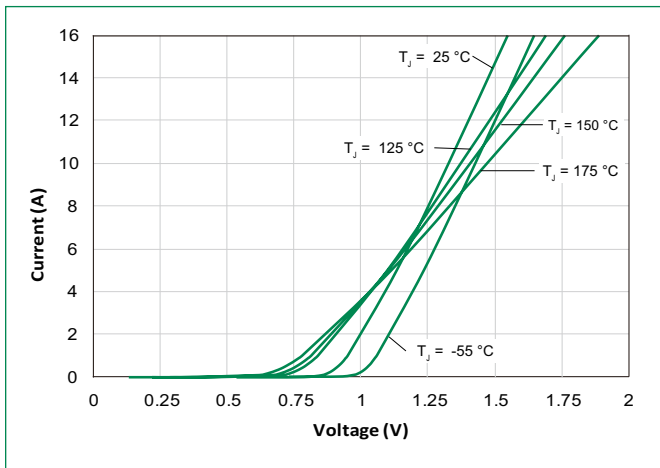

Figure 2: Typical Reverse Characteristics

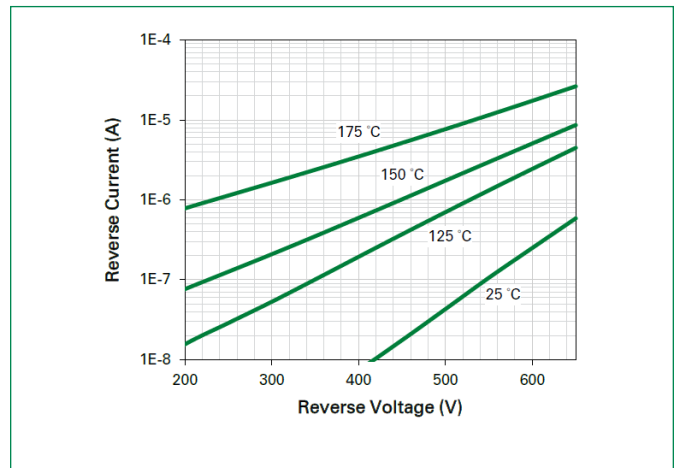

Figure 3: Power Derating

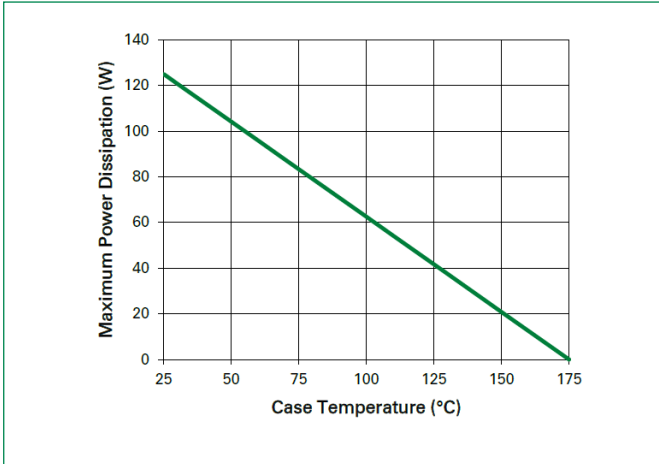

Figure 4: Current Derating

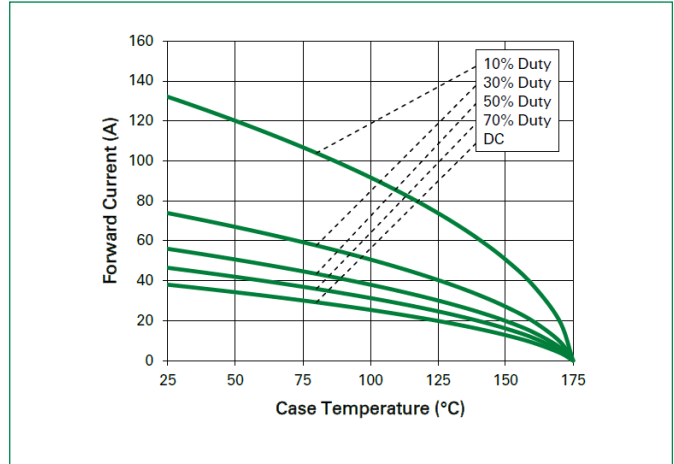

Figure 5: Capacitance vs. Reverse Voltage

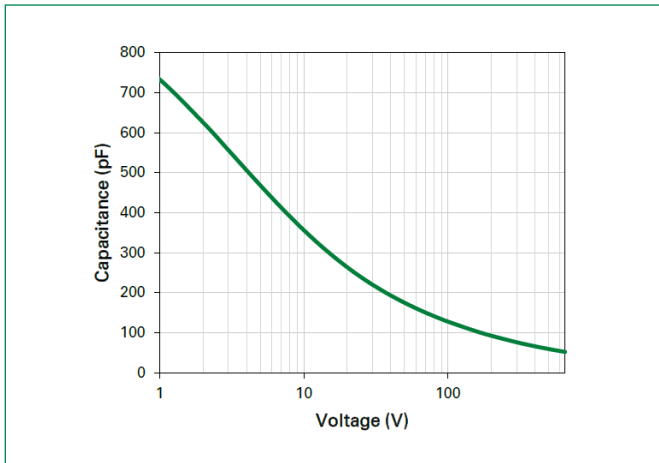

Figure 6: Capacitive Charge vs. Reverse Voltage

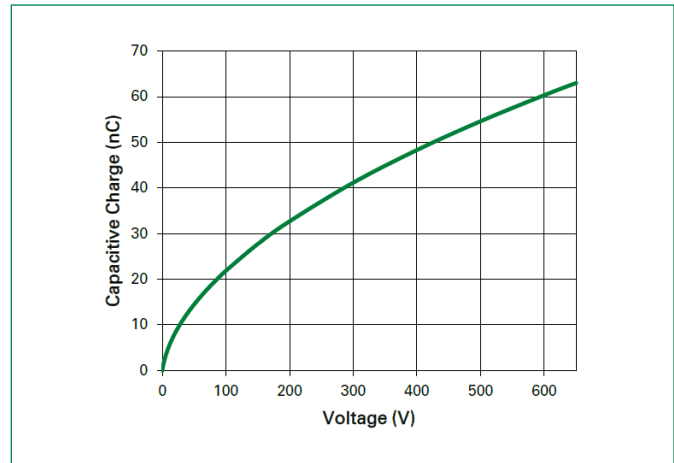

Figure 7: Stored Energy vs. Reverse Voltage

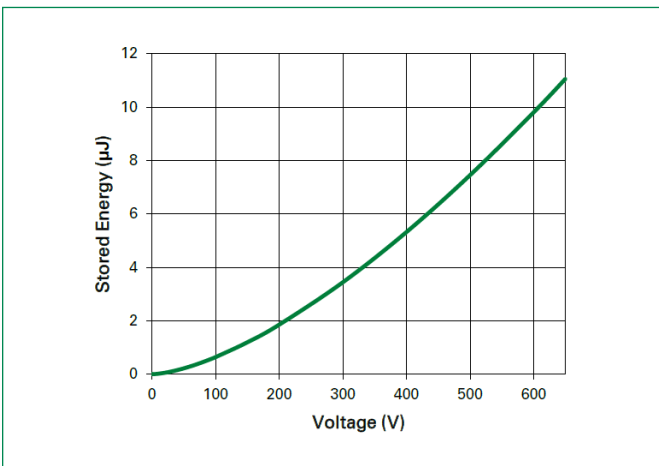
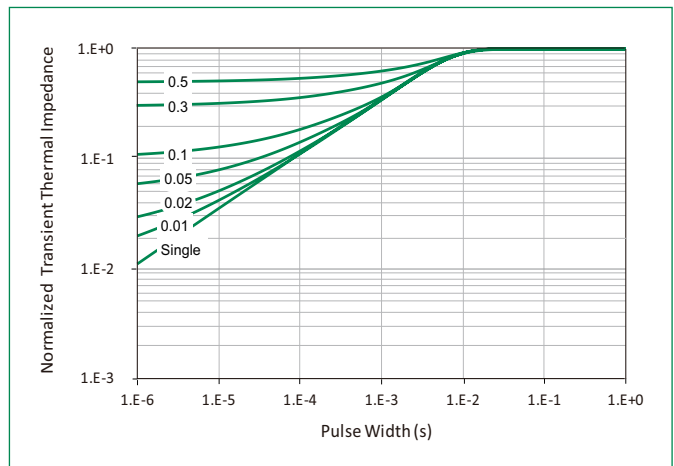
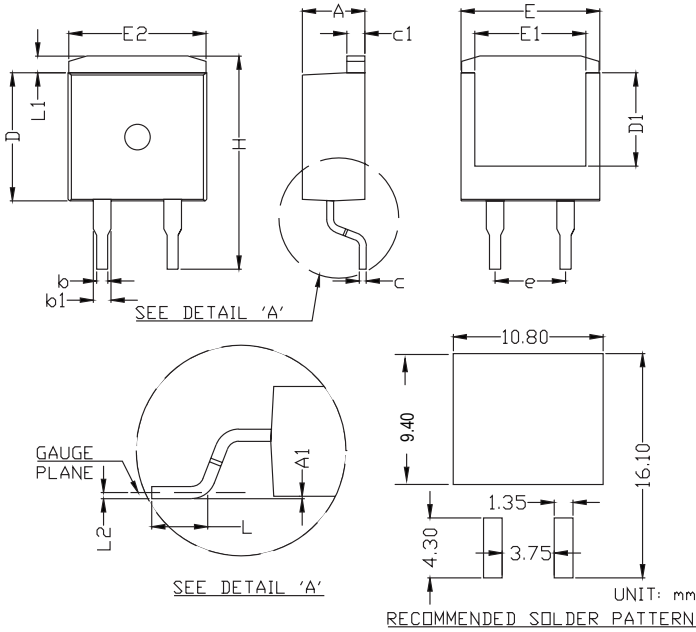

Figure 8: Transient Thermal Impedance



Dimensions-Package TO-263-2L



Symbol	Millimeters		
	Min	Nom	Max
A	4.30	4.50	4.70
A1	0.00	-	0.25
b	0.70	0.80	0.90
b1	1.17	1.27	1.37
c	0.46	0.50	0.60
c1	1.25	1.30	1.40
D	9.00	9.20	9.40
D1	6.50	6.70	6.90
E	9.80	10.00	10.20
E1	7.80	8.00	8.20
E2	9.70	9.90	10.10
e	5.08 BSC		
H	15.00	15.30	15.60
L	2.00	2.30	2.60
L1	1.00	1.20	1.40
L2	0.254 BSC		

Part Numbering and Marking System

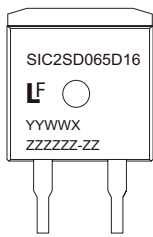

- SIC = SiC Diode
- 2 = Gen2
- SD = Schottky Diode
- 065 = Voltage Rating (650 V)
- D = TO-263 Package (2 Lead)
- 16 = Current Rating (16 A)
- YY = Year
- WW = Week
- X = Special Code
- ZZZZZ-ZZ = Lot Number

Packing Option

Part Number	Marking	Packing Mode	M.O.Q
LSIC2SD065D16A	SIC2SD065D16	Tape and Reel	800

