

### DST560S

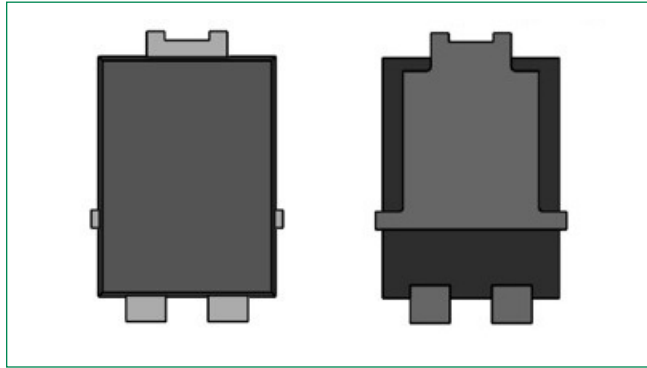

#### Pin out

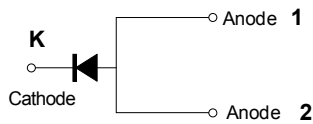

#### Description

Littelfuse DST series Ultra Low  $V_F$  Schottky Barrier Rectifier is designed to meet the general requirements of commercial and industry applications by providing high temperature, low leakage and lower  $V_F$  products.

It is suitable for high frequency switching mode power supply, free-wheeling diodes and polarity protection diodes.

#### Features

- Ultra low forward voltage drop
- High frequency operation
- MSL: Level 1 - unlimited
- High junction temperature capability
- Trench MOS Schottky technology
- Single die in TO-277B Package
- Pb-free E3 means 2nd level interconnect is Pb-free and the terminal finish material is tin(Sn) (IPC/ JEDEC J-STD-609A.01)

#### Applications

- Switching mode power supply
- DC/DC converters
- Free-Wheeling diodes
- Polarity Protection Diodes

#### Maximum Ratings

Parameters	Symbol	Test Conditions	Max	Unit
Peak Inverse Voltage	$V_{RWM}$	-	60	V
Average Forward Current	$I_{F(AV)}$	50% duty cycle @ $T_L = 125^\circ\text{C}$ rectangular wave form	5	A
Peak One Cycle Non-Repetitive Surge Current	$I_{FSM}$	8.3 ms, half Sine pulse	100	A

#### Electrical Characteristics

Parameters	Symbol	Test Conditions	Typ	Max	Unit
Forward Voltage Drop*	$V_{F1}$	@2.5A, Pulse, $T_J = 25^\circ\text{C}$	0.42	-	V
		@5A, Pulse, $T_J = 25^\circ\text{C}$	0.50	0.70	
	$V_{F2}$	@2.5A, Pulse, $T_J = 125^\circ\text{C}$	0.33	-	
		@5A, Pulse, $T_J = 125^\circ\text{C}$	0.44	0.60	
Reverse Current*	$I_{R1}$	@ $V_R = \text{rated } V_R, T_J = 25^\circ\text{C}$	0.01	0.7	mA
	$I_{R2}$	@ $V_R = \text{rated } V_R, T_J = 125^\circ\text{C}$	6.4	25	
Junction Capacitance	$C_T$	@ $V_R = 5\text{V}, T_C = 25^\circ\text{C}, f_{SIG} = 1\text{MHz}$	314	-	pF

\* Pulse Width < 300 $\mu\text{s}$ , Duty Cycle < 2%

**Thermal-Mechanical Specifications**

Parameters	Symbol	Test Conditions	Max	Unit
Junction Temperature	$T_J$		-55 to +150	°C
Storage Temperature	$T_{stg}$		-55 to +150	°C
Maximum Thermal Resistance Junction to Ambient	$R_{thJA}$	DC operation	75	°C/W
Maximum Thermal Resistance Junction to Lead	$R_{thJL}$		4	°C/W
Approximate Weight	wt		0.08	g
Case Style	TO-277B			

**Figure 1: Typical Forward Characteristics**

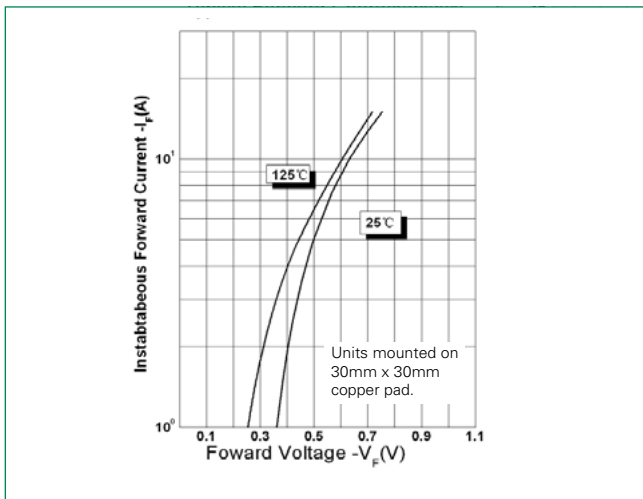

**Figure 2: Typical Reverse Characteristics**

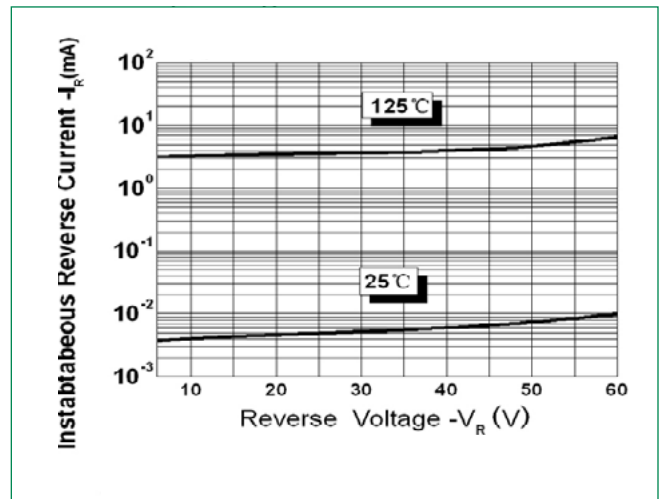

**Figure 3: Typical Junction Capacitance**

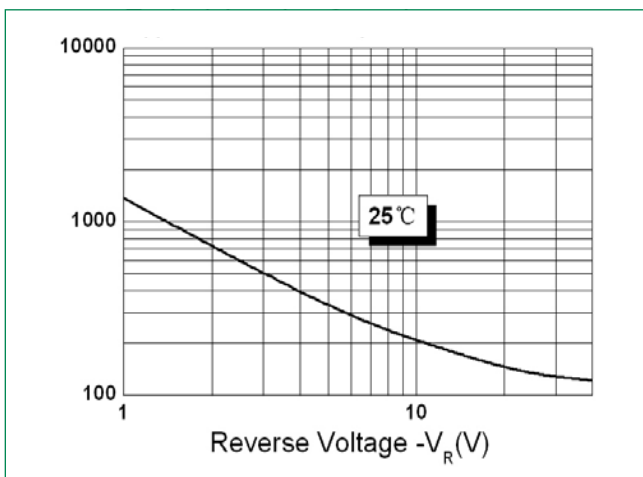

### Dimensions-TO-277B

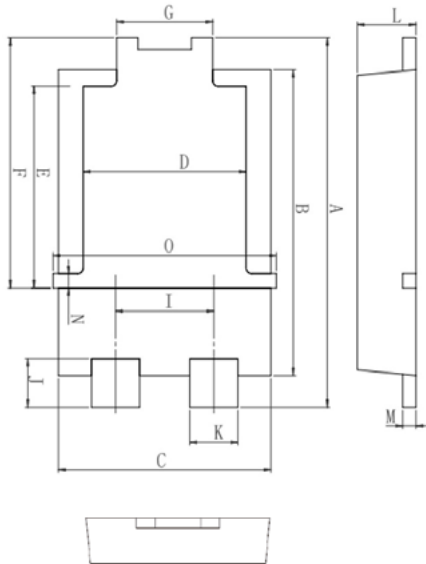

Symbol	Millimeters		
	Min	Typ	Max
A	6.30	6.50	6.70
B	5.28	5.38	5.48
C	3.88	3.98	4.08
D	2.90	3.05	3.20
E	3.40	3.55	3.70
F	4.20	4.40	4.60
G	1.70	1.80	1.90
I	1.74	1.84	1.94
J	0.65	0.85	1.05
K	0.85	0.90	0.95
L	0.95	1.10	1.25
M	0.20	0.25	0.30
N	0.25	0.40	0.55
O	4.00	4.05	4.25

### Mounting Pad Layout

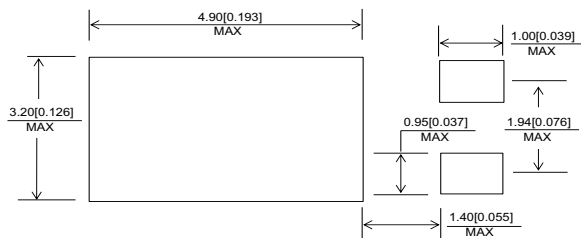

### Part Numbering and Marking System



**DST** = Device Type  
**5** = Forward Current (5A)  
**60** = Reverse Voltage (60V)  
**S** = Package Type  
**LF** = Littelfuse  
**YY** = Year  
**WW** = Week  
**L** = Lot Number

### Packing Options

Part Number	Marking	Packing Mode	M.O.Q
DST560S	DST560S	5000pcs / Reel	5000

### Carrier Tape & Reel Specification

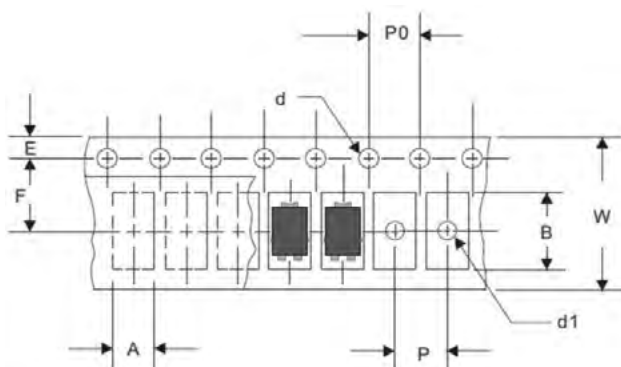

Symbol	Millimeters	
	Min	Max
<b>A</b>	4.28	4.48
<b>B</b>	6.80	7.00
<b>d</b>	1.40	1.60
<b>d1</b>	-	1.50
<b>E</b>	1.65	1.85
<b>F</b>	5.40	5.60
<b>P</b>	7.90	8.10
<b>P0</b>	3.90	4.10
<b>W</b>	11.70	12.30