

### DST5100S-A

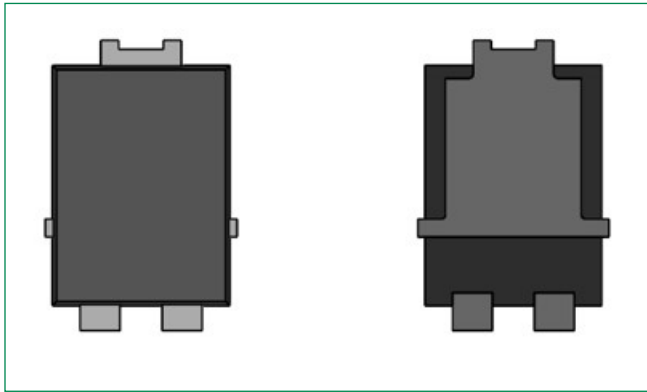

#### Features

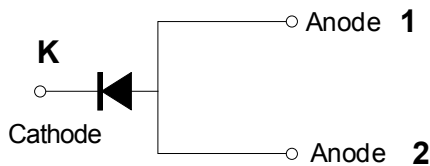

#### Description

Littelfuse DST series Ultra Low  $V_F$  Schottky Barrier Rectifier is designed to meet the general requirements of commercial and industrial applications by providing high temperature, low leakage and low  $V_F$  products.

It is suitable for high frequency switching mode power supply applications, as free-wheeling and polarity protection diodes.

#### Features

- High reliability application and AEC-Q101 qualified
- Ultra low forward voltage drop
- High frequency operation
- MSL: Level 1 - unlimited
- High junction temperature capability
- Trench MOS Barrier Schottky technology
- Single die in TO-277B Package
- Pb-free E3 means 2nd level interconnect is Pb-free and the terminal finish material is tin(Sn) (IPC/ JEDEC J-STD-609A.01)

#### Applications

- Switching mode power supply
- DC/DC converters
- Free-Wheeling diodes
- Polarity Protection Diodes

#### Maximum Ratings

Parameters	Symbol	Test Conditions	Max	Unit
Peak Inverse Voltage	$V_{RWM}$	-	100	V
Average Forward Current (per device) *	$I_{F(AV)}$	50% duty cycle @ $T_A = 25^\circ\text{C}$ rectangular wave form	5	A
Peak One Cycle Non-Repetitive Surge Current (per leg)	$I_{FSM}$	8.3 ms, half Sine pulse	120	A

\* Mounted on 30 mm x 30 mm pad areas aluminum PCB

#### Electrical Characteristics

Parameters	Symbol	Test Conditions	Typ	Max	Unit
Forward Voltage Drop (per leg) *	$V_{F1}$	@5A, Pulse, $T_J = 25^\circ\text{C}$	0.69	0.75	V
	$V_{F2}$	@5A, Pulse, $T_J = 125^\circ\text{C}$	0.61	0.70	
Reverse Current (per leg) *	$I_{R1}$	@ $V_R = \text{rated } V_R, T_J = 25^\circ\text{C}$	0.06	0.12	mA
	$I_{R2}$	@ $V_R = \text{rated } V_R, T_J = 125^\circ\text{C}$	2	18	
Junction Capacitance (per leg)	$C_T$	@ $V_R = 5V, T_C = 25^\circ\text{C}, f_{SIG} = 1\text{MHz}$	245	-	pF
Voltage Rate of Change	dv/dt		-	10000	V/ $\mu\text{s}$

\* Pulse Width < 300 $\mu\text{s}$ , Duty Cycle < 2%

**Thermal-Mechanical Specifications**

Parameters	Symbol	Test Conditions	Max	Unit
Junction Temperature	$T_J$	-	-55 to +150	°C
Storage Temperature	$T_{stg}$	-	-55 to +150	°C
Maximum Thermal Resistance Junction to Ambient	$R_{\theta JA}$	DC operation	75	°C/W
Maximum Thermal Resistance Junction to Lead	$R_{\theta JL}^*$		4	°C/W
Approximate Weight	wt	-	0.08	g
Case Style	TO-277B			

\*Lead temperature monitored at the cathode pin

**Figure 1: Forward Current Derating Curve**

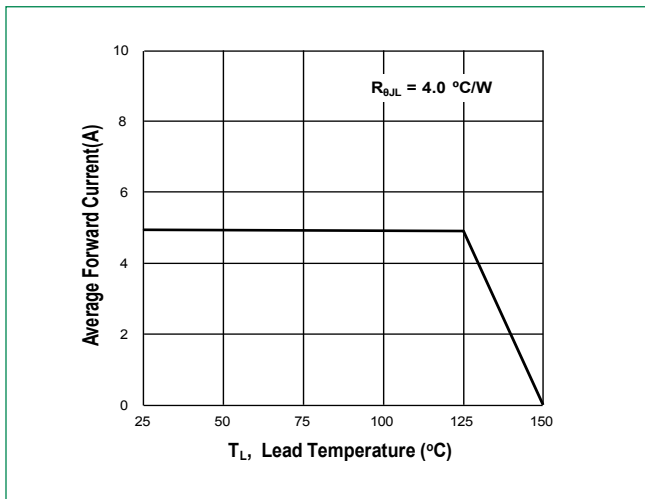

**Figure 2: Forward Power Loss Characteristics**

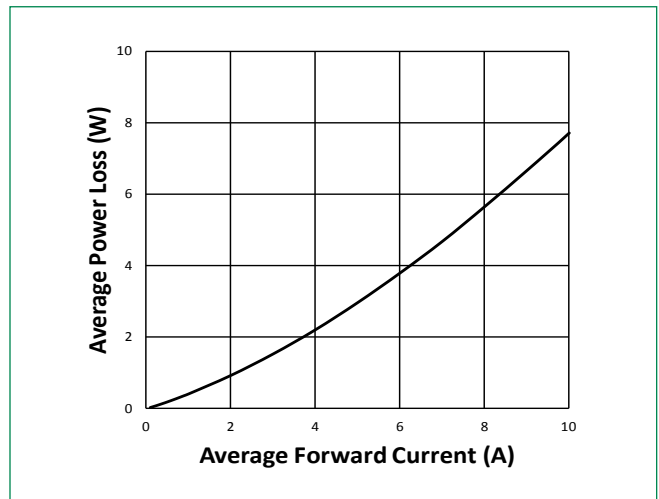

**Figure 3: Typical Junction Capacitance**

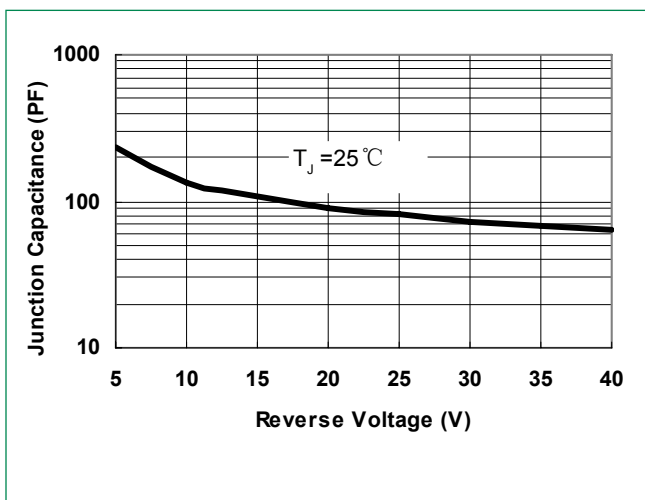

**Figure 4: Typical Reverse Characteristics**

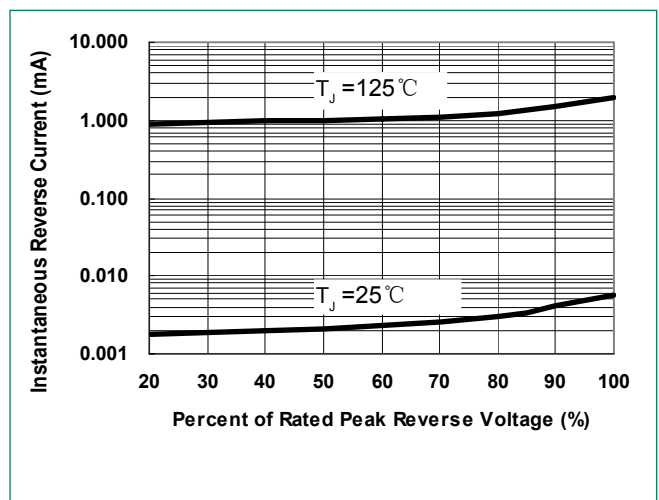

**Figure 3: Typical Instantaneous Forward Voltage Characteristics**

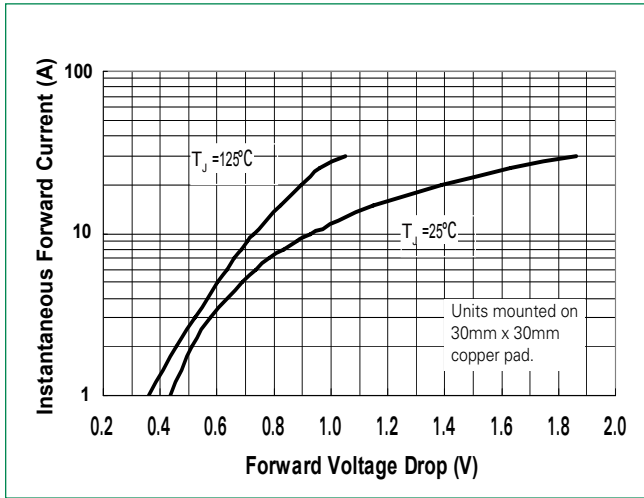

**Dimensions-TO-277B**

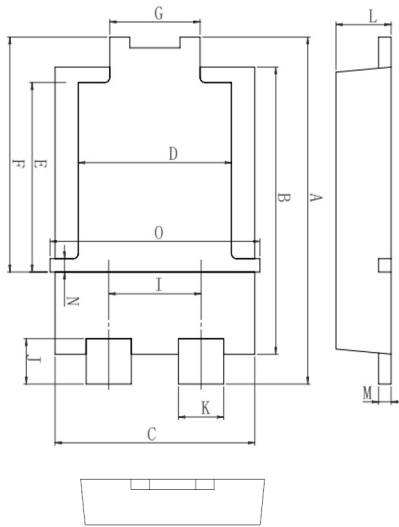

Symbol	Millimeters		
	Min	Typ	Max
A	6.30	6.50	6.70
B	5.28	5.38	5.48
C	3.88	3.98	4.08
D	2.90	3.05	3.20
E	3.40	3.55	3.70
F	4.20	4.40	4.60
G	1.70	1.80	1.90
I	1.74	1.84	1.94
J	0.65	0.85	1.05
K	0.85	0.90	0.95
L	0.95	1.10	1.25
M	0.20	0.25	0.30
N	0.25	0.40	0.55
O	4.00	4.05	4.25

**Mounting Pad Layout**

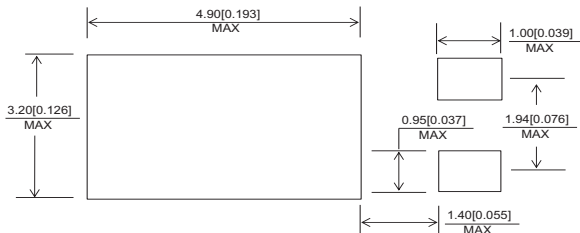

**Part Numbering and Marking System**

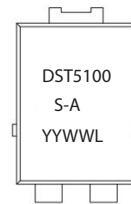

- DST = Device Type
- 5 = Forward Current (5A)
- 100 = Reverse Voltage (100V)
- S = Package Type
- A = AEC-Q101 qualified device
- YY = Year
- WW = Week
- L = Lot Number

### Packing Options

Part Number	Marking	Packing Mode	M.O.Q
DST5100S-A	DST5100S-A	5000pcs / Reel	5000

### Carrier Tape & Reel Specification

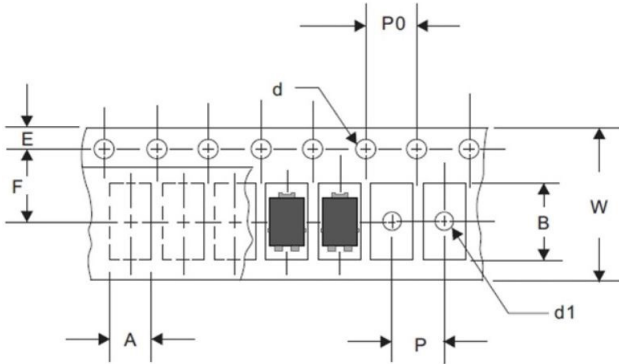

Symbol	Millimeters	
	Min	Max
A	4.28	4.48
B	6.80	7.00
d	1.40	1.60
d1	-	1.50
E	1.65	1.85
F	7.40	7.60
P	7.90	8.10
P0	3.90	4.10
W	15.70	16.30

#### Disclaimer Notice

Information furnished is believed to be accurate and reliable. However, users should independently evaluate the suitability of and test each product selected for their own applications. Littelfuse products are not designed for, and may not be used in, all applications. Read complete Disclaimer Notice at <http://www.littelfuse.com/disclaimer-electronics>.



Part of:

