

PLEDxUSW Series, Unidirectional, White DO-214AA

OBSOLETE DATE: 03/26/2020 PCN/ECN# 41325
REPLACED BY: PLED series



Description

The PLEDxUSW open LED protectors provide an electronic switching shunt path around a single LED that fails as an open circuit. This ensures the remaining string of LEDs will continue to function even though a single LED in the string has failed open. It also provides reverse battery or reverse power polarity protection.

It is designed to enable higher reliability in outdoor LED lighting applications such as street lighting, outdoor signage, aircraft runway lighting, roadside warning lights and other applications. Additionally, it is molded from white material to make it less visible in the LED fixture and the white molding also reflects more light to improve overall light engine efficiency.

This component is compatible with one, two and three watt LEDs that have a nominal 3V forward characteristic, PLEDxUSW is available in SMB surface mount package. The DO-214AA (SMB) low profile package is ideal for dense board applications.

Agency Approvals

Agency	Agency File Number
	E133083

Schematic Symbol

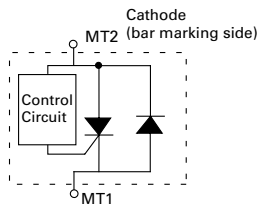

Features & Benefits

- Fast switching
- Reverse Battery/Power Protection
- Automatically resets after power cycle
- Low profile, small foot print standard DO-214AA package
- Compatible with industrial lighting environments
- IEC-61000-4-2 ESD 30kV (Air), 30kV (Contact)
- ESD protection of data lines in accordance with IEC 61000-4-2 (IEC801-2)
- Compatible with PWM frequencies up to 10 kHz
- RoHS compliant and halogen-free
- Moisture Sensitivity Level(MSL -1)

Electrical Characteristics (All parameters are measured at $T_A = 25^\circ\text{C}$ unless otherwise noted)

Part Number	Marking	V_{BR} breakdown		V_{DRM} breakdown	I_H	I_S	$I_T @ V_T$	$V_T @ I_T = 1A$	$I_F @ V_F$	$V_F @ I_F = 1A$	I_o^1	Critical rate of rise dV/dt
		Volts		Volts	mAmps	mAmps	Amps	Volts	Amps	Volts	Amps	Volts
		Min	Max	Min	Max	Max	Max	Max	Max	Max	Min	Max
PLED6USW	PL6UW	6	16	6	30	50	1.0	1.2	1.0	1.0	1.0	250V/ μ s

note:

1. I_o^1 - Operation current tested @ aluminum boards, ambient temp 85°C

Thermal Considerations

Package	Symbol	Parameter	Value	Unit
DO-214AA in White 	T_J	Operating Junction Temperature Range	-40 to +150	°C
	T_S	Storage Temperature Range	-65 to +150	°C
	$R_{\theta JA}$	Thermal Resistance: Junction to Ambient	DO-214AA: 90 ¹ DO-214AA: 40 ²	°C/W

Notes:

1) Standard FR-4 PCB with Copper Pads (Recommended Size)

2) Aluminum PCB

Thickness: 1.6mm

Grade: 1-2 W/mK Thermal Conductivity

Trace thickness: 2 oz

Insulation layer thickness: 215 um

Solder Pad Dimensions: 2.0mm x 2.8mm (Recommended Size)

V-I Characteristics

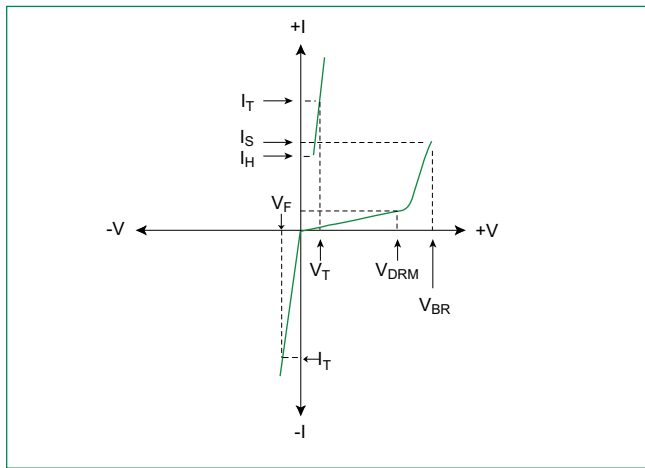

V_{BR} vs. Junction Temperature

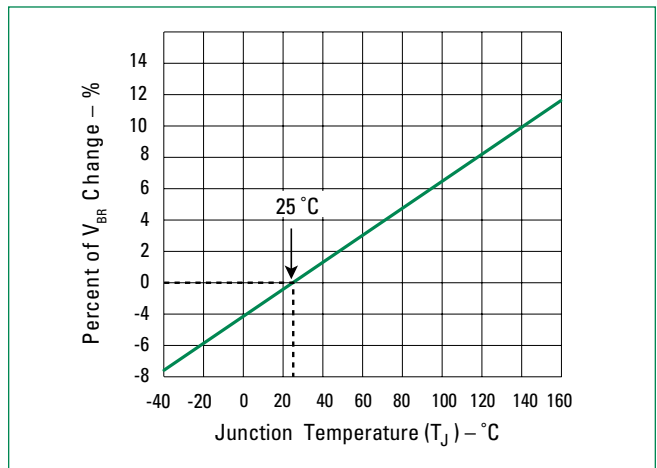

Normalized DC Holding Current vs. Case Temperature

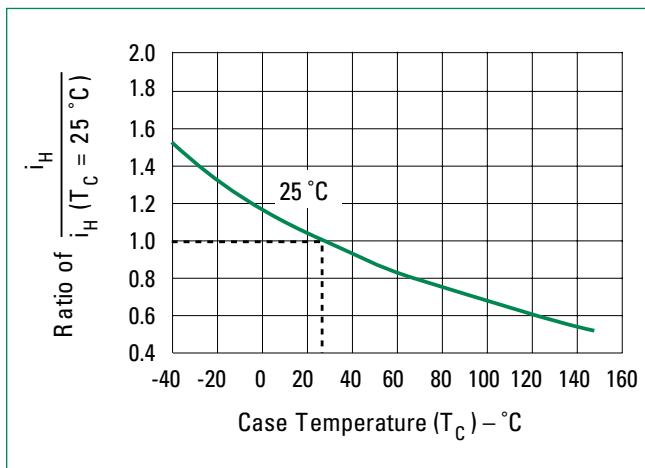

LED Interference Test Circuit

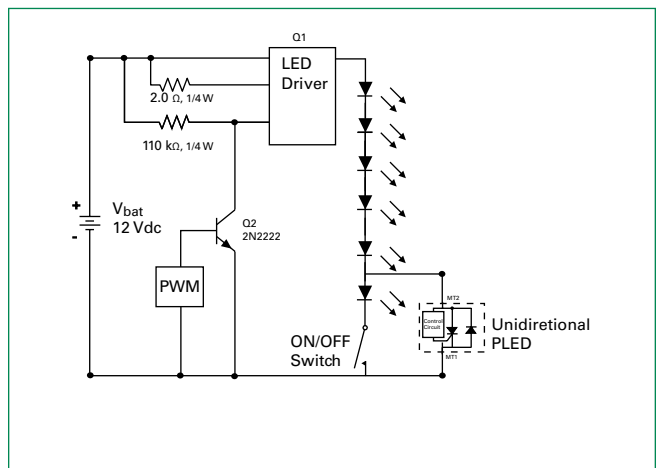

6 LEDs in Series 50% Duty Cycle 10kHz

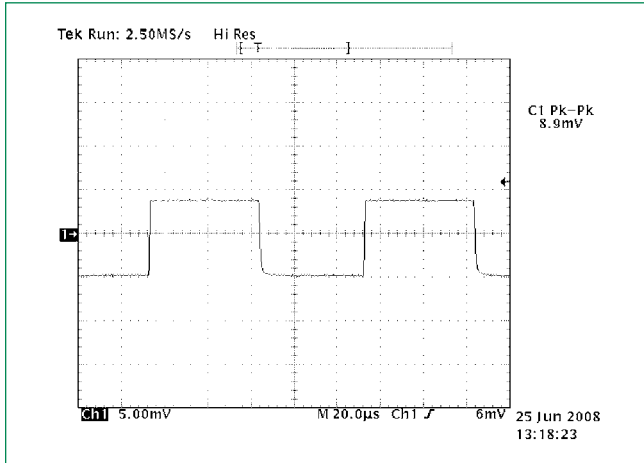

5 LEDs and 1 PLED in Series 50% Duty Cycle 10kHz

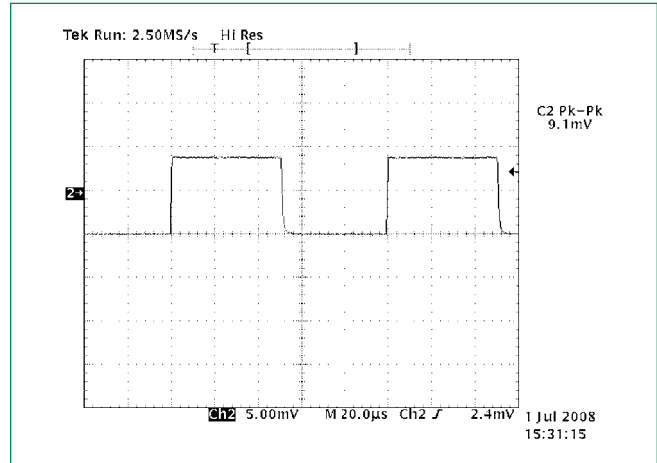

Note: These two graphs show the current magnitude through the LED string with and without the PLED included. There is no noticeable effect on the LED current magnitude when the PLED is included in the circuit as compared to the LED current magnitude when the PLED is not in the circuit. (The conversion factor for the test measurement in the graphs above is 10mA/mV for the Pearson coil measurement, therefore, the current magnitude in the first figure is 10mA*8.9 = 89mA, while the second figure is 91mA.)

PLED in the Off-State 10kHz

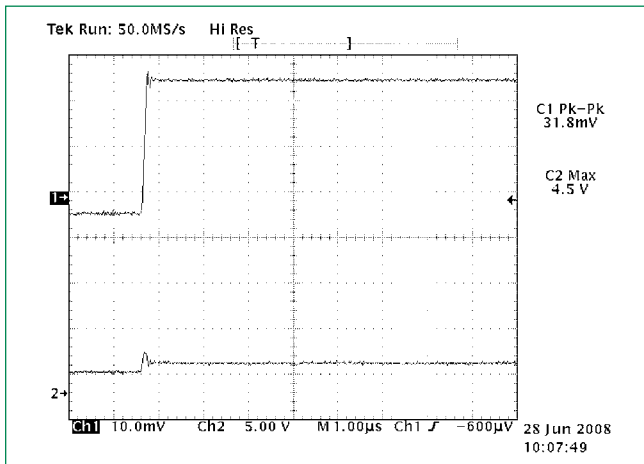

Channel 1: current through LEDs (318 mA)
Channel 2: voltage across PLED device (4.5 V)

PLED device zeners and then turns fully on 10kHz

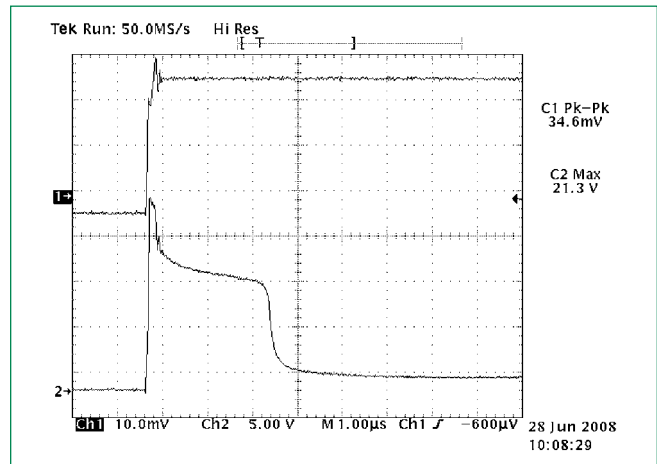

Channel 1: current through LEDs (346 mA) and PLED device once it is fully turned on 2.5 µsec later
Channel 2: voltage across PLED device (21.3 V before PLED crowbars with 2V drop)

Soldering Parameters

Reflow Condition		Pb – Free assembly
Pre Heat	- Temperature Min ($T_{s(min)}$)	150°C
	- Temperature Max ($T_{s(max)}$)	200°C
	- Time (min to max) (t_s)	60 – 180 secs
Average ramp up rate (Liquidus Temp (T_L) to peak)		3°C/second max
$T_{s(max)}$ to T_L - Ramp-up Rate		3°C/second max
Reflow	- Temperature (T_L) (Liquidus)	217°C
	- Temperature (t_l)	60 – 150 seconds
Peak Temperature (T_p)		260 ^{+0/-5} °C
Time within 5°C of actual peak Temperature (t_p)		30 seconds
Ramp-down Rate		6°C/second max
Time 25°C to peak Temperature (T_p)		8 minutes max
Do not exceed		260°C

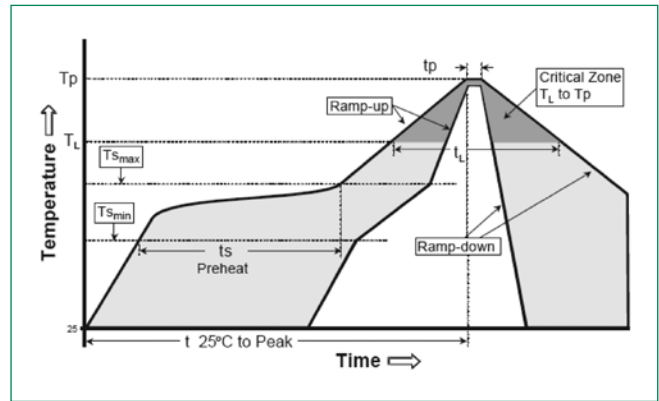

Physical Specifications

Terminal Material	Copper Alloy
Terminal Finish	100% Matte Tin Plated
Body Material	UL recognized compound meeting flammability classification V-0

Environmental Specifications

High Temperature Voltage Blocking	MIL-STD-750: Method 1040, Condition A 80% min V_{DRM} (VAC-peak), 150°C, 504 hours
Temperature Cycling	MIL-STD-750: Method 1051 -65°C to 150°C, 15-minute dwell, 100 cycles
Biased Temperature & Humidity	EIA/JEDEC: JESD22-A101 52VDC, 85°C, 85%RH, 1008 hours
High Temperature Storage	MIL-STD-750: Method 1031 150°C, 1008 hours
Low Temperature Storage	-65°C, 1008 hours
Thermal Shock	MIL-STD-750: Method 1056 0°C to 100°C, 5-minute dwell, 10-second transfer, 10 cycles
Resistance to Solder Heat	MIL-STD-750: Method 2031 260°C, 10 seconds

Part Numbering System

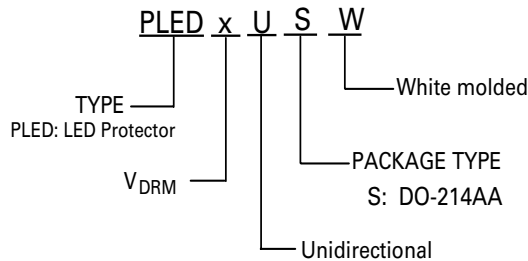

Part Marking System



Packaging

Package	Description	Packaging Quantity	Industry Standard
S	DO-214AA	2500	EIA-481-1

Dimensions - DO-214 AA Package

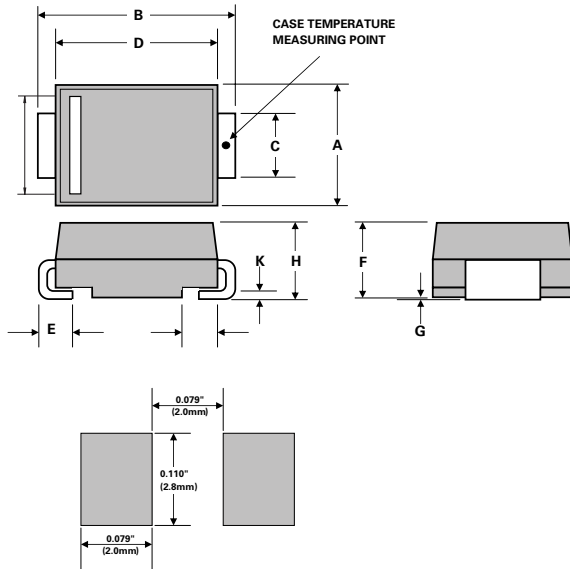

Dimensions	Inches		Millimeters	
	Min	Max	Min	Max
A	0.130	0.156	3.30	3.95
B	0.201	0.220	5.10	5.60
C	0.077	0.087	1.95	2.20
D	0.159	0.181	4.05	4.60
E	0.030	0.063	0.75	1.60
F	0.075	0.096	1.90	2.45
G	0.002	0.008	0.05	0.20
H	0.077	0.104	1.95	2.65
K	0.006	0.016	0.15	0.41

Recommended solder pad layout
(Reference Only)

DO-214AA Embossed Carrier Reel Pack (RP)

Meets all EIA-481-1 Standards

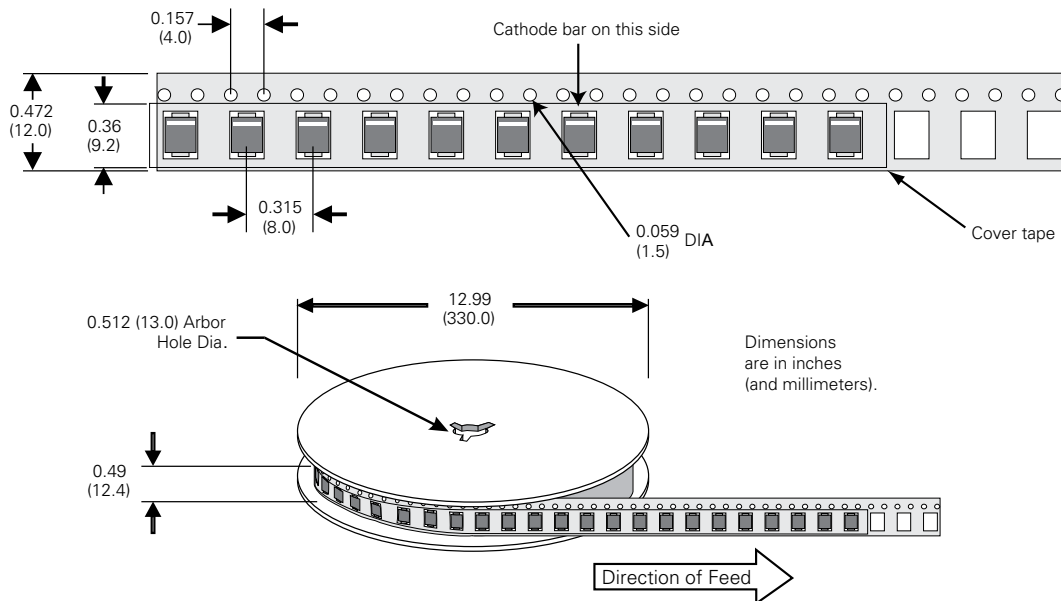

Dimensions are in inches (and millimeters).

Disclaimer Notice - Information furnished is believed to be accurate and reliable. However, users should independently evaluate the suitability of and test each product selected for their own applications. Littelfuse products are not designed for, and may not be used in, all applications. Read complete Disclaimer Notice at <http://www.littelfuse.com/disclaimer-electronics>.