

342 Military Series

Panel Mount Enclosed Fuseholders for 3AB/3AG/F02/F03 Fuses



Web Resources



Download ECAD models, order samples, and find technical resources at www.littelfuse.com

Agency Approvals

Agency	Agency File Number
	E14721*
	7316**

Notes:

* Only for 342024, 342021

** Only for 342024

Product Characteristics

	General Application Products	Watertight Product
Compatible Fuses	3AB/3AG/F02/F03	
Electrical	Rated up to 30 amp for any voltage up to 250 V	
Ambient Temperature	-40 °C to +85 °C	
Dielectric Strength	2400 volts minimum	1500 volts minimum
Mounting	Withstands 15 lb.-in. mounting torque; maximum panel thickness: 0.187"	Withstands 15 lb.-in. mounting torque; maximum panel thickness is 0.250"
Molded Parts	Grey thermoset (UL94 V-0)	
Seal	Neoprene washer provide drip-proof protection on the front side of the panel (upon request)	O-ring provides a watertight seal on the front side of the panel per MIL-PRF-19207
Terminals	Copper Alloy/Tin Plated	Copper Alloy/Tin Plated
Hardware	Comes with a mounting nut and neoprene washer	O-rings (2) and hex nut, unassembled
Ingression Protection Rating	IP52	IP67

342 Military Series

Panel Mount Enclosed Fuseholders for 3AB/3AG/F02/F03 Fuses

Dimensions

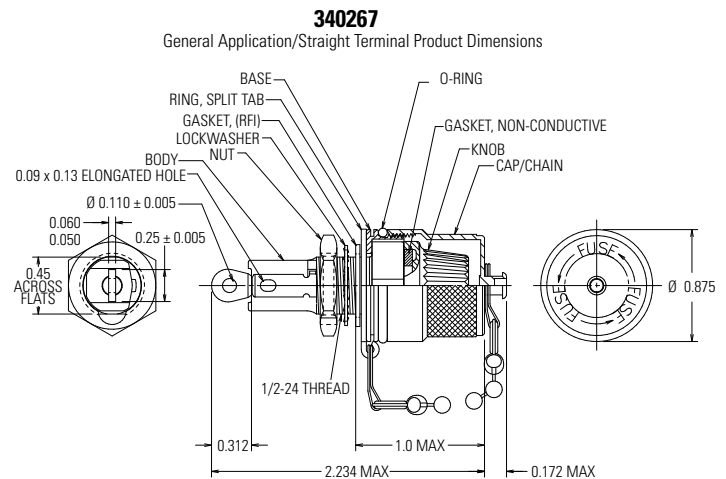
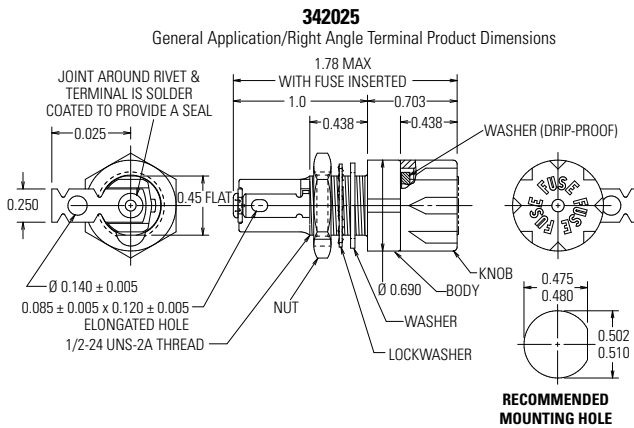
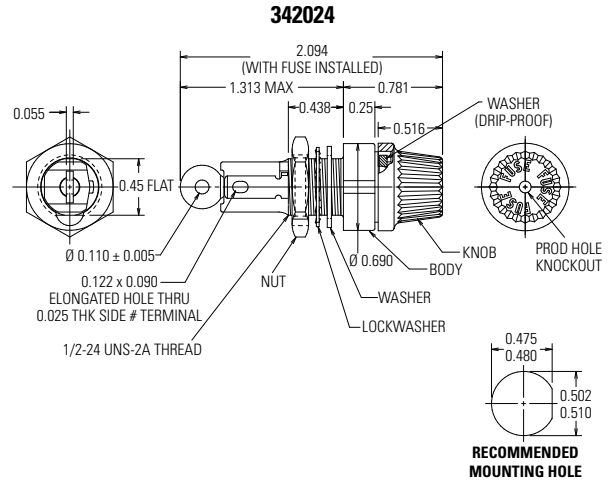
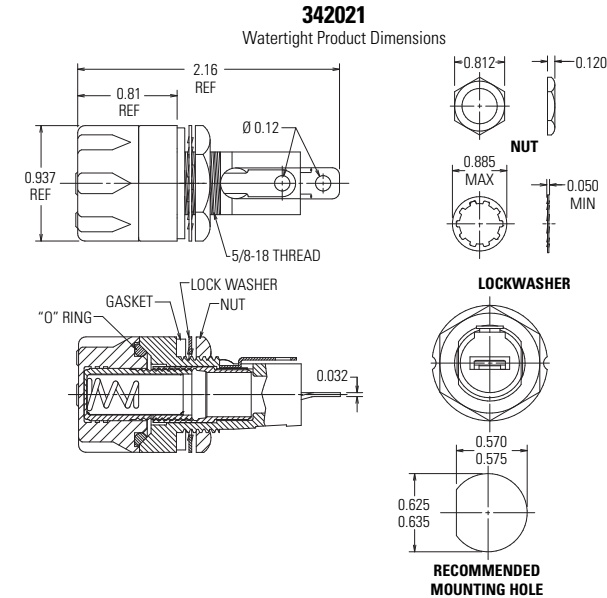

Ordering Information

MIL Specification	Type Designation	Catalog Number	Ordering Number	Type	Electrical Rating	Terminal Type	Knob Type
MIL-PRF19207/11	FHN20G	342025	03420025Z	Drip-proof	20 A 250 V	Right Angle-solder	Knurled
MIL-PRF19207/16	FHN26G2	342024	03420024Z	Drip-proof	30 A 250 V	Straight Angle-solder	Fluted
MIL-PRF19207/16	FHN26W	342021	03420021Z	Water Tight	30 A 250 V	Straight Angle-solder	Fluted
MIL-PRF19207/36	FHN55W	342027	03400267Z	Water Tight RFI	30 A 250 V	Straight Angle-solder	Fluted

Disclaimer Notice - Information furnished is believed to be accurate and reliable. However, users should independently evaluate the suitability of and test each product selected for their own applications. Littelfuse products are not designed for, and may not be used in, all applications. Read complete Disclaimer Notice at: www.littelfuse.com/disclaimer-electronics.