

**LCFEA Series**

RoHS



**Pinout**

**Two Lines**

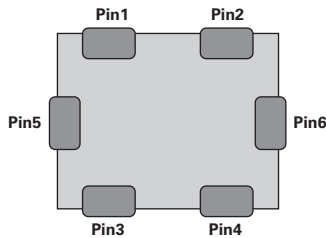

Item	Description	Source	Equipment
R <sub>dc</sub>	Pin 1-4, 2-3	10mA DC Source	Source Meter
CM Impedance	Pin 1-2(Short) to Pin 3-4(Short)	500mV	LCR Meter (3GHz)
IL	Pin 5 or 6 to Pin 1,2,3,4	5V DC Source	Source Meter
IR <sub>CR</sub>	Pin 1-2 or Pin 3-4	5V DC Source	Source Meter

**Four Lines**

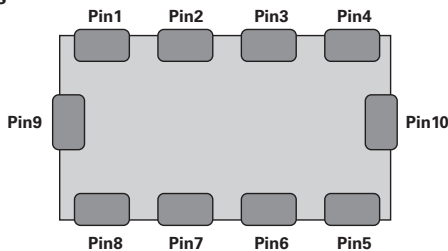

Item	Description	Source	Equipment
R <sub>dc</sub>	Pin 1-8, 2-7, 3-6, 4-5	10mA DC Source	Source Meter
CM Impedance	Pin 1-2(Short) to Pin 8-7(Short) Pin 3-4(Short) to Pin 6-5(Short)	500mV	LCR Meter (3GHz)
IL	Pin 9 or 10 to Pin 1~4 or 5~8	5V DC Source	Source Meter

**Description**

This specification covers the engineering requirements for both Common Mode Noise Filter (CMF) and ESD Protection especially for high speed differential serial interfaces, such as USB 3.1 , USB 2.0 , MIPI D-PHY or HDMI, and RGB line, LVDS line.

AEC-Q200 qualified common mode noise filter will help to choke and attenuate the noise for the growing number of electronic applications in modern vehicles.

**Features**

- AEC-Q200 qualified
- Effective for suppressing common mode noise and almost no effect for high speed differential data line
- Differential mode cut-off frequency up to 4.5GHz at -3dB
- Common mode filters and ESD suppression devices integrated
- Low profile package
- Ceramic multilayer type SMD component
- Non-polarized product
- Conforming to RoHS directive.
- ±15kV air, ±8kV contact ESD protection (IEC 61000-4-2 Level 4)
- High temperature soldering guaranteed: 260°C/10 seconds

**Applications**

- *Automotive*
  - Infotainment: Display, Car Navigation, Head Unit, USB Jack
  - ADAS: Car Camera System
  - Telematics Control Unit, E-Call system, Smart Keyless Entry system
  - RGB line, LVDS line, HDMI for AVN, High-speed CAN BUS line
- *Consumer*
  - PDP, LCD TV, DVD Player, PC, Audio player, DSC, Set top box, Laptop, SSD, Home Automation
- *Portable/Wearable Devices*
  - Mobile phone, Tablet, Game console, POS, VR, Dongle

## Functional Block Diagram

LCFEA121002A900TG, LCFEA201202A900TG

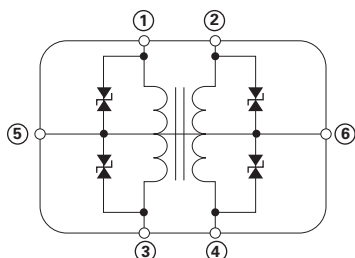

①~④: Data Line; ⑤, ⑥: Ground

LCFEA201204A101TG

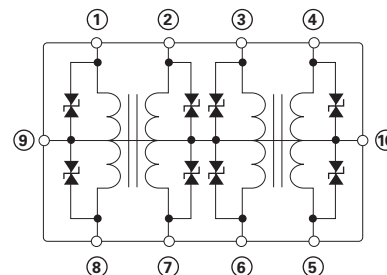

①~⑧: Data Line; ⑨, ⑩: Ground

## Electrical Characteristics

Part Number	Size (mm)	Size (inch)	Common Mode Impedance ( $\Omega$ )	Rated Current (mA) Max.	Cut-off Freq/GHz	DC Resistance ( $\Omega$ ) Max.	Number of Lines	Leakage Current ( $\mu$ A) Max.	Insulation Resistance (M $\Omega$ ) Min.	Rated Voltage (V)
LCFEA121002A900TG	1210	0504	90( $\pm$ 25%)	100	4.65	4.0	2	1.0	10	5
LCFEA201202A900TG	1212	0805	90( $\pm$ 25%)	150	4.65	4.0	2	1.0	10	5
LCFEA201204A101TG	2012	0805	90( $\pm$ 25%)	100	3.38	4.0	4	1.0	10	5

### Test Conditions

- Common Mode Impedance ( $\Omega$ ): @100MHz
- DC Resistance ( $\Omega$ ): 25°C $\pm$ 2°C
- Leakage Current ( $\mu$ A): 5V
- Capacitance (pF): 0.5Vrms @1MHz
- Insulation Resistance (Max. M $\Omega$ ): 5V
- Rated Voltage(V): 25°C $\pm$ 2°C
- Rated Current (mA): 25°C $\pm$ 2°C

**Impedance Curves**  
**Common Mode**

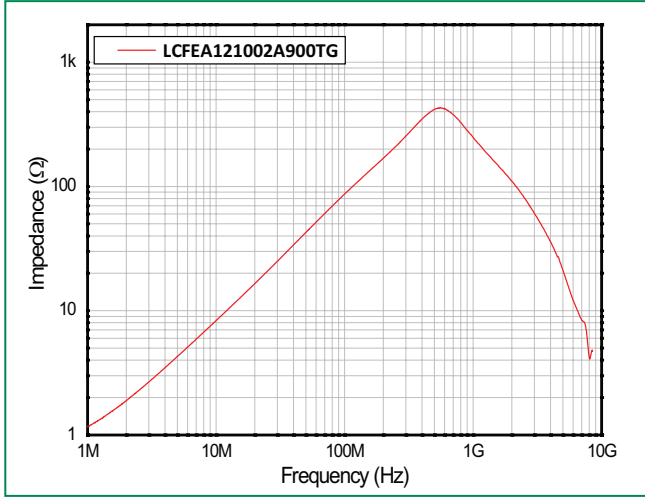

**Differential Mode**

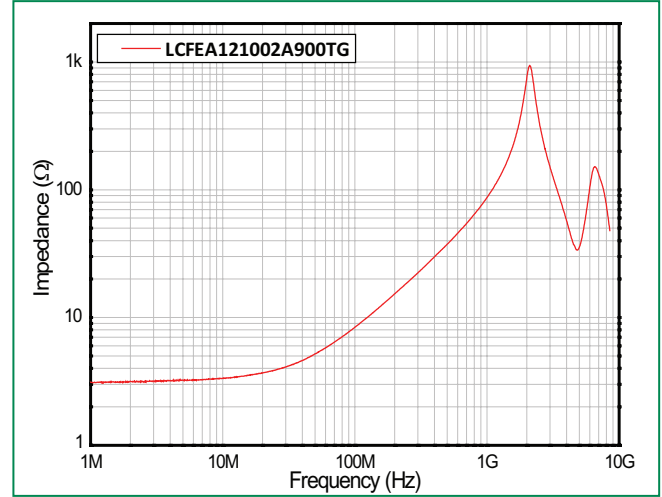

**Transmission Characteristics (S-parameter)**  
**Common Mode S21**

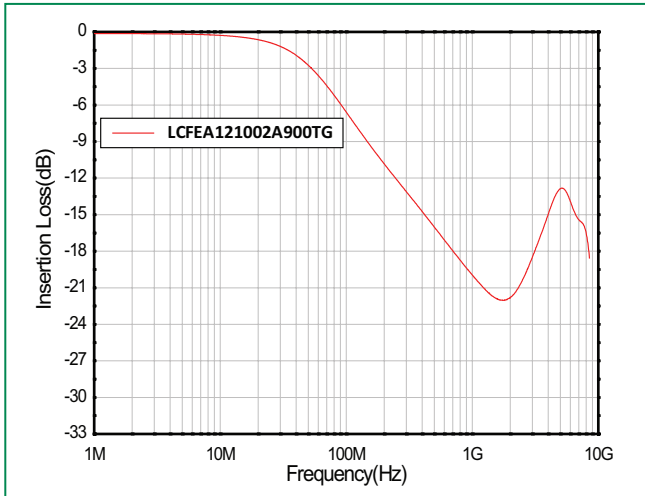

**Differential Mode S21**

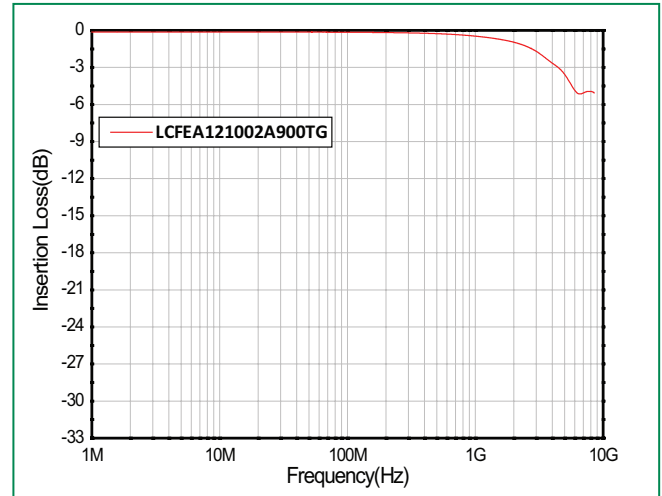

### Impedance Curves Common Mode

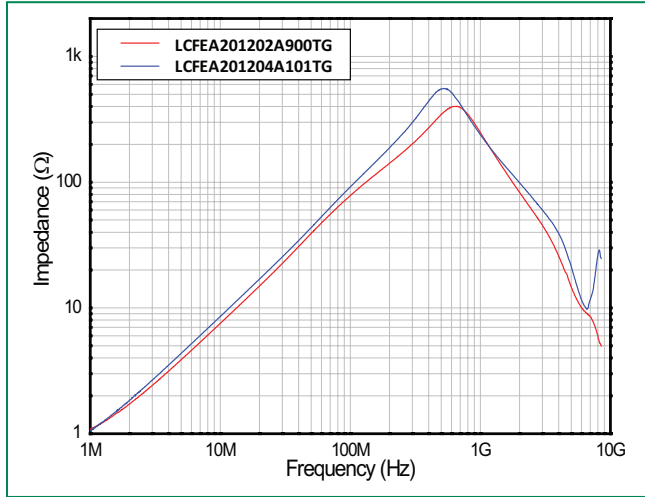

### Differential Mode

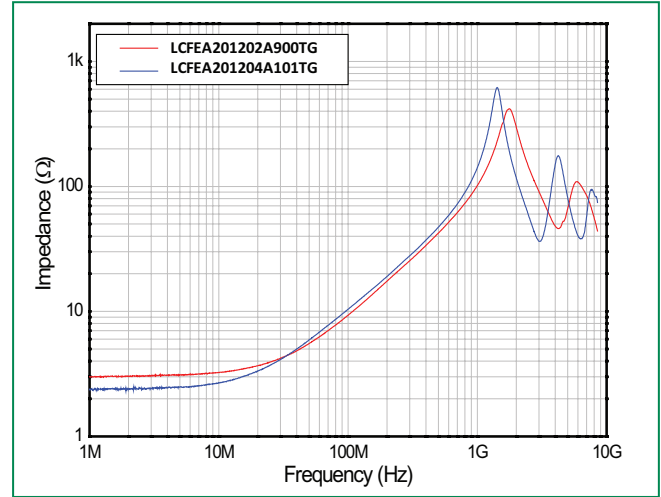

### Transmission Characteristics (S-parameter) Common Mode S21

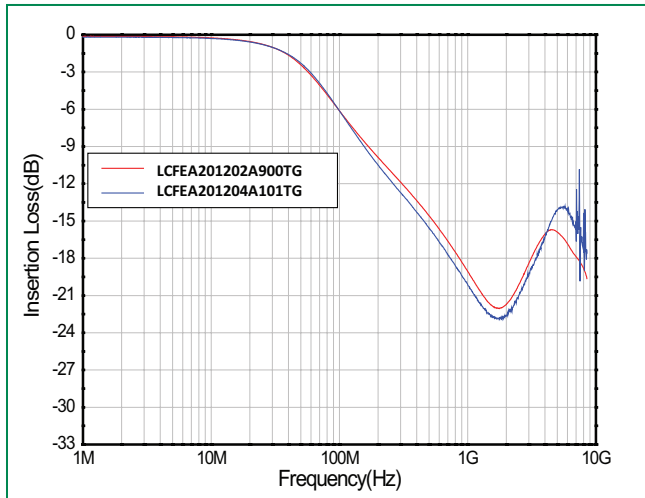

### Differential Mode S21

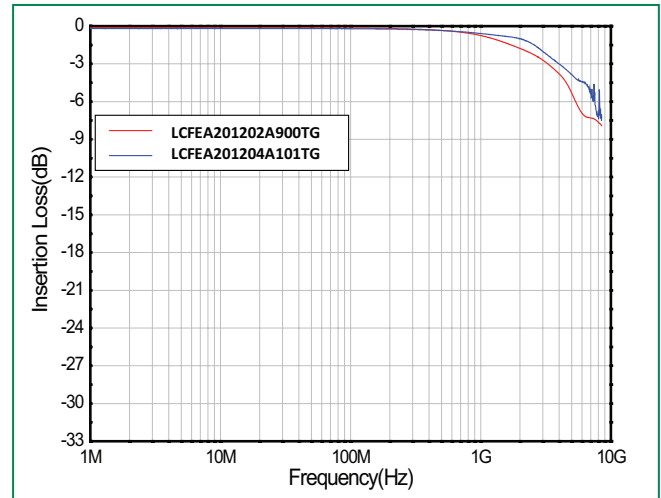

### Soldering Parameters

Reflow Condition		Pb-free assembly
Pre Heat	- Temperature Min ( $T_{s(min)}$ )	160°C
	- Temperature Max ( $T_{s(max)}$ )	185°C
	- Time (Min to Max) ( $t_s$ )	100 – 120 seconds
Average Ramp-up Rate (Liquidus Temp ( $T_L$ ) to peak)		1°C/second max
$T_{s(max)}$ to $T_L$ - Ramp-up Rate		1°C/second max
Reflow	- Temperature ( $T_L$ ) (Liquidus)	220°C
	- Temperature ( $t_L$ )	30 – 50 seconds
Peak Temperature ( $T_P$ )		260°C
Time within 5°C of actual peak Temperature ( $t_p$ )		5~10 seconds
Ramp-down Rate		2°C/second max
Time 25°C to Peak Temperature ( $T_P$ )		4 minutes max
Do not exceed		260°C
Wave Soldering		260°C, 10 sec. max

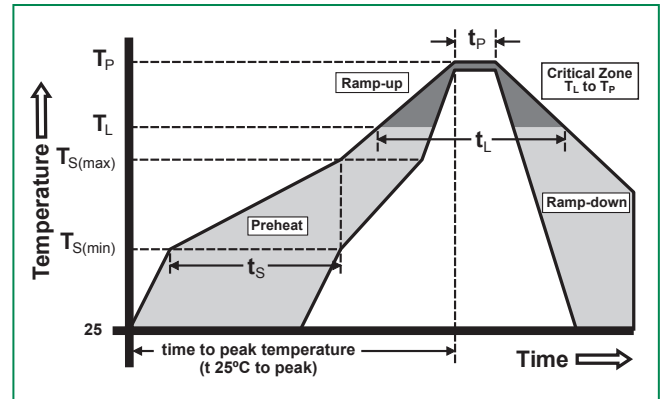

Recommended Soldering Profile ( Lead free condition)

### Product Characteristics

<b>Lead Pull Strength</b>	5N
<b>Solderability</b>	260°C, ≤10s (Reflow), Max 380°C, ≤5s (Soldering iron)
<b>Soldering Heat Resistance</b>	Max 260°C 10sec (Wave), Max Temperature: Max 380°C (Max 5sec)
<b>Operating Temperature</b>	-40°C ~ + 125°C
<b>Climatic Category</b>	-40°C ~ + 85°C/8 days
<b>Stock Conditions</b>	-10°C ~ + 40°C RH, ≤ 70%
<b>Vibration Resistance</b>	5 g's for 20 minutes, 12 cycles each of 3 orientations

### Dimensions

Unit = mm

LCFEA121002A900TG

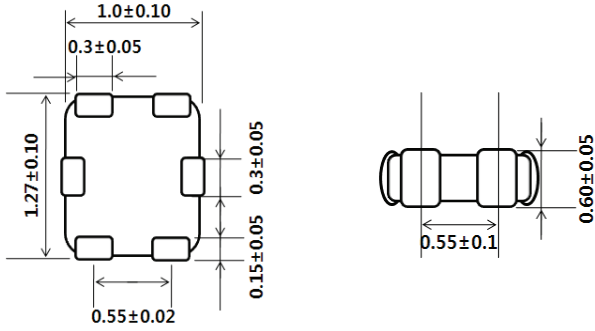

LCFEA201202A900TG

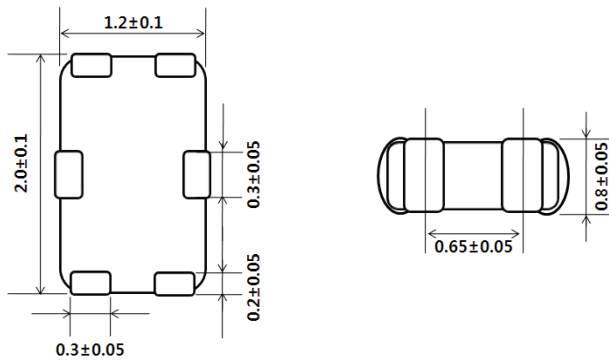

LCFEA201204A101TG

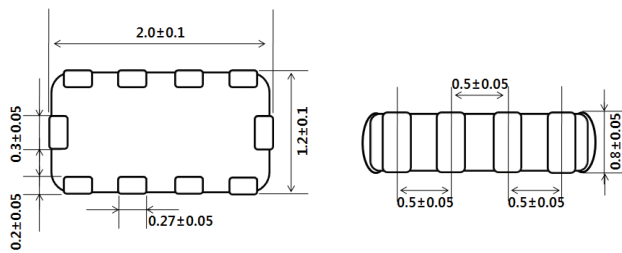

### Recommended Footprint and Stencil Mask

Unit = mm

Stencil Mask T = 0.10mm

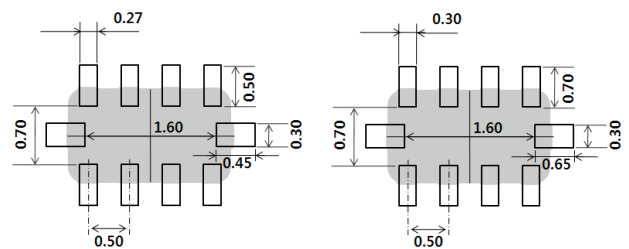
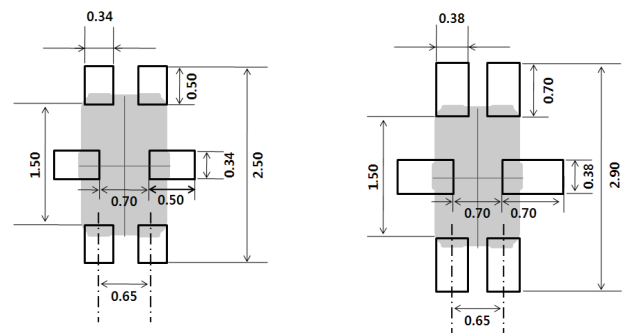
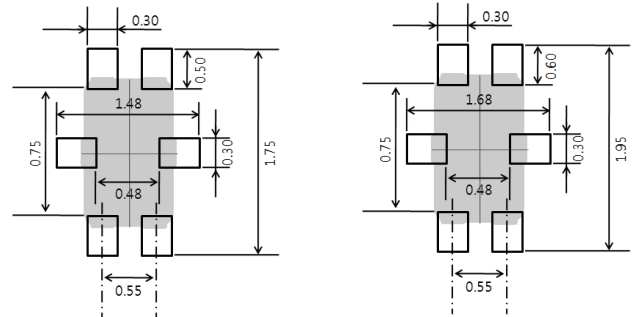

### Carrie Tape Dimensions

LCFEA121002A900TG

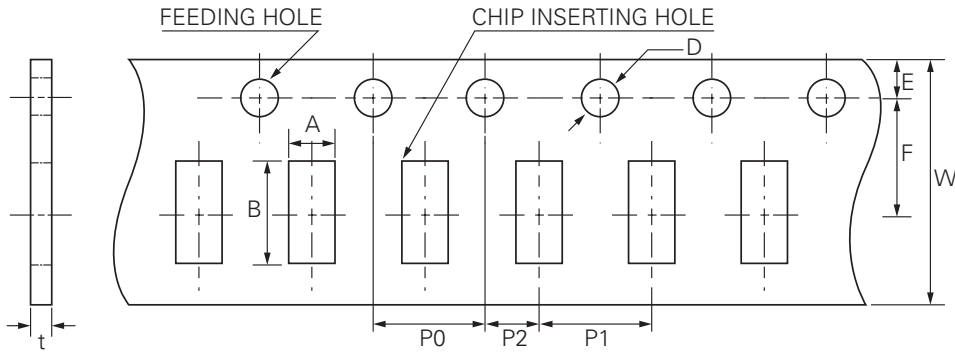

Symbol	Dimensions
	Millimeters
A	1.15±0.05
B	1.50±0.05
W	8.0+0.30, .0.10
F	3.50±0.05
E	1.75±0.05
P1	4.00±0.10
P2	2.00±0.05
P0	4.00±0.10
D	1.55±0.03
T	0.75±0.05

LCFEA201202A900TG, LCFEA201204A101TG

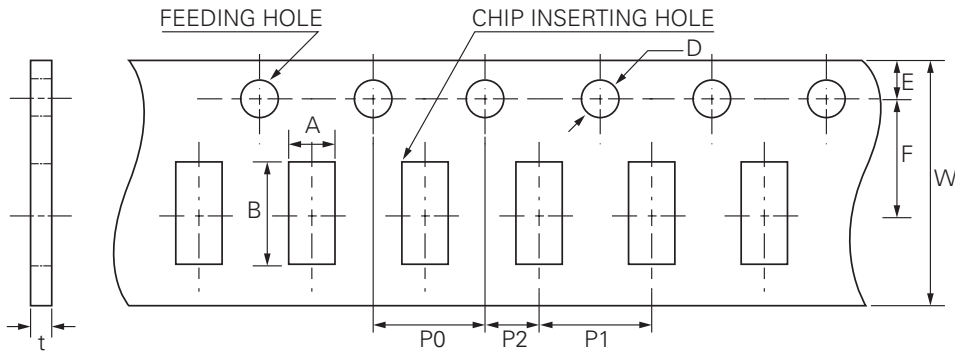

Symbol	Dimensions
	Millimeters
A	1.55±0.05
B	2.30±0.05
W	8.00±0.10
F	3.50±0.05
E	1.75±0.05
P1	4.00±0.10
P2	2.00±0.05
P0	4.00±0.10
D	1.55±0.03
T	0.95±0.05

### Tape and Reel Dimension

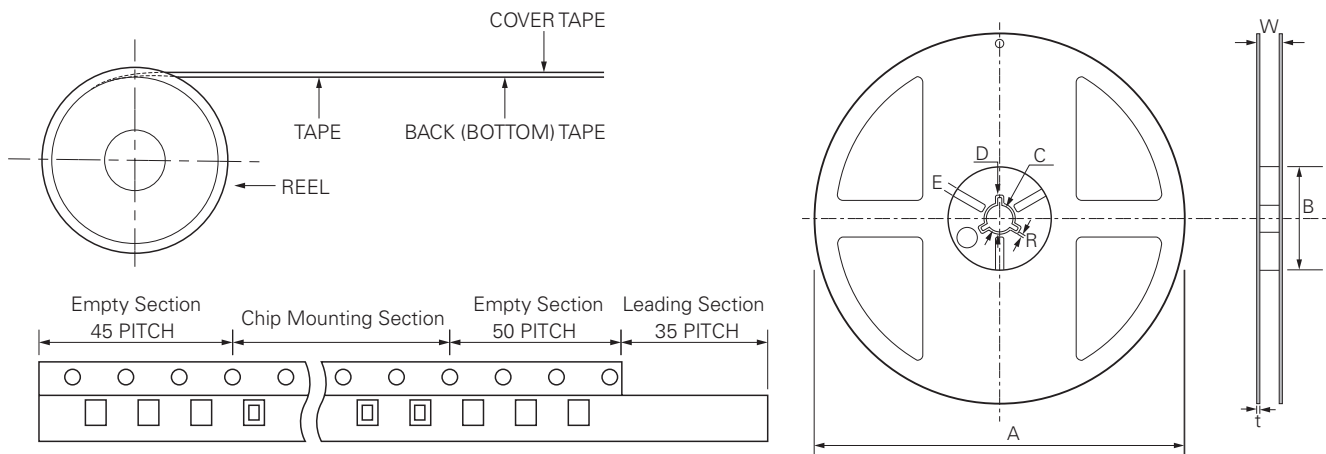

(1) Reel Materials: Polystyrene (2) Label (3) Taping  
- Standard Packing Quantity per Reel (Ø178)  
- PE Tape: 4,000pcs

Code	A	B	C	D	E	W	T	R
Dimension	Ø178±2	Min. Ø50	Ø13±0.5	Ø20±0.8	3.0±0.5	10±1.5	1.3±0.2	1.0±0.2

**Part Numbering System**

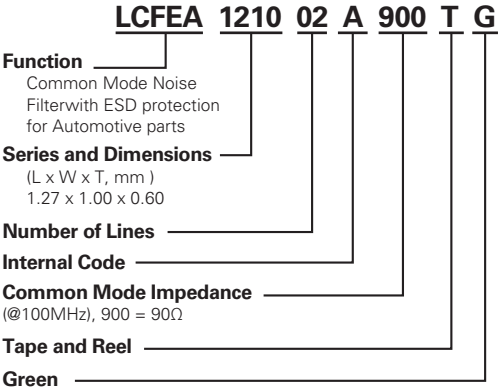

**Ordering Information**

Part Number	Reel Quantity
	4,000