

Wespack Phase Control Thyristor

Types N6974HK020 to N6974HK060

Absolute Maximum Ratings

| | VOLTAGE RATINGS | MAXIMUM LIMITS | UNITS |
|------------------|---|----------------|-------|
| V _{DRM} | Repetitive peak off-state voltage, (note 1) | 200-600 | V |
| V _{DSM} | Non-repetitive peak off-state voltage, (note 1) | 200-600 | V |
| V _{RRM} | Repetitive peak reverse voltage, (note 1) | 200-600 | V |
| V _{RSM} | Non-repetitive peak reverse voltage, (note 1) | 300-700 | V |

| | OTHER RATINGS | MAXIMUM LIMITS | UNITS |
|-----------------------|--|-------------------------|------------------|
| I _{T(AV)M} | Maximum average on-state current, T _{sink} =55°C, (note 2) | 6974 | A |
| I _{T(AV)M} | Maximum average on-state current. T _{sink} =85°C, (note 2) | 5030 | A |
| I _{T(AV)M} | Maximum average on-state current. T _{sink} =85°C, (note 3) | 2647 | A |
| I _{T(RMS)M} | Nominal RMS on-state current, T _{sink} =25°C, (note 2) | 13608 | A |
| I _{T(d.c.)} | D.C. on-state current, T _{sink} =25°C, (note 4) | 10923 | A |
| I _{TSM} | Peak non-repetitive surge t _p =10ms, V _{rm} =60%V _{RRM} , (note 5) | 65.0 | kA |
| I _{TSM2} | Peak non-repetitive surge t _p =10ms, V _{rm} ≤10V, (note 5) | 71.5 | kA |
| I ² t | I ² t capacity for fusing t _p =10ms, V _{rm} =60%V _{RRM} , (note 5) | 21.13×10 ⁶ | A ² s |
| I ² t | I ² t capacity for fusing t _p =10ms, V _{rm} ≤10V, (note 5) | 25.56×10 ⁶ | A ² s |
| (di/dt) _{cr} | Critical rate of rise of on-state current (note 6) | (continuous, 50Hz) | 100 |
| | | (repetitive, 50Hz, 60s) | 200 |
| | | (non-repetitive) | 400 |
| V _{RGM} | Peak reverse gate voltage | 5 | V |
| P _{G(AV)} | Mean forward gate power | 4 | W |
| P _{GM} | Peak forward gate power | 30 | W |
| T _{j op} | Operating temperature range | -40 to +140 | °C |
| T _{stg} | Storage temperature range | -40 to +150 | °C |

Notes:-

- 1) De-rating factor of 0.13% per °C is applicable for T_j below 25°C.
- 2) Double side cooled, single phase; 50Hz, 180° half-sinewave.
- 3) Cathode side cooled, single phase; 50Hz, 180° half-sinewave.
- 4) Double side cooled.
- 5) Half-sinewave, 140°C T_j initial.
- 6) V_D=67% V_{DRM}, I_{TM}=2000A, I_{FG}=2A, t_r≤0.5µs, T_{case}=140°C.

Characteristics

| | PARAMETER | MIN. | TYP. | MAX. | TEST CONDITIONS (Note 1) | UNITS |
|-----------------------|--|------|------|--------|--|------------------------|
| V _{TM} | Maximum peak on-state voltage | - | - | 0.95 | I _{TM} =4000A | V |
| V _{TM} | Maximum peak on-state voltage | - | - | 1.45 | I _{TM} =20900A | V |
| V _{T0} | Threshold voltage | - | - | 0.853 | | V |
| r _T | Slope resistance | - | - | 0.029 | | mΩ |
| (dv/dt) _{cr} | Critical rate of rise of off-state voltage | 1000 | - | - | V _D =80% V _{DRM} , linear ramp, gate o/c | V/μs |
| I _{DRM} | Peak off-state current | - | - | 100 | Rated V _{DRM} | mA |
| I _{RRM} | Peak reverse current | - | - | 100 | Rated V _{RRM} | mA |
| V _{GT} | Gate trigger voltage | - | - | 3.0 | T _j =25°C V _D =10V, I _T =3A | V |
| I _{GT} | Gate trigger current | - | - | 300 | | mA |
| V _{GD} | Gate non-trigger voltage | - | - | 0.25 | | Rated V _{DRM} |
| I _H | Holding current | - | - | 1000 | T _j =25°C | mA |
| t _{gd} | Gate-controlled turn-on delay time | - | 0.6 | 1.5 | V _D =67% V _{DRM} , I _T =2000A, di/dt=10A/μs, I _{FG} =2A, t _r =0.5μs, T _j =25°C | μs |
| t _{gt} | Turn-on time | - | 1.0 | 2.0 | | μs |
| Q _{rr} | Recovered charge | - | 1700 | - | I _{TM} =2000A, t _p =2000μs, di/dt=10A/μs, V _r =100V | μC |
| Q _{ra} | Recovered charge, 50% Chord | - | 1000 | 1250 | | μC |
| I _{rr} | Reverse recovery current | - | 105 | - | | A |
| t _{rr} | Reverse recovery time, 50% Chord | - | 19 | - | | μs |
| t _q | Turn-off time | - | 200 | - | I _{TM} =2000A, t _p =2000μs, di/dt=10A/μs, V _r =100V, V _{dr} =80%V _{DRM} , dV _{dr} /dt=20V/μs | μs |
| | | - | 250 | - | I _{TM} =2000A, t _p =2000μs, di/dt=10A/μs, V _r =100V, V _{dr} =80%V _{DRM} , dV _{dr} /dt=200V/μs | |
| R _{thJK} | Thermal resistance, junction to heatsink | - | - | 0.0090 | Double side cooled | K/W |
| | | - | - | 0.0167 | Anode side cooled | K/W |
| | | - | - | 0.0199 | Cathode side cooled | K/W |
| F | Mounting force | 36 | - | 44 | Note 2. | kN |
| W _t | Weight | - | 550 | - | | g |

Notes:-

- 1) Unless otherwise indicated T_j=140°C.
- 2) For other clamp forces, please consult factory.

Notes on Ratings and Characteristics

1.0 Voltage Grade Table

| Voltage Grade | V_{DRM} V_{DSM} V_{RRM} V | V_{RSM} V | V_D V_R DC V |
|---------------|------------------------------------|----------------|---------------------|
| 02 | 200 | 300 | 140 |
| 04 | 400 | 500 | 260 |
| 06 | 600 | 700 | 420 |

2.0 Extension of Voltage Grades

This report is applicable to other voltage grades when supply has been agreed by Sales/Production.

3.0 De-rating Factor

A blocking voltage de-rating factor of 0.13%/°C is applicable to this device for T_j below 25°C.

4.0 Repetitive dv/dt

Standard dv/dt is 1000V/μs.

5.0 Snubber Components

When selecting snubber components, care must be taken not to use excessively large values of snubber capacitor or excessively small values of snubber resistor. Such excessive component values may lead to device damage due to the large resultant values of snubber discharge current. If required, please consult the factory for assistance.

6.0 Rate of rise of on-state current

The maximum un-primed rate of rise of on-state current must not exceed 400A/μs at any time during turn-on on a non-repetitive basis. For repetitive performance, the on-state rate of rise of current must not exceed 200A/μs at any time during turn-on. Note that these values of rate of rise of current apply to the total device current including that from any local snubber network.

7.0 Gate Drive

The nominal requirement for a typical gate drive is illustrated below. An open circuit voltage of at least 30V is assumed. This gate drive must be applied when using the full di/dt capability of the device.

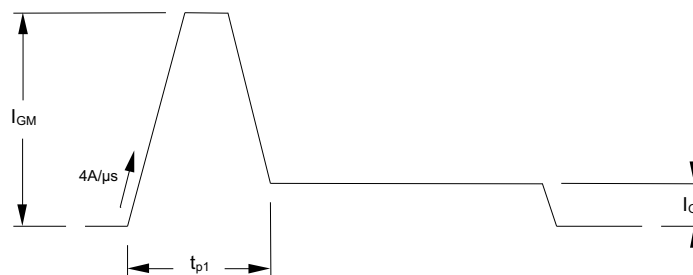

The magnitude of I_{GM} should be between five and ten times I_{GT} , which is shown on page 2. Its duration (t_{p1}) should be 20μs or sufficient to allow the anode current to reach ten times I_L , whichever is greater. Otherwise, an increase in pulse current could be needed to supply the necessary charge to trigger. The 'back-porch' current I_G should remain flowing for the same duration as the anode current and have a magnitude in the order of 1.5 times I_{GT} .

8.0 Computer Modelling Parameters

8.1 Device Dissipation Calculations

$$I_{AV} = \frac{-V_{T0} + \sqrt{V_{T0}^2 + 4 \cdot ff^2 \cdot r_T \cdot W_{AV}}}{2 \cdot ff^2 \cdot r_T}$$

and:

$$W_{AV} = \frac{\Delta T}{R_{th}}$$

$$\Delta T = T_{j\max} - T_K$$

Where $V_{T0}=0.853V$, $r_T=0.029\Omega$,

R_{th} = Supplementary thermal impedance, see table below and

ff = Form factor, see table below.

| Supplementary Thermal Impedance | | | | | | | |
|---------------------------------|--------|--------|--------|--------|--------|--------|--------|
| Conduction Angle | 30° | 60° | 90° | 120° | 180° | 270° | d.c. |
| Square wave Double Side Cooled | 0.0116 | 0.0110 | 0.0104 | 0.0099 | 0.0095 | 0.0092 | 0.0090 |
| Square wave Cathode Side Cooled | 0.0226 | 0.0220 | 0.0215 | 0.0210 | 0.0206 | 0.0202 | 0.0199 |
| Sine wave Double Side Cooled | 0.0110 | 0.0103 | 0.0097 | 0.0093 | 0.0091 | | |
| Sine wave Cathode Side Cooled | 0.0224 | 0.0218 | 0.0213 | 0.0208 | 0.0203 | | |

| Form Factors | | | | | | | |
|------------------|------|------|------|------|------|------|------|
| Conduction Angle | 30° | 60° | 90° | 120° | 180° | 270° | d.c. |
| Square wave | 3.46 | 2.45 | 2 | 1.73 | 1.41 | 1.15 | 1 |
| Sine wave | 3.98 | 2.78 | 2.22 | 1.88 | 1.57 | | |

8.2 Calculating V_T using ABCD Coefficients

The on-state characteristic I_T vs. V_T , on page 6 is represented in two ways;

- (i) the well established V_{T0} and r_T tangent used for rating purposes and
- (ii) a set of constants A, B, C, D, forming the coefficients of the representative equation for V_T in terms of I_T given below:

$$V_T = A + B \cdot \ln(I_T) + C \cdot I_T + D \cdot \sqrt{I_T}$$

The constants, derived by curve fitting software, are given below for both hot and cold characteristics. The resulting values for V_T agree with the true device characteristic over a current range, which is limited to that plotted.

| 25°C Coefficients | | 140°C Coefficients | |
|-------------------|---------------------------|--------------------|---------------------------|
| A | 1.027456155 | A | 0.421252755 |
| B | -0.03413891 | B | 0.05059778 |
| C | -9.14833×10^{-7} | C | 2.366256×10^{-5} |
| D | 5.482134×10^{-3} | D | 2.282612×10^{-4} |

8.3 D.C. Thermal Impedance Calculation

$$r_t = \sum_{p=1}^{p=n} r_p \cdot \left(1 - e^{-\frac{t}{\tau_p}} \right)$$

Where $p = 1$ to n , n is the number of terms in the series and:

t = Duration of heating pulse in seconds.

r_t = Thermal resistance at time t .

r_p = Amplitude of p^{th} term.

τ_p = Time Constant of r^{th} term.

The coefficients for this device are shown in the tables below:

| D.C. Double Side Cooled | | | | | |
|-------------------------|---------------------------|---------------------------|---------------------------|---------------------------|---------------------------|
| Term | 1 | 2 | 3 | 4 | 5 |
| r_p | 5.614572×10^{-3} | 1.997527×10^{-3} | 5.107445×10^{-4} | 6.836655×10^{-4} | 2.222810×10^{-4} |
| τ_p | 0.4270572 | 0.1626077 | 0.06369585 | 8.526047×10^{-3} | 1.634773×10^{-3} |

| D.C. Double Side Cooled | | | |
|-------------------------|------------|---------------------------|---------------------------|
| Term | 1 | 2 | 3 |
| r_p | 0.01495804 | 3.965149×10^{-3} | 1.012346×10^{-3} |
| τ_p | 2.244097 | 0.1756471 | 5.699736×10^{-3} |

9.0 Reverse recovery ratings

(i) Q_{ra} is based on 50% I_{RM} chord as shown in Fig. 1

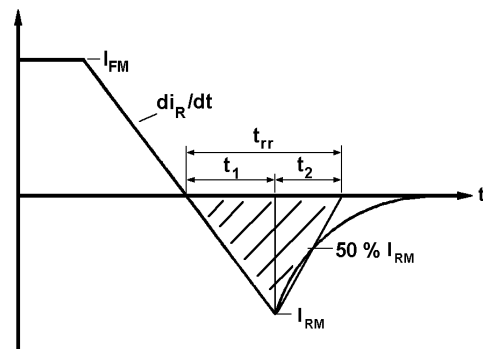

Fig. 1

(ii) Q_{rr} is based on a $150\mu s$ integration time i.e.

$$Q_{rr} = \int_0^{150\mu s} i_{rr} \cdot dt$$

(iii) $K \text{ Factor} = \frac{t_1}{t_2}$

Curves

Figure 1 – On-state characteristics of Limit device

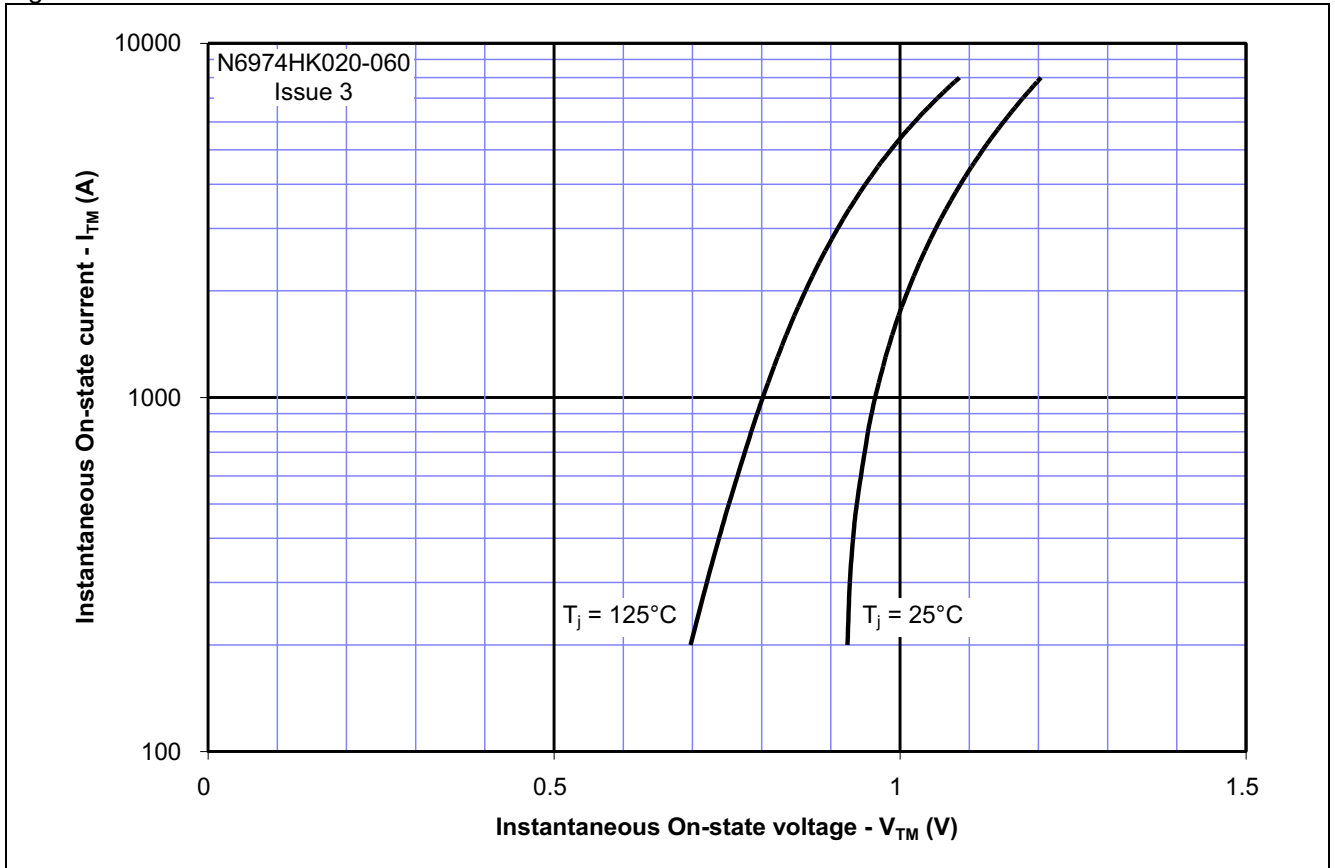

Figure 2 – Gate Characteristics – Trigger limits

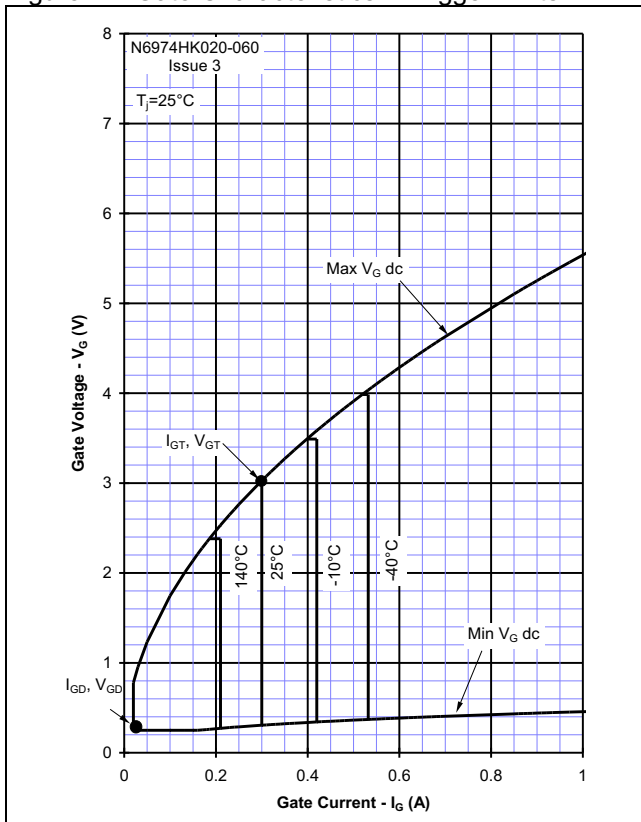

Figure 3 – Gate Characteristics – Power Curves

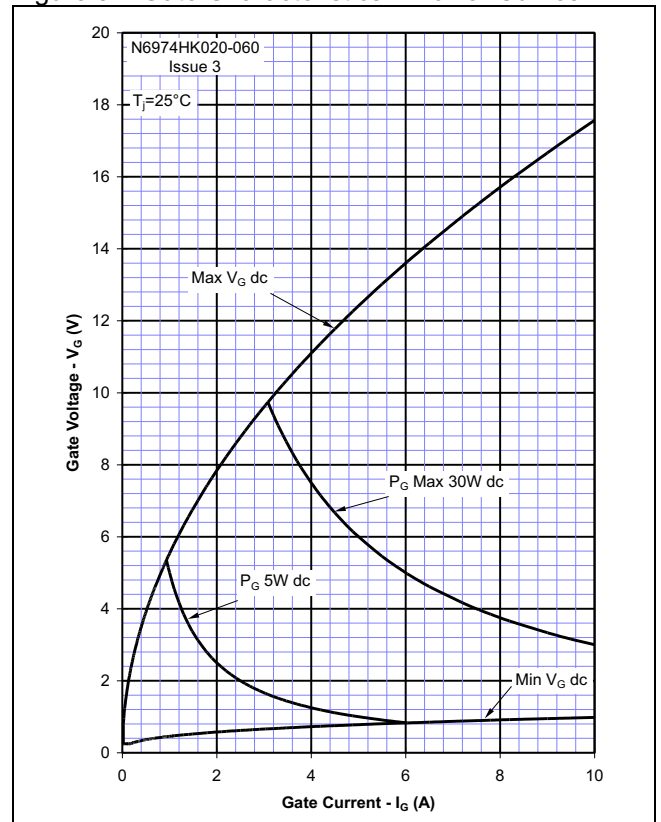

Figure 4 – Total Recovered Charge, Q_{rr}

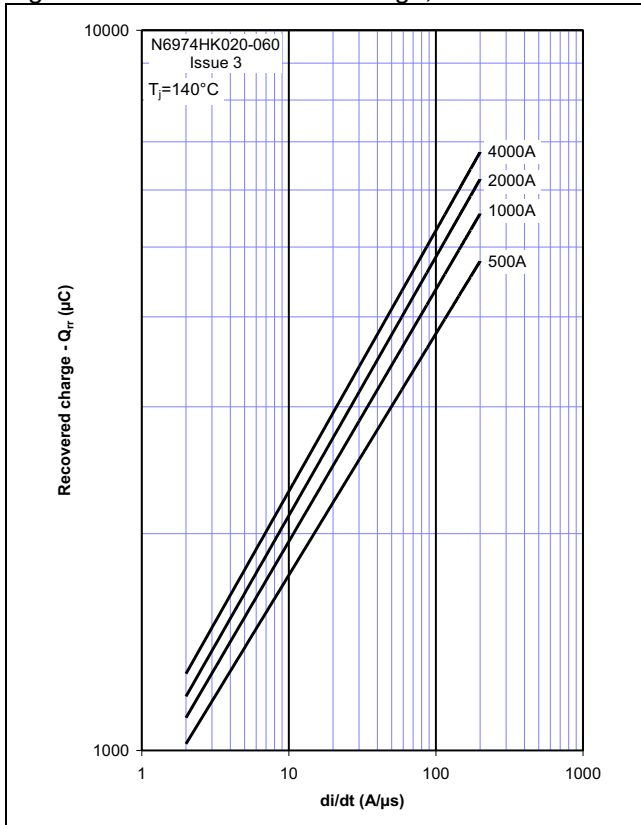

Figure 5 – Recovered Charge, Q_{ra} (50% chord)

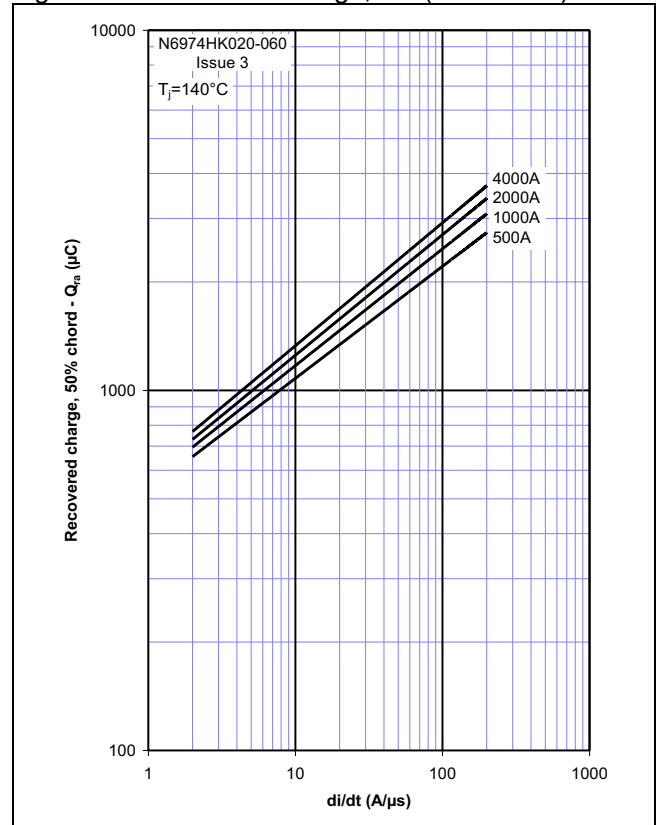

Figure 6 – Peak Reverse Recovery Current, I_{rm}

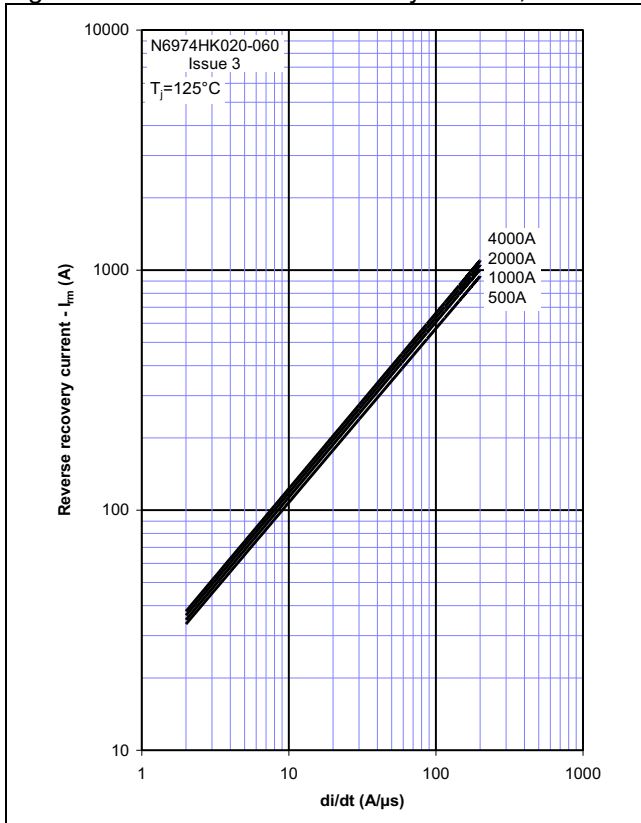

Figure 7 – Maximum Recovery Time, t_{rr} (50% chord)

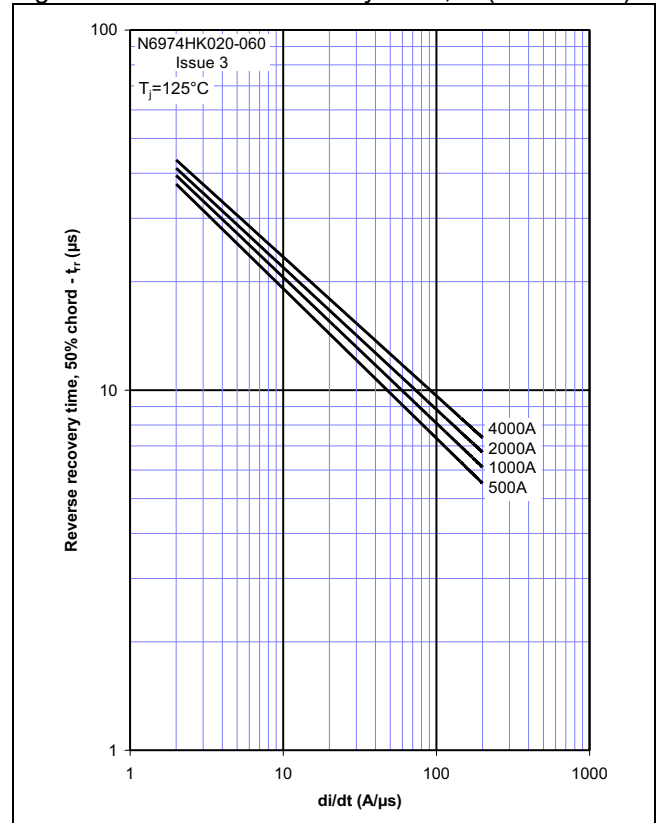

Figure 8 – On-state current vs. Power dissipation – Double Side Cooled (Sine wave)

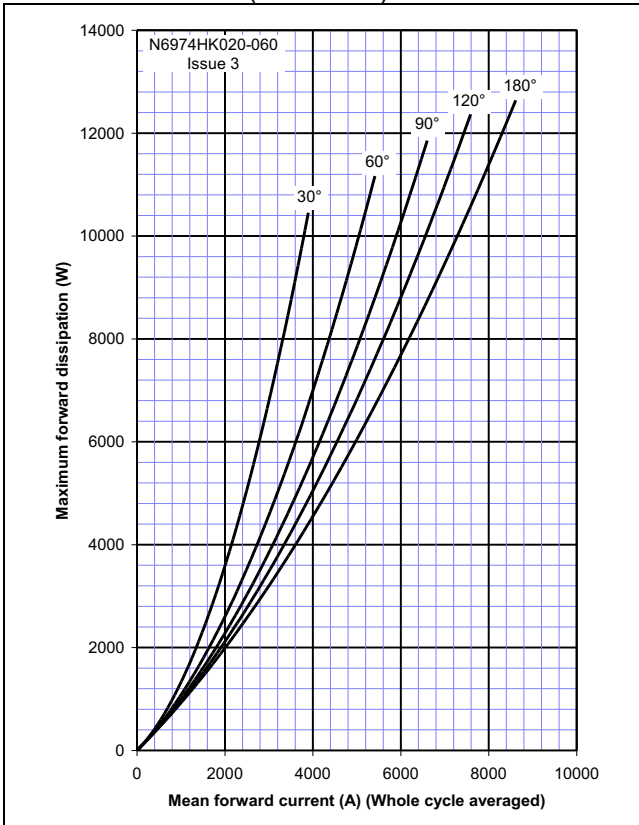

Figure 9 – On-state current vs. Heatsink temperature – Double Side Cooled (Sine wave)

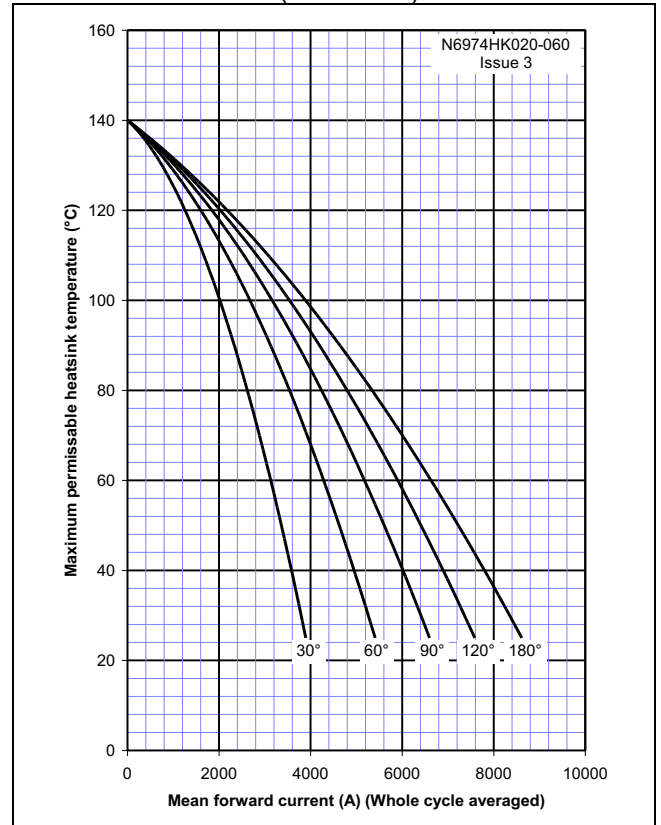

Figure 10 – On-state current vs. Power dissipation – Double Side Cooled (Square wave)

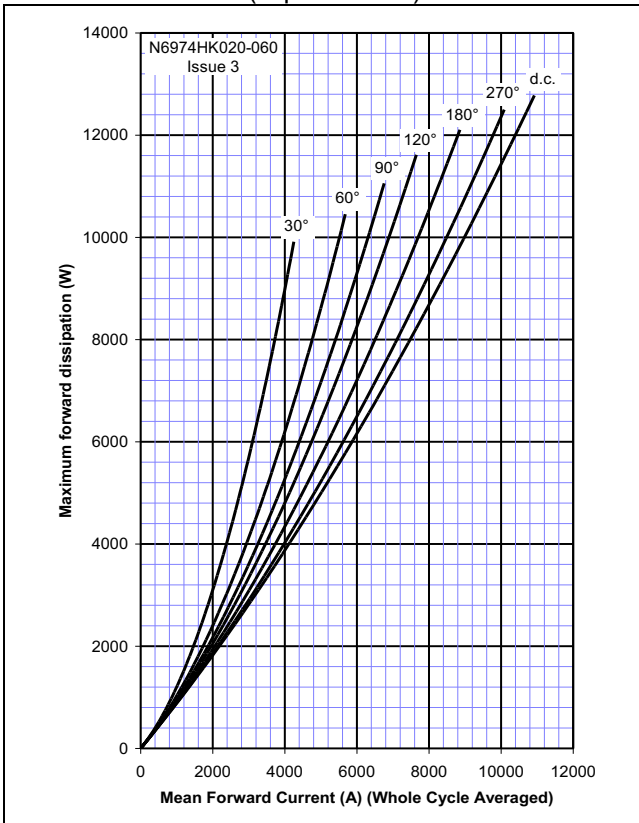

Figure 11 – On-state current vs. Heatsink temperature – Double Side Cooled (Square wave)

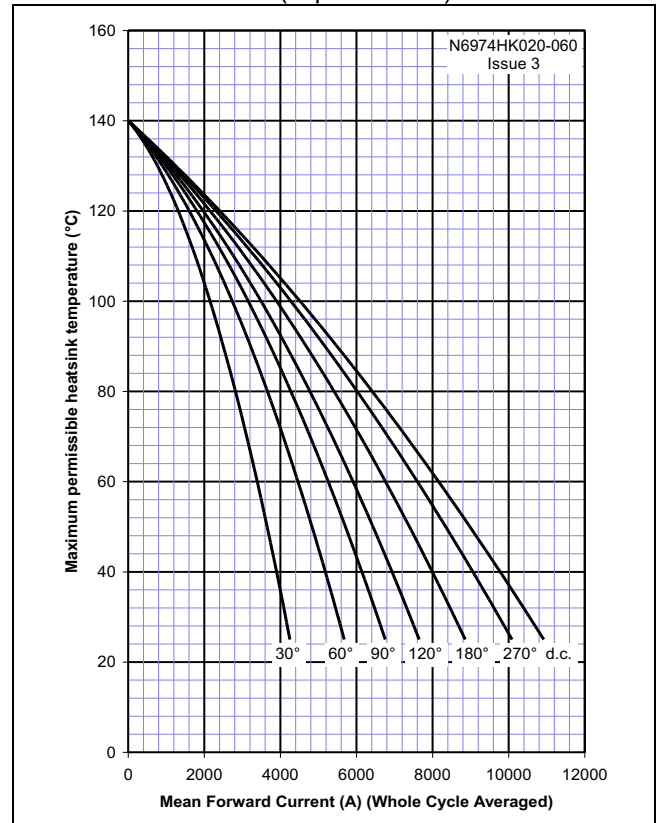

Figure 12 – On-state current vs. Power dissipation – Cathode Side Cooled (Sine wave)

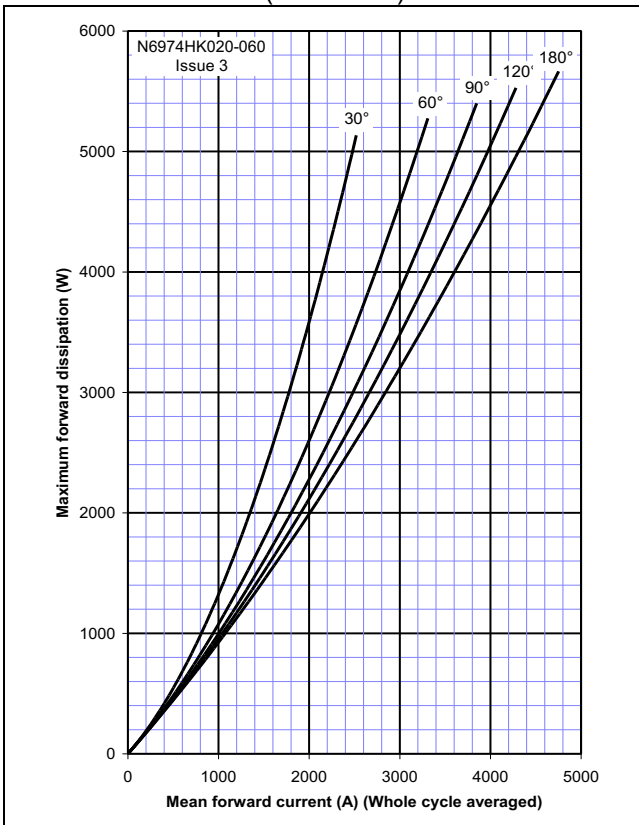

Figure 13 – On-state current vs. Heatsink temperature – Cathode Side Cooled (Sine wave)

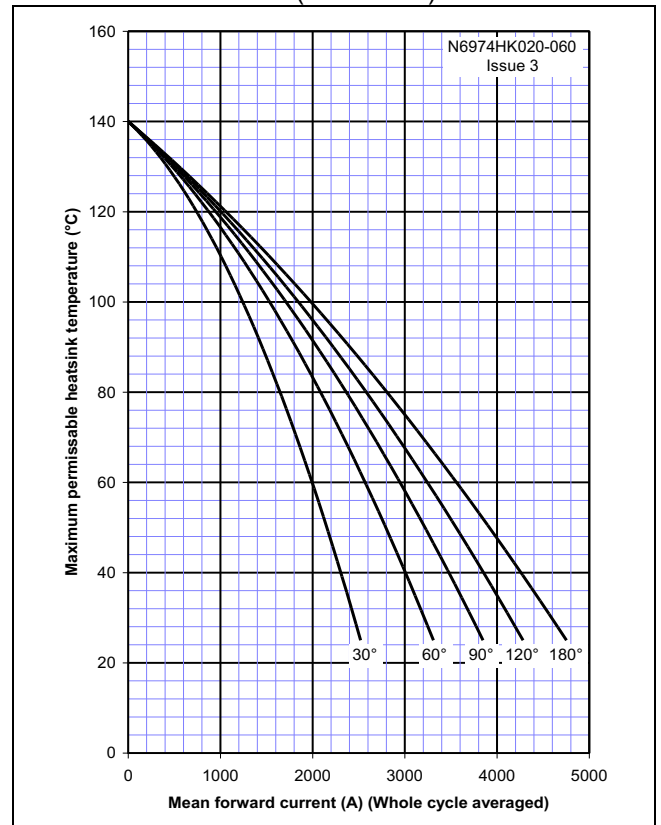

Figure 14 – On-state current vs. Power dissipation – Cathode Side Cooled (Square wave)

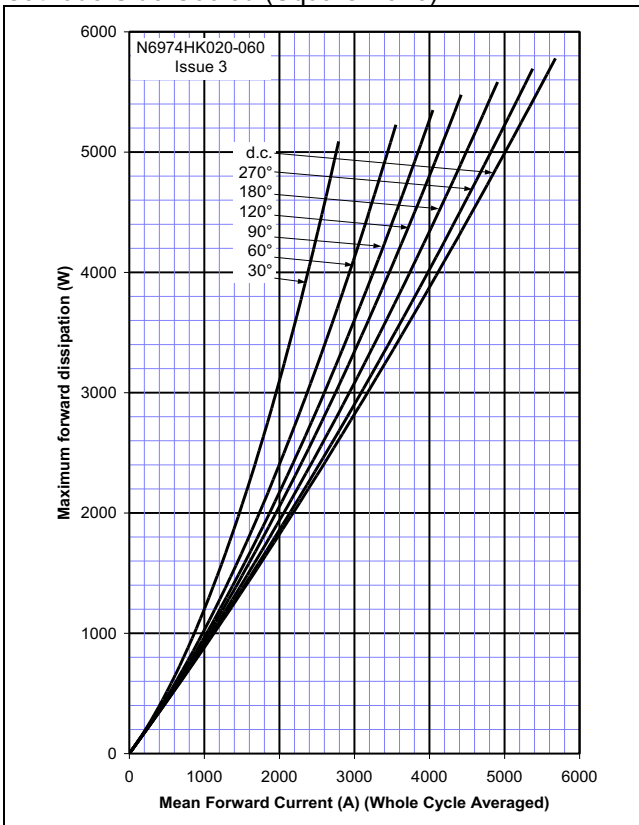

Figure 15 – On-state current vs. Heatsink temperature – Cathode Side Cooled (Square wave)

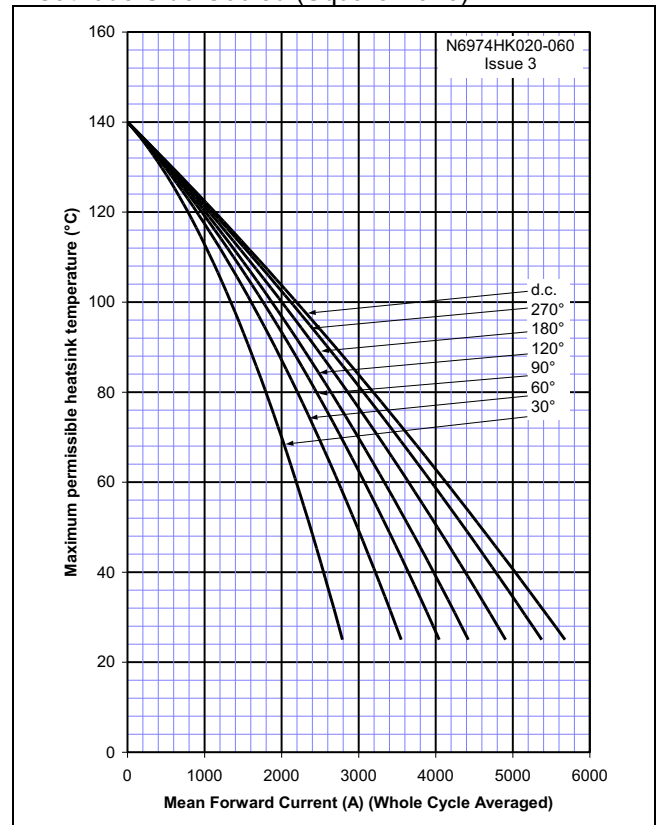

Figure 16 – Maximum surge and I²t Ratings

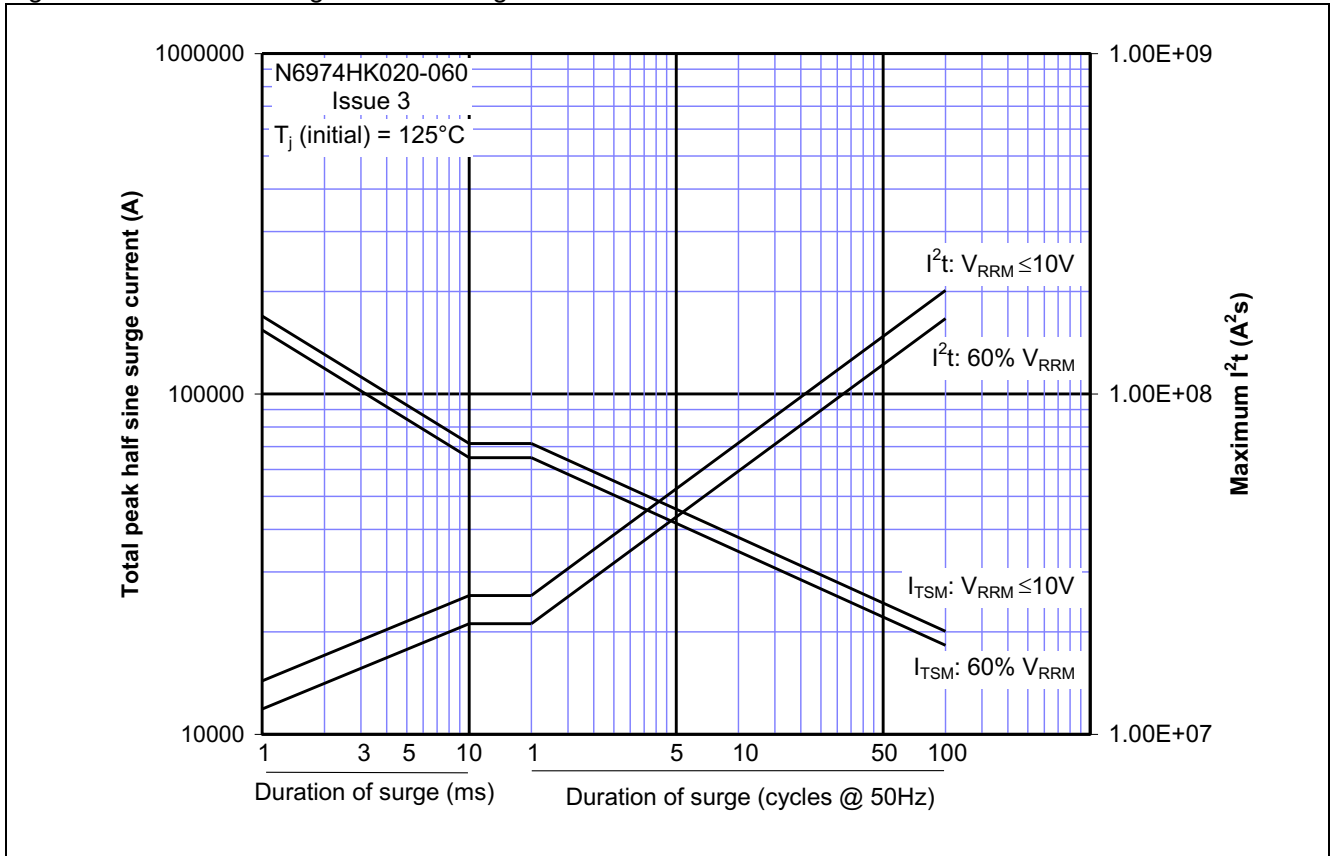
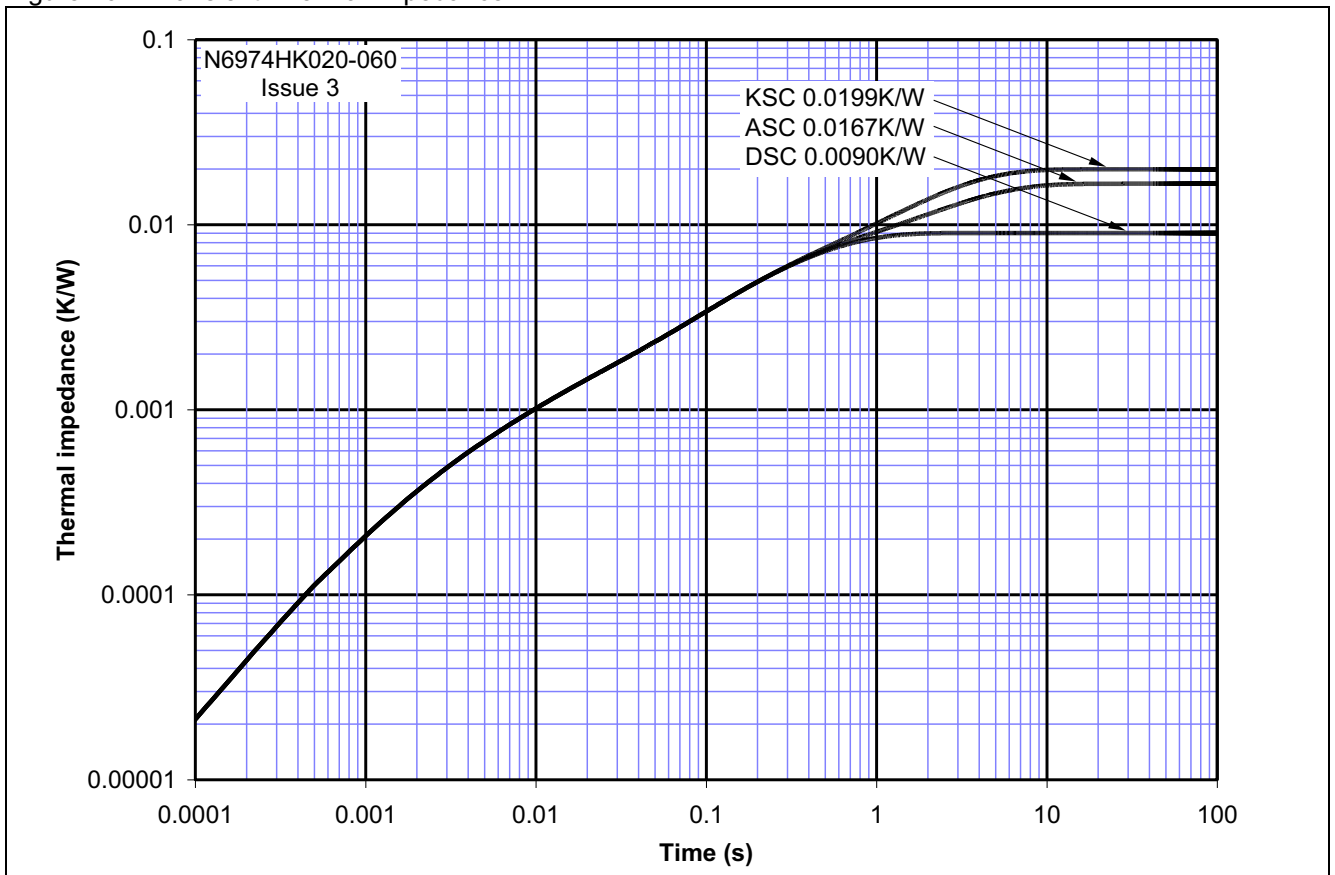
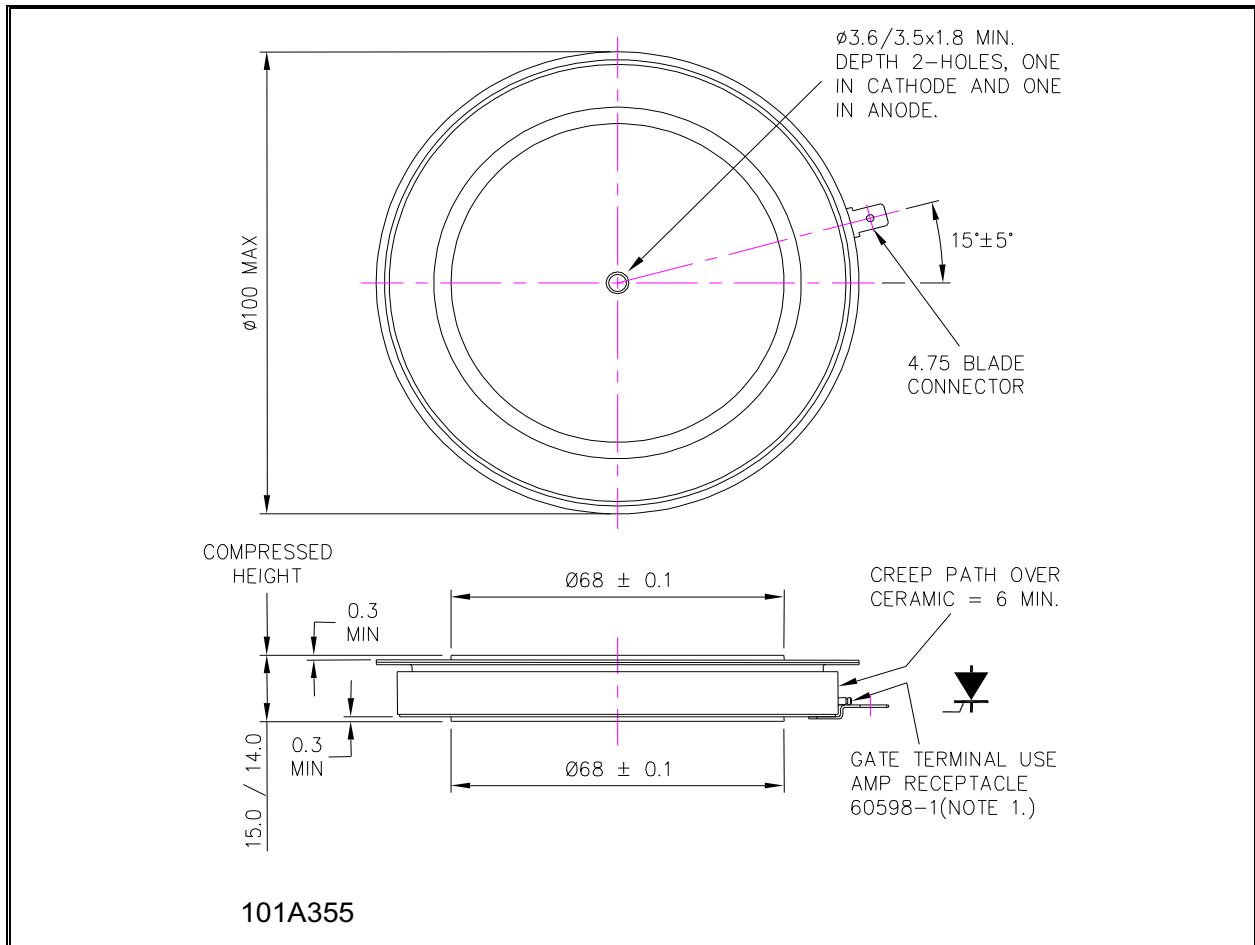

Figure 16 – Transient Thermal Impedance



Outline Drawing & Ordering Information



ORDERING INFORMATION

(Please quote 10 digit code as below)

| | | | |
|-----------------|--------------------|--|--------------------------|
| N6974 | HK | ◆◆ | 0 |
| Fixed Type Code | Fixed outline code | Voltage code $V_{DRM}/100$ 02-06 | Fixed turn-off time code |

Order code: N6974HK040 – 400V V_{DRM} , V_{RRM} , 14mm clamp height capsule.

IXYS Semiconductor GmbH
Edisonstraße 15
D-68623 Lampertheim
Tel: +49 6206 503-0
Fax: +49 6206 503-627
E-mail: marcom@ixys.de



IXYS UK Westcode Ltd
Langley Park Way, Langley Park,
Chippenham, Wiltshire, SN15 1GE.
Tel: +44 (0)1249 444524
Fax: +44 (0)1249 659448
E-mail: sales@ixysuk.com

IXYS Corporation
3540 Bassett Street
Santa Clara CA 95054 USA
Tel: +1 (408) 982 0700
Fax: +1 (408) 496 0670
E-mail: sales@ixys.net

www.ixysuk.com

www.ixys.com

IXYS Long Beach
IXYS Long Beach, Inc
2500 Mira Mar Ave, Long Beach
CA 90815
Tel: +1 (562) 296 6584
Fax: +1 (562) 296 6585
E-mail: service@ixyslongbeach.com

The information contained herein is confidential and is protected by Copyright. The information may not be used or disclosed except with the written permission of and in the manner permitted by the proprietors IXYS UK Westcode Ltd.

© IXYS UK Westcode Ltd.

In the interest of product improvement, IXYS UK Westcode reserves the right to change specifications at any time without prior notice.

Devices with a suffix code (2-letter, 3-letter or letter/digit/letter combination) added to their generic code are not necessarily subject to the conditions and limits contained in this report.



Disclaimer Notice - Information furnished is believed to be accurate and reliable. However, users should independently evaluate the suitability of and test each product selected for their own applications. Littelfuse products are not designed for, and may not be used in, all applications. Read complete Disclaimer Notice at www.littelfuse.com/disclaimer-electronics.