

TrenchP™
Power MOSFET

IXTY26P10T
IXTA26P10T
IXTP26P10T

$V_{DSS} = -100V$
 $I_{D25} = -26A$
 $R_{DS(on)} \leq 90m\Omega$

P-Channel Enhancement Mode
Avalanche Rated

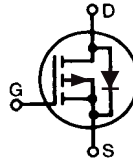

Symbol	Test Conditions	Maximum Ratings	
V_{DSS}	$T_J = 25^\circ C$ to $150^\circ C$	- 100	V
V_{DGR}	$T_J = 25^\circ C$ to $150^\circ C$, $R_{GS} = 1M\Omega$	- 100	V
V_{GSS}	Continuous	± 15	V
V_{GSM}	Transient	± 25	V
I_{D25}	$T_C = 25^\circ C$	- 26	A
I_{DM}	$T_C = 25^\circ C$, Pulse Width Limited by T_{JM}	- 80	A
I_A	$T_C = 25^\circ C$	- 26	A
E_{AS}	$T_C = 25^\circ C$	300	mJ
P_D	$T_C = 25^\circ C$	150	W
T_J		-55 ... +150	$^\circ C$
T_{JM}		150	$^\circ C$
T_{stg}		-55 ... +150	$^\circ C$
T_L	Maximum Lead Temperature for Soldering	300	$^\circ C$
T_{SOLD}	1.6 mm (0.062in.) from Case for 10s	260	$^\circ C$
M_d	Mounting Torque (TO-220)	1.13 / 10	Nm/lb.in
Weight	TO-252	0.35	g
	TO-263	2.50	g
	TO-220	3.00	g

TO-252 (IXTY)

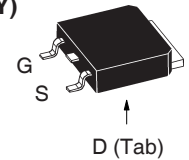

TO-263 (IXTA)

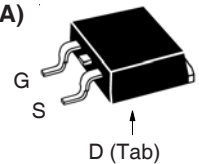

TO-220 (IXTP)

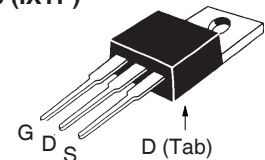

G = Gate D = Drain
S = Source Tab = Drain

Features

- International Standard Packages
- Avalanche Rated
- Extended FBSOA
- Fast Intrinsic Diode
- Low $R_{DS(ON)}$ and Q_G

Advantages

- Easy to Mount
- Space Savings
- High Power Density

Applications

- High-Side Switching
- Push Pull Amplifiers
- DC Choppers
- Automatic Test Equipment
- Current Regulators
- Battery Charger Applications

Symbol	Test Conditions ($T_J = 25^\circ C$, Unless Otherwise Specified)	Characteristic Values		
		Min.	Typ.	Max.
BV_{DSS}	$V_{GS} = 0V$, $I_D = -250\mu A$	-100		V
$V_{GS(th)}$	$V_{DS} = V_{GS}$, $I_D = -250\mu A$	- 2.5		- 4.5 V
I_{GSS}	$V_{GS} = \pm 15V$, $V_{DS} = 0V$			± 50 nA
I_{DSS}	$V_{DS} = V_{DSS}$, $V_{GS} = 0V$ $T_J = 125^\circ C$			-10 μA
				- 250 μA
$R_{DS(on)}$	$V_{GS} = -10V$, $I_D = 0.5 \cdot I_{D25}$, Note 1			90 m Ω

Symbol	Test Conditions ($T_J = 25^\circ\text{C}$, Unless Otherwise Specified)	Characteristic Values		
		Min.	Typ.	Max.
g_{fs}	$V_{DS} = -10\text{V}$, $I_D = 0.5 \cdot I_{D25}$, Note 1	10	17	S
C_{iss}	$V_{GS} = 0\text{V}$, $V_{DS} = -25\text{V}$, $f = 1\text{MHz}$		3820	pF
C_{oss}			280	pF
C_{rss}			93	pF
$t_{d(on)}$	Resistive Switching Times $V_{GS} = -10\text{V}$, $V_{DS} = 0.5 \cdot V_{DSS}$, $I_D = 0.5 \cdot I_{D25}$ $R_G = 3\Omega$ (External)		20	ns
t_r			15	ns
$t_{d(off)}$			37	ns
t_f			11	ns
$Q_{g(on)}$	$V_{GS} = -10\text{V}$, $V_{DS} = 0.5 \cdot V_{DSS}$, $I_D = 0.5 \cdot I_{D25}$		52	nC
Q_{gs}			18	nC
Q_{gd}			16	nC
R_{thJC}	TO-220			0.83 $^\circ\text{C/W}$
R_{thCS}			0.50	$^\circ\text{C/W}$

Source-Drain Diode

Symbol	Test Conditions ($T_J = 25^\circ\text{C}$, Unless Otherwise Specified)	Characteristic Values		
		Min.	Typ.	Max.
I_S	$V_{GS} = 0\text{V}$			-26 A
I_{SM}	Repetitive, Pulse Width Limited by T_{JM}			-104 A
V_{SD}	$I_F = I_S$, $V_{GS} = 0\text{V}$, Note 1			-1.5 V
t_{rr}	$I_F = 0.5 \cdot I_{D25}$, $-di/dt = -100\text{A}/\mu\text{s}$ $V_R = -50\text{V}$, $V_{GS} = 0\text{V}$		70	ns
Q_{RM}			210	nC
I_{RM}			-6	A

Note 1: Pulse test, $t \leq 300\mu\text{s}$, duty cycle, $d \leq 2\%$.

IXYS Reserves the Right to Change Limits, Test Conditions, and Dimensions.

IXYS MOSFETs and IGBTs are covered by one or more of the following U.S. patents:	4,835,592	4,931,844	5,049,961	5,237,481	6,162,665	6,404,065B1	6,683,344	6,727,585	7,005,734B2	7,157,338B2
	4,860,072	5,017,508	5,063,307	5,381,025	6,259,123B1	6,534,343	6,710,405B2	6,759,692	7,063,975B2	
	4,881,106	5,034,796	5,187,117	5,486,715	6,306,728B1	6,583,505	6,710,463	6,771,478B2	7,071,537	

Fig. 1. Output Characteristics @ $T_J = 25^\circ\text{C}$

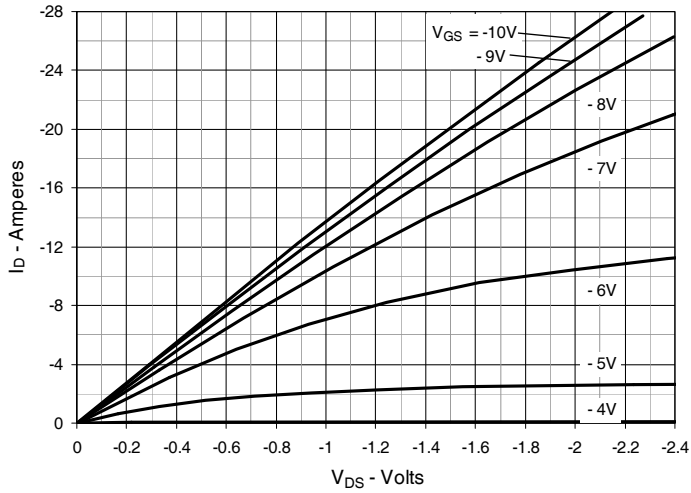

Fig. 2. Extended Output Characteristics @ $T_J = 25^\circ\text{C}$

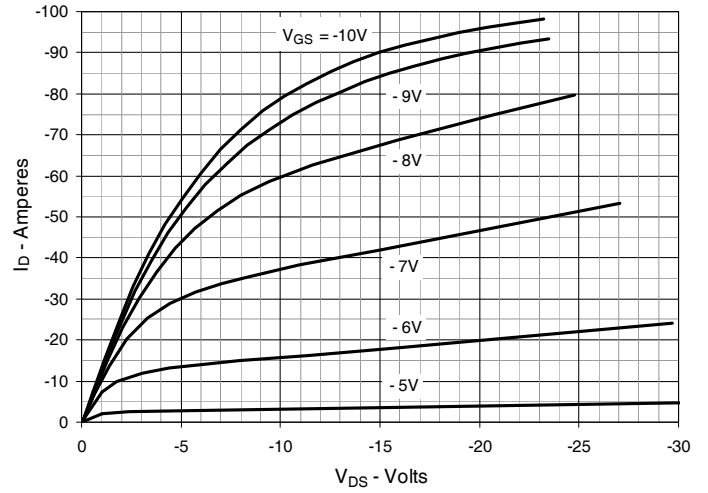

Fig. 3. Output Characteristics @ $T_J = 125^\circ\text{C}$

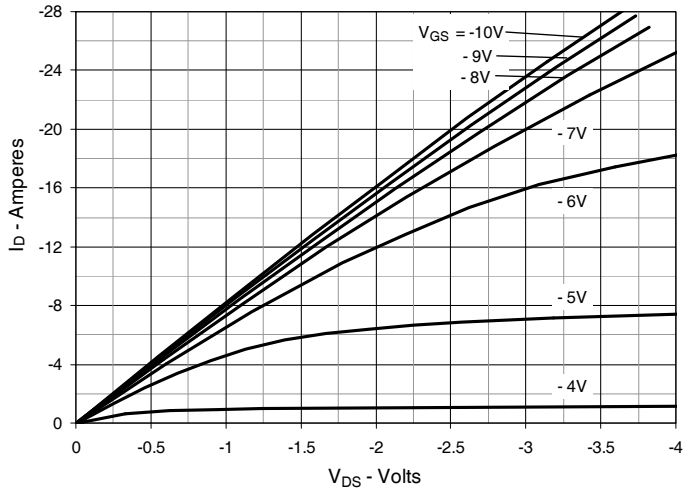

Fig. 4. $R_{DS(on)}$ Normalized to $I_D = -13\text{A}$ Value vs. Junction Temperature

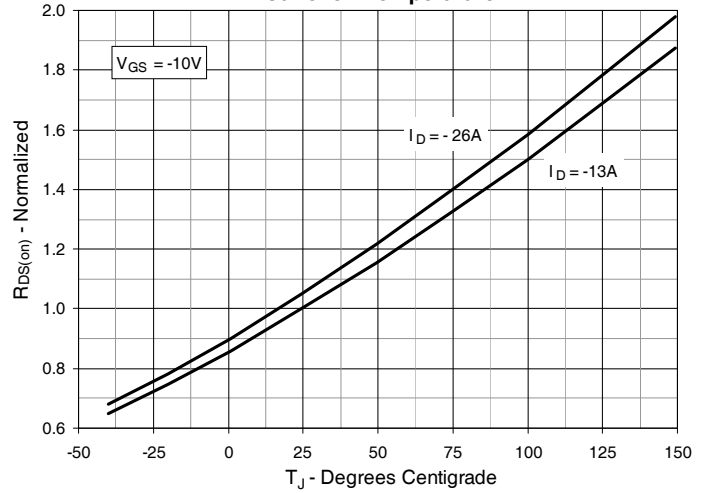

Fig. 5. $R_{DS(on)}$ Normalized to $I_D = -13\text{A}$ Value vs. Drain Current

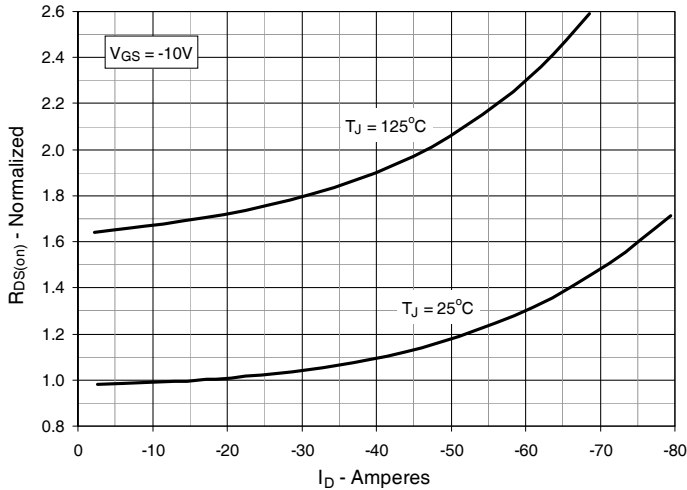

Fig. 6. Maximum Drain Current vs. Case Temperature

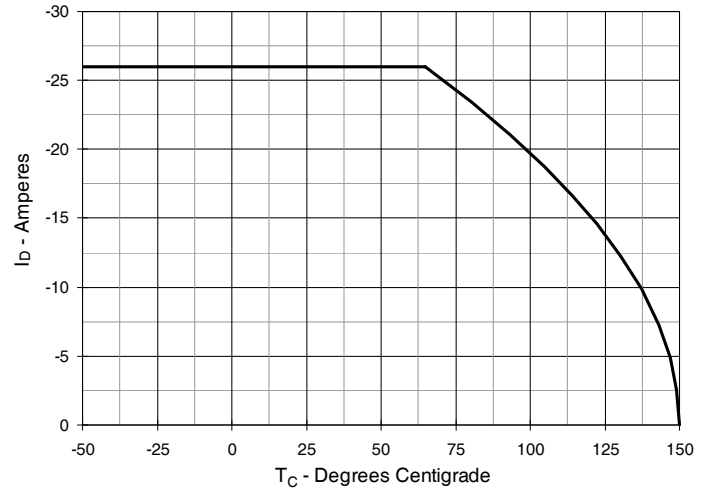

Fig. 7. Input Admittance

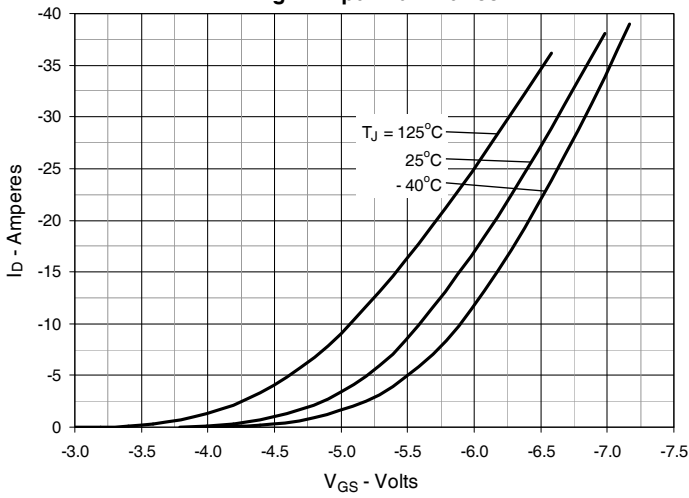

Fig. 8. Transconductance

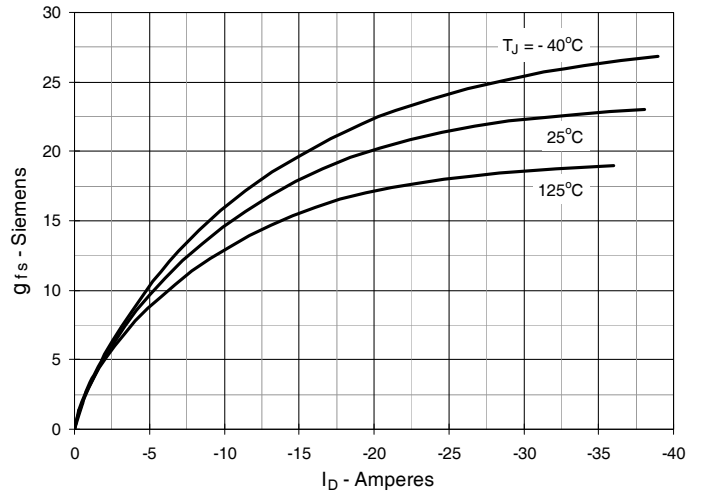

Fig. 9. Forward Voltage Drop of Intrinsic Diode

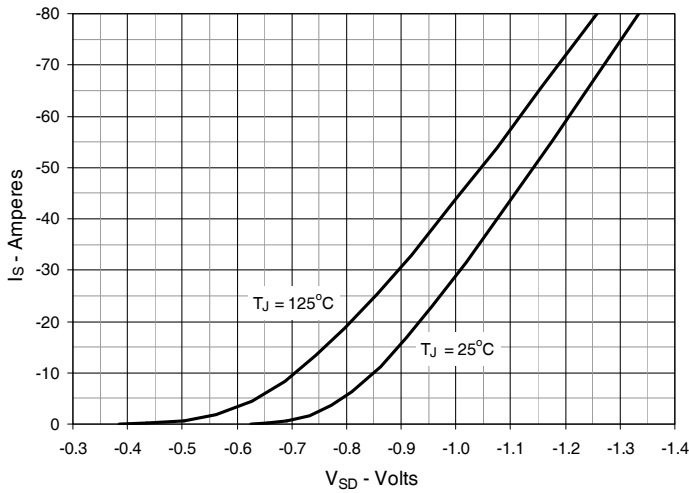

Fig. 10. Gate Charge

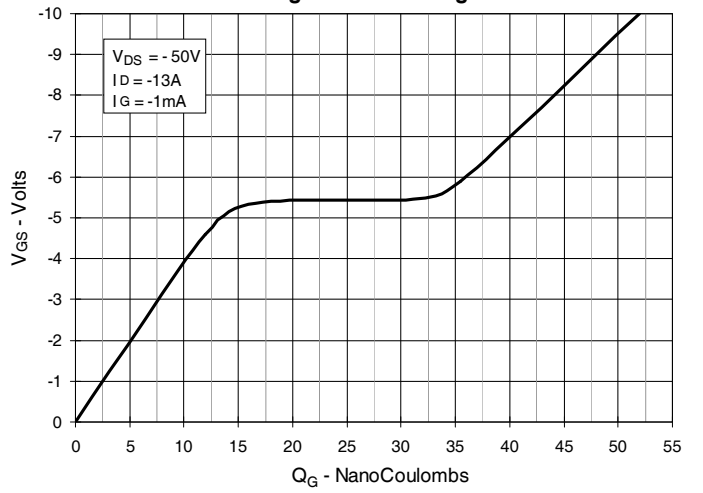

Fig. 11. Capacitance

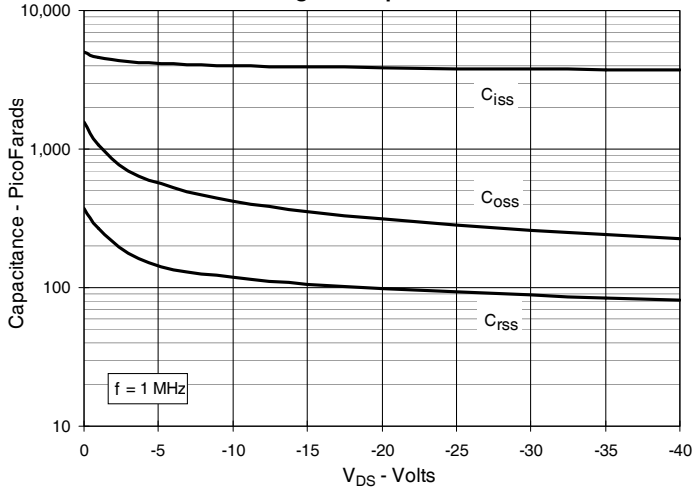

Fig. 12. Forward-Bias Safe Operating Area

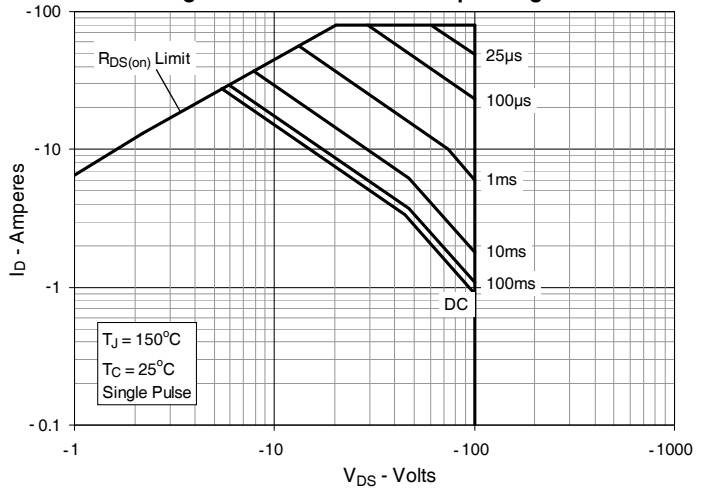

Fig. 13. Resistive Turn-on Rise Time vs. Junction Temperature

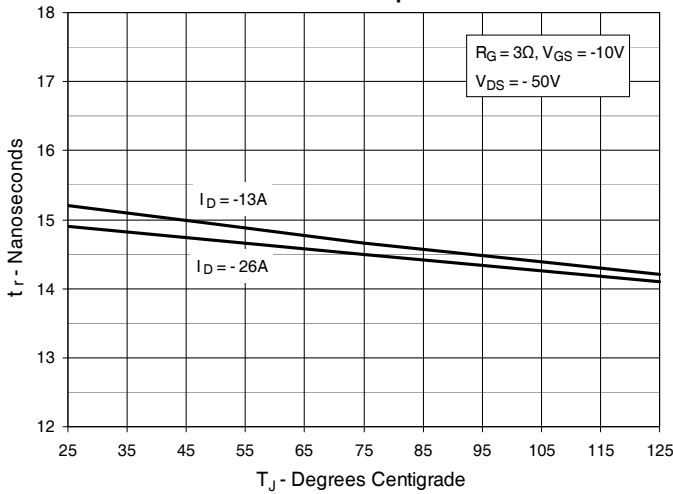

Fig. 14. Resistive Turn-on Rise Time vs. Drain Current

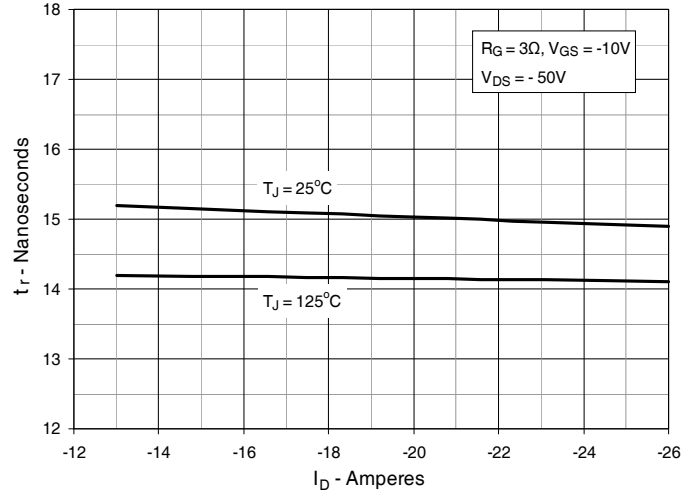

Fig. 15. Resistive Turn-on Switching Times vs. Gate Resistance

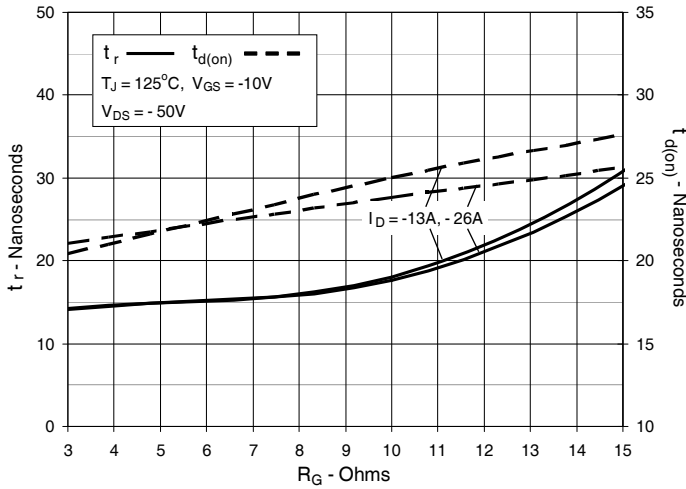

Fig. 16. Resistive Turn-off Switching Times vs. Junction Temperature

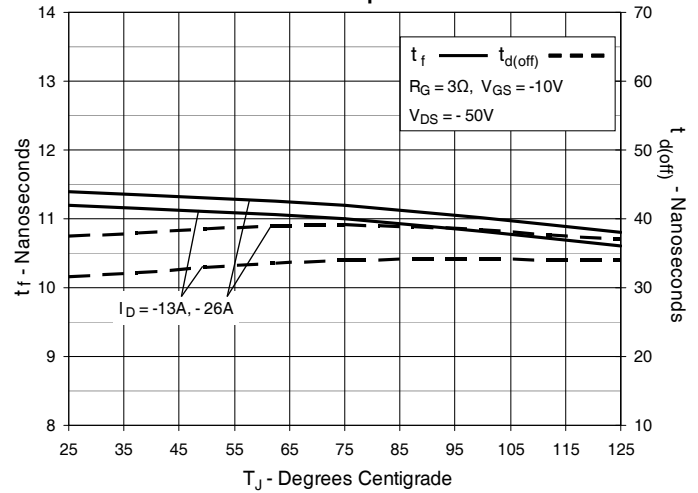

Fig. 17. Resistive Turn-off Switching Times vs. Drain Current

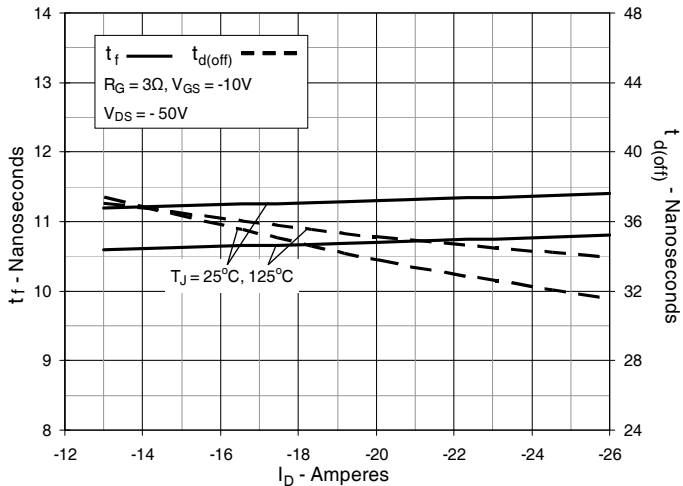

Fig. 18. Resistive Turn-off Switching Times vs. Gate Resistance

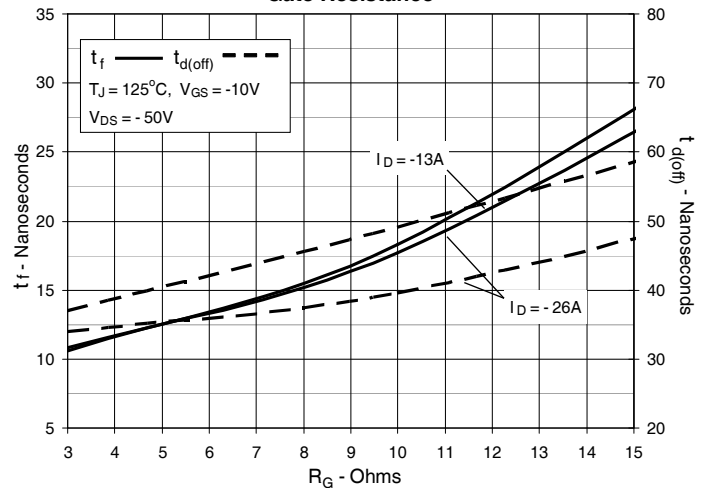
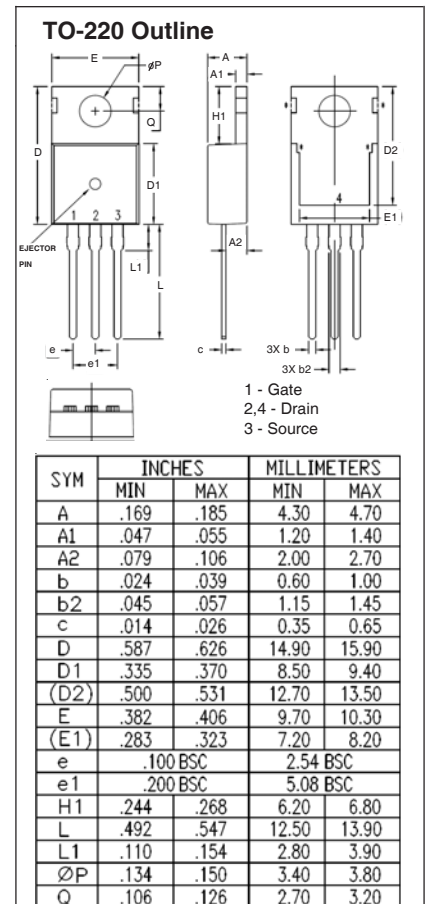
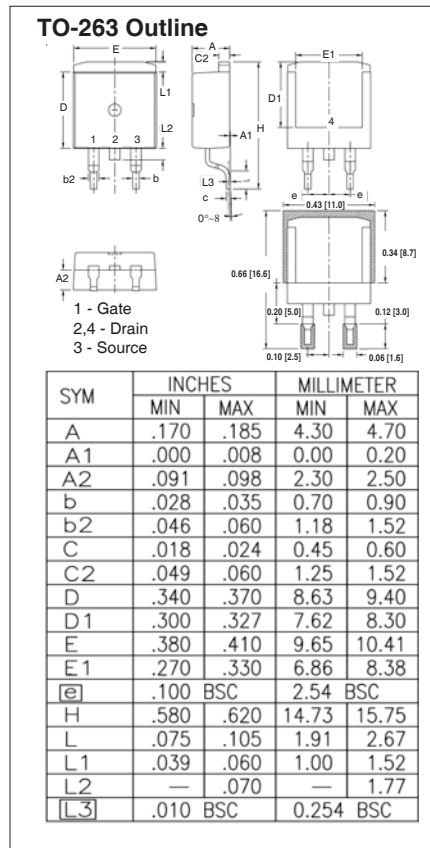
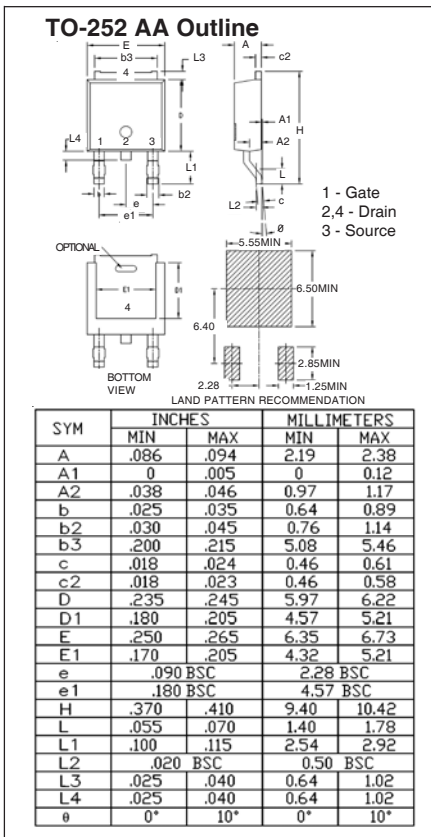
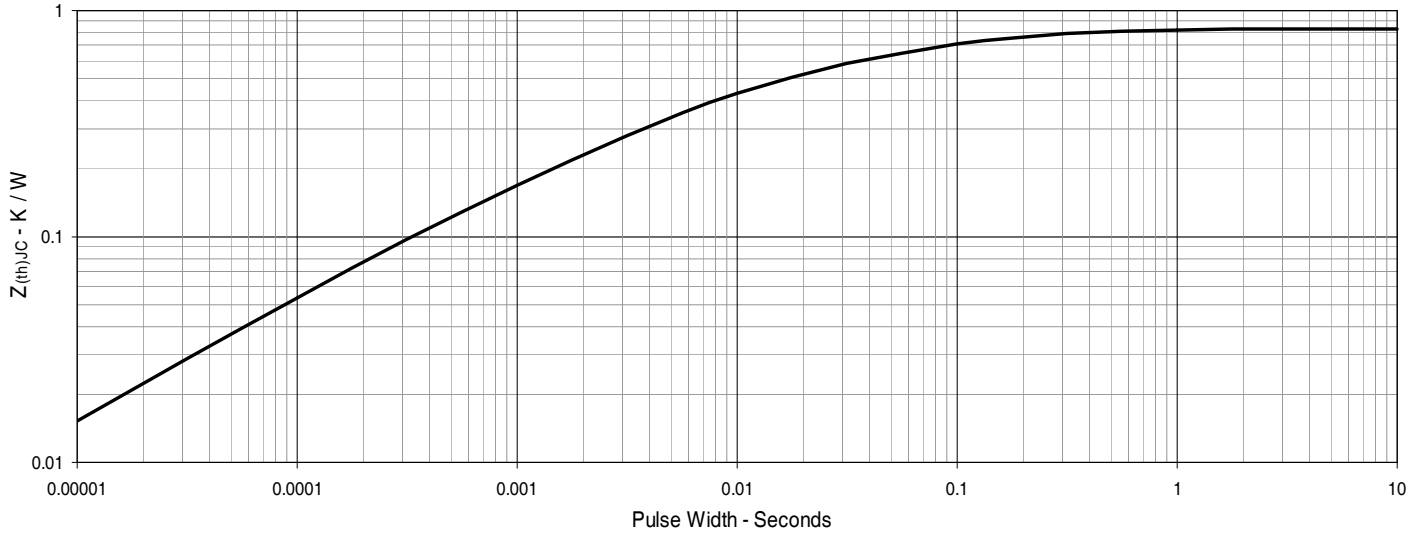

Fig. 19. Maximum Transient Thermal Impedance





Disclaimer Notice - Information furnished is believed to be accurate and reliable. However, users should independently evaluate the suitability of and test each product selected for their own applications. Littelfuse products are not designed for, and may not be used in, all applications. Read complete Disclaimer Notice at www.littelfuse.com/disclaimer-electronics.