

**TrenchP™  
Power MOSFETs**
**IXTK210P10T  
IXTX210P10T**

P-Channel Enhancement Mode  
Avalanche Rated  
Fast Intrinsic Rectifier

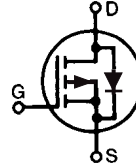

$$\begin{aligned}
 V_{DSS} &= -100V \\
 I_{D25} &= -210A \\
 R_{DS(on)} &\leq 7.5m\Omega \\
 t_{rr} &\leq 200ns
 \end{aligned}$$

Symbol	Test Conditions	Maximum Ratings	
$V_{DSS}$	$T_J = 25^\circ\text{C}$ to $150^\circ\text{C}$	-100	V
$V_{DGR}$	$T_J = 25^\circ\text{C}$ to $150^\circ\text{C}$ , $R_{GS} = 1M\Omega$	-100	V
$V_{GSS}$	Continuous	$\pm 15$	V
$V_{GSM}$	Transient	$\pm 25$	V
$I_{D25}$	$T_C = 25^\circ\text{C}$ (Chip Capability)	- 210	A
$I_{LRMS}$	Lead Current Limit, RMS	-160	A
$I_{DM}$	$T_C = 25^\circ\text{C}$ , Pulse Width Limited by $T_{JM}$	- 800	A
$I_A$	$T_C = 25^\circ\text{C}$	-100	A
$E_{AS}$	$T_C = 25^\circ\text{C}$	3	J
$dv/dt$	$I_S \leq I_{DM}$ , $V_{DD} \leq V_{DSS}$ , $T_J \leq 150^\circ\text{C}$	10	V/ns
$P_D$	$T_C = 25^\circ\text{C}$	1040	W
$T_J$		-55 ... +150	$^\circ\text{C}$
$T_{JM}$		150	$^\circ\text{C}$
$T_{stg}$		-55 ... +150	$^\circ\text{C}$
$T_L$	1.6mm (0.062 in.) from Case for 10s	300	$^\circ\text{C}$
$T_{SOLD}$	Plastic Body for 10s	260	$^\circ\text{C}$
$M_d$	Mounting Torque (TO-264)	1.13/10	Nm/lb.in.
$F_c$	Mounting Force (PLUS247)	20..120 /4.5..27	N/lb.
<b>Weight</b>	TO-264	10	g
	PLUS247	6	g

TO-264 (IXTK)

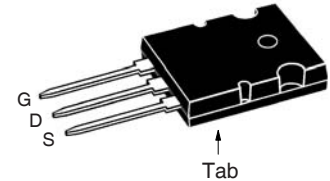

PLUS247 (IXTX)

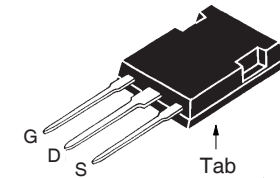

G = Gate      D = Drain  
S = Source      Tab = Drain

**Features**

- International Standard Packages
- High Current Handling Capability
- Avalanche Rated
- Extended FBSOA
- Fast Intrinsic Rectifier
- Low  $R_{DS(ON)}$  and  $Q_G$

**Advantages**

- Easy to Mount
- Space Savings
- High Power Density

**Applications**

- High-Side Switching
- Push Pull Amplifiers
- DC Choppers
- Automatic Test Equipment
- Current Regulators
- Battery Charger Applications

Symbol	Test Conditions ( $T_J = 25^\circ\text{C}$ Unless Otherwise Specified)	Characteristic Values		
		Min.	Typ.	Max.
$BV_{DSS}$	$V_{GS} = 0V$ , $I_D = -250\mu A$	-100		V
$V_{GS(th)}$	$V_{DS} = V_{GS}$ , $I_D = -250\mu A$	- 2.5		- 4.5 V
$I_{GSS}$	$V_{GS} = \pm 15V$ , $V_{DS} = 0V$			$\pm 200$ nA
$I_{DSS}$	$V_{DS} = V_{DSS}$ , $V_{GS} = 0V$ $T_J = 125^\circ\text{C}$			- 25 $\mu A$ - 300 $\mu A$
$R_{DS(on)}$	$V_{GS} = -10V$ , $I_D = 0.5 \cdot I_{D25}$ , Note 1			7.5 m $\Omega$

Symbol	Test Conditions ( $T_J = 25^\circ\text{C}$ Unless Otherwise Specified)	Characteristic Values		
		Min.	Typ.	Max.
$g_{fs}$	$V_{DS} = -10\text{V}, I_D = -60\text{A}$ , Note 1	90	150	S
$C_{iss}$	$V_{GS} = 0\text{V}, V_{DS} = -25\text{V}, f = 1\text{MHz}$		69.5	nF
$C_{oss}$			4070	pF
$C_{rss}$			1100	pF
$t_{d(on)}$	<b>Resistive Switching Times</b> $V_{GS} = -10\text{V}, V_{DS} = 0.5 \cdot V_{DSS}, I_D = 0.5 \cdot I_{D25}$ $R_G = 1\Omega$ (External)		90	ns
$t_r$			98	ns
$t_{d(off)}$			165	ns
$t_f$			55	ns
$Q_{g(on)}$	$V_{GS} = -10\text{V}, V_{DS} = 0.5 \cdot V_{DSS}, I_D = 0.5 \cdot I_{D25}$		740	nC
$Q_{gs}$			200	nC
$Q_{gd}$			155	nC
$R_{thJC}$			0.12	$^\circ\text{C/W}$
$R_{thCS}$		0.15		$^\circ\text{C/W}$

### Source-Drain Diode

Symbol	Test Conditions ( $T_J = 25^\circ\text{C}$ Unless Otherwise Specified)	Characteristic Values		
		Min.	Typ.	Max.
$I_S$	$V_{GS} = 0\text{V}$			- 210 A
$I_{SM}$	Repetitive, Pulse Width Limited by $T_{JM}$			- 840 A
$V_{SD}$	$I_F = -100\text{A}, V_{GS} = 0\text{V}$ , Note 1			-1.4 V
$t_{rr}$	$I_F = -105\text{A}, -di/dt = -100\text{A}/\mu\text{s}$ $V_R = -100\text{V}, V_{GS} = 0\text{V}$			200 ns
$Q_{RM}$			930	nC
$I_{RM}$			12.4	A

Note 1. Pulse test,  $t \leq 300\mu\text{s}$ , duty cycle,  $d \leq 2\%$ .

### PRELIMINARY TECHNICAL INFORMATION

The product presented herein is under development. The Technical Specifications offered are derived from data gathered during objective characterizations of preliminary engineering lots; but also may yet contain some information supplied during a pre-production design evaluation. IXYS reserves the right to change limits, test conditions, and dimensions without notice.

IXYS Reserves the Right to Change Limits, Test Conditions, and Dimensions.

IXYS MOSFETs and IGBTs are covered by one or more of the following U.S. patents:

4,835,592	4,931,844	5,049,961	5,237,481	6,162,665	6,404,065 B1	6,683,344	6,727,585	7,005,734 B2	7,157,338B2
4,860,072	5,017,508	5,063,307	5,381,025	6,259,123 B1	6,534,343	6,710,405 B2	6,759,692	7,063,975 B2	
4,881,106	5,034,796	5,187,117	5,486,715	6,306,728 B1	6,583,505	6,710,463	6,771,478 B2	7,071,537	

### TO-264 AA Outline

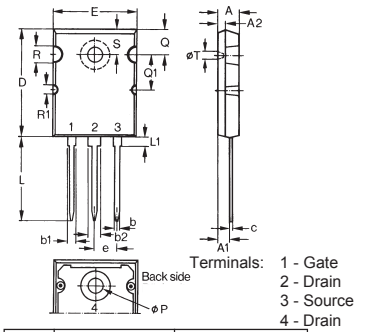

Dim.	Millimeter		Inches	
	Min.	Max.	Min.	Max.
A	4.82	5.13	.190	.202
A1	2.54	2.89	.100	.114
A2	2.00	2.10	.079	.083
b	1.12	1.42	.044	.056
b1	2.39	2.69	.094	.106
b2	2.90	3.09	.114	.122
c	0.53	0.83	.021	.033
D	25.91	26.16	1.020	1.030
E	19.81	19.96	.780	.786
e	5.46 BSC		.215 BSC	
J	0.00	0.25	.000	.010
K	0.00	0.25	.000	.010
L	20.32	20.83	.800	.820
L1	2.29	2.59	.090	.102
P	3.17	3.66	.125	.144
Q	6.07	6.27	.239	.247
Q1	8.38	8.69	.330	.342
R	3.81	4.32	.150	.170
R1	1.78	2.29	.070	.090
S	6.04	6.30	.238	.248
T	1.57	1.83	.062	.072

### PLUS247™ Outline

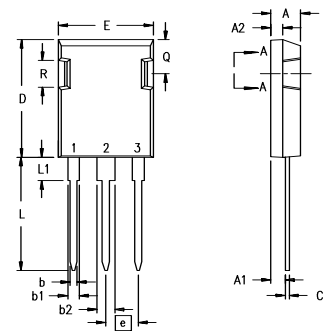

Terminals: 1 - Gate  
2 - Drain  
3 - Source

Dim.	Millimeter		Inches	
	Min.	Max.	Min.	Max.
A	4.83	5.21	.190	.205
A <sub>1</sub>	2.29	2.54	.090	.100
A <sub>2</sub>	1.91	2.16	.075	.085
b	1.14	1.40	.045	.055
b <sub>1</sub>	1.91	2.13	.075	.084
b <sub>2</sub>	2.92	3.12	.115	.123
C	0.61	0.80	.024	.031
D	20.80	21.34	.819	.840
E	15.75	16.13	.620	.635
e	5.45 BSC		.215 BSC	
L	19.81	20.32	.780	.800
L1	3.81	4.32	.150	.170
Q	5.59	6.20	.220	0.244
R	4.32	4.83	.170	.190

**Fig. 1. Output Characteristics @  $T_J = 25^\circ\text{C}$**

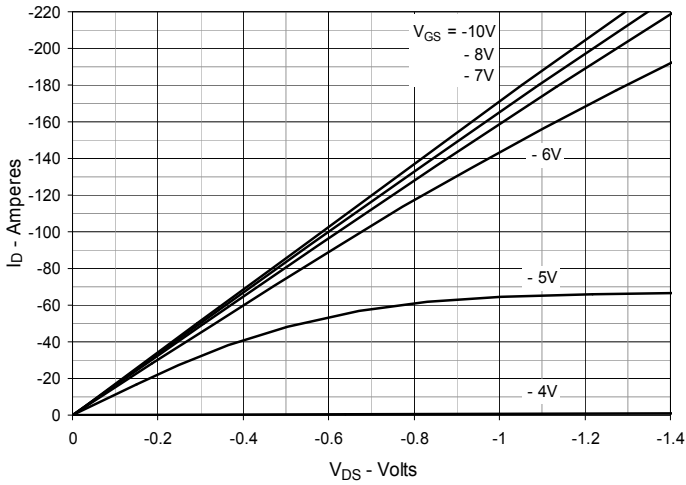

**Fig. 2. Extended Output Characteristics @  $T_J = 25^\circ\text{C}$**

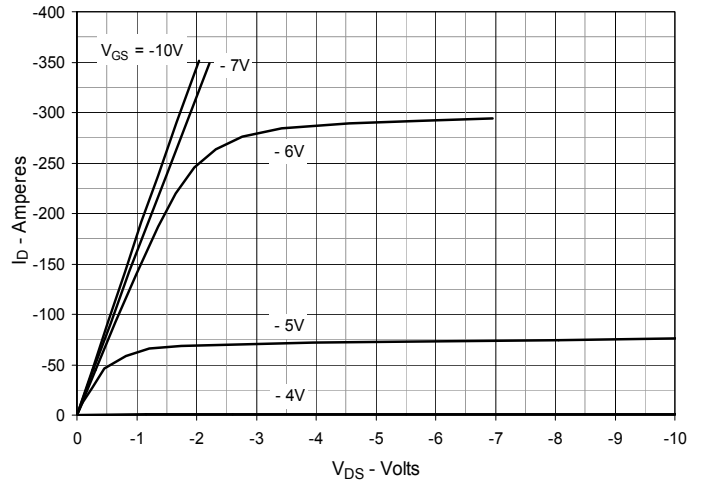

**Fig. 3. Output Characteristics @  $T_J = 125^\circ\text{C}$**

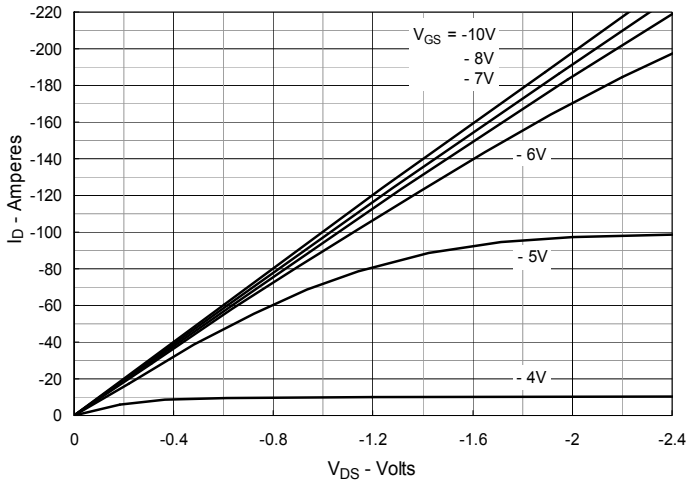

**Fig. 4.  $R_{DS(on)}$  Normalized to  $I_D = -105\text{A}$  Value vs. Junction Temperature**

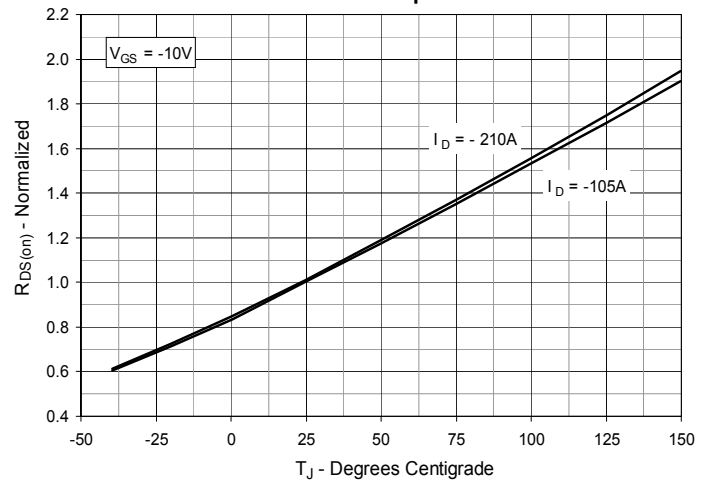

**Fig. 5.  $R_{DS(on)}$  Normalized to  $I_D = -105\text{A}$  Value vs. Drain Current**

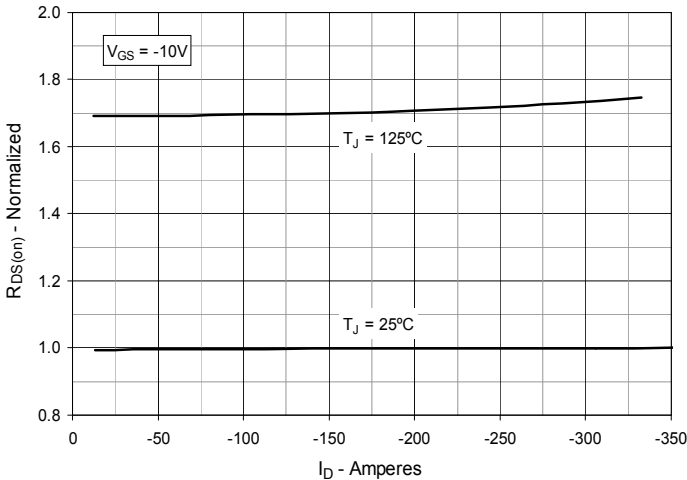

**Fig. 6. Maximum Drain Current vs. Case Temperature**

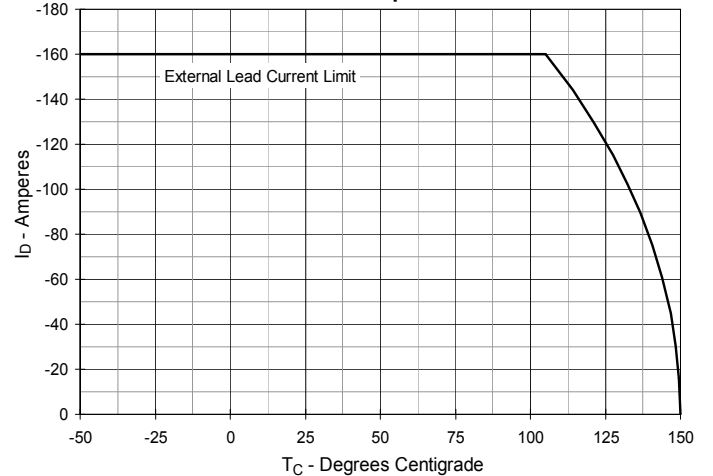

**Fig. 7. Input Admittance**

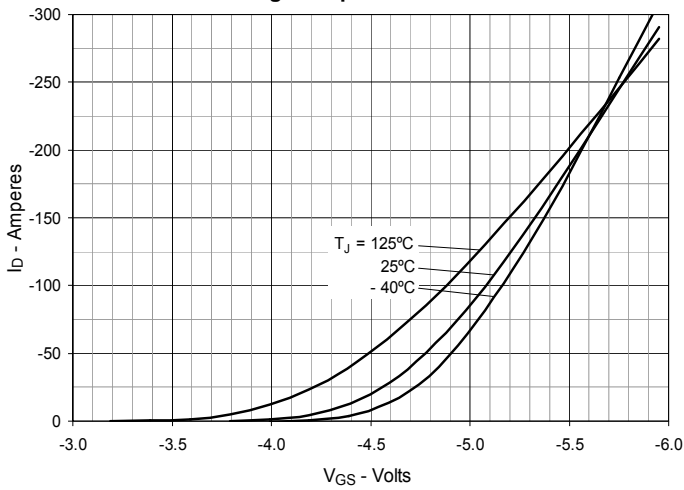

**Fig. 8. Transconductance**

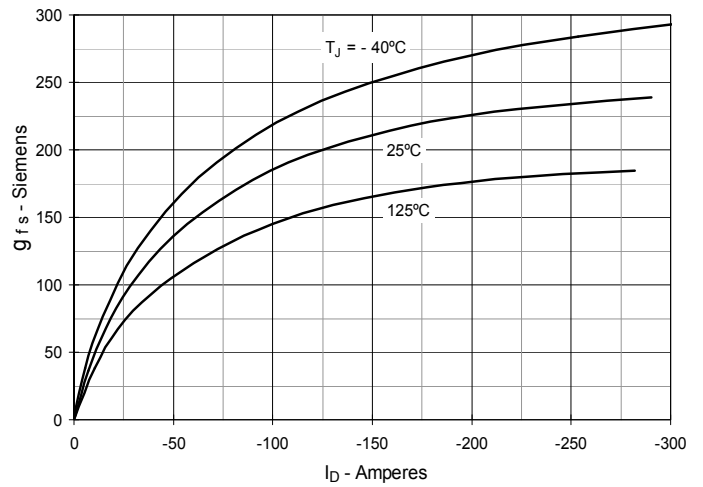

**Fig. 9. Forward Voltage Drop of Intrinsic Diode**

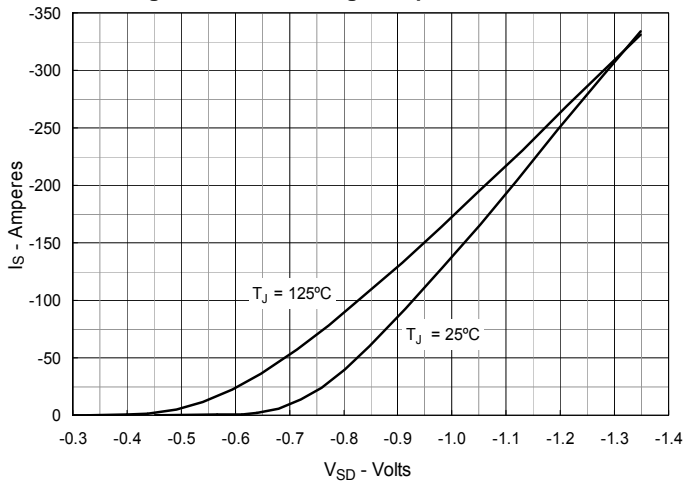

**Fig. 10. Gate Charge**

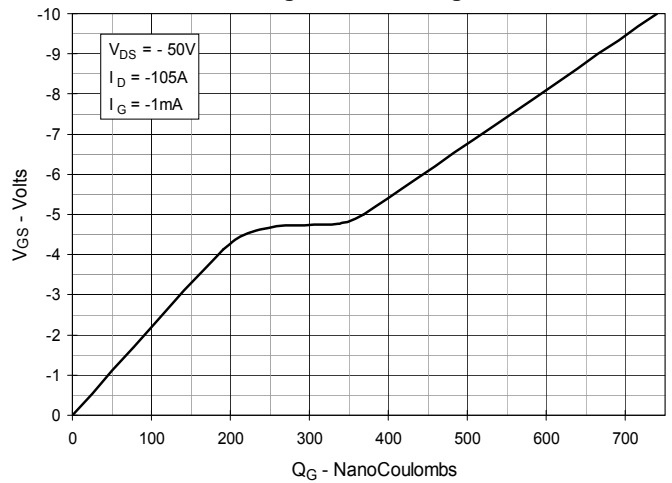

**Fig. 11. Capacitance**

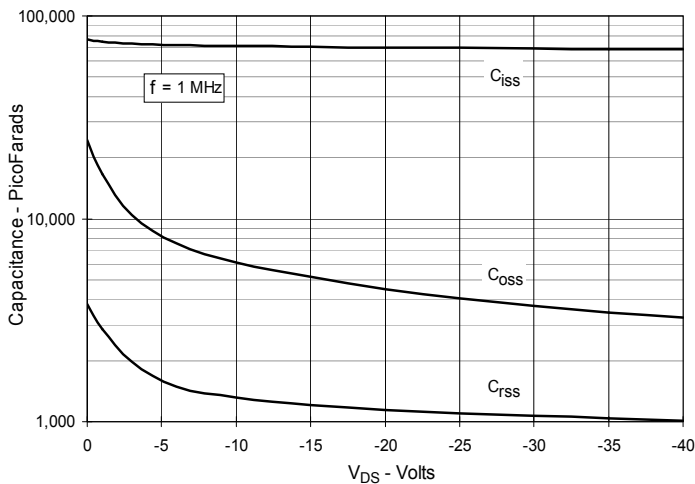

**Fig. 12. Forward-Bias Safe Operating Area**

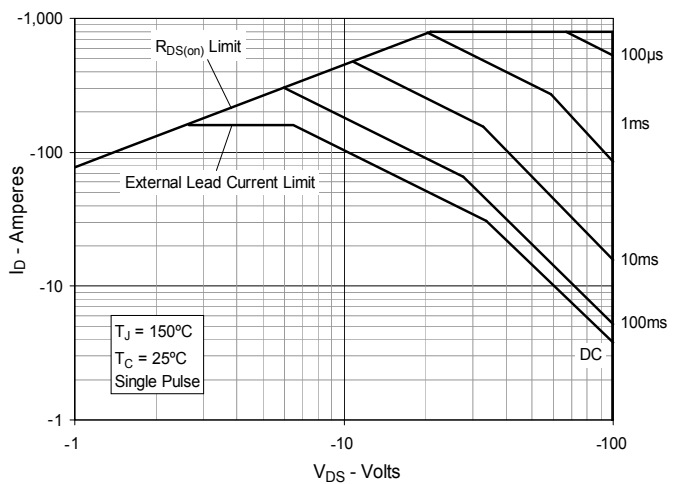

**Fig. 13. Resistive Turn-on Rise Time vs. Junction Temperature**

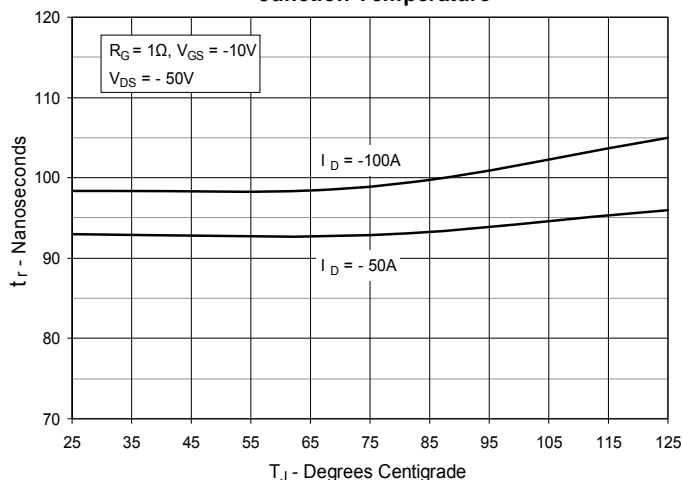

**Fig. 14. Resistive Turn-on Rise Time vs. Drain Current**

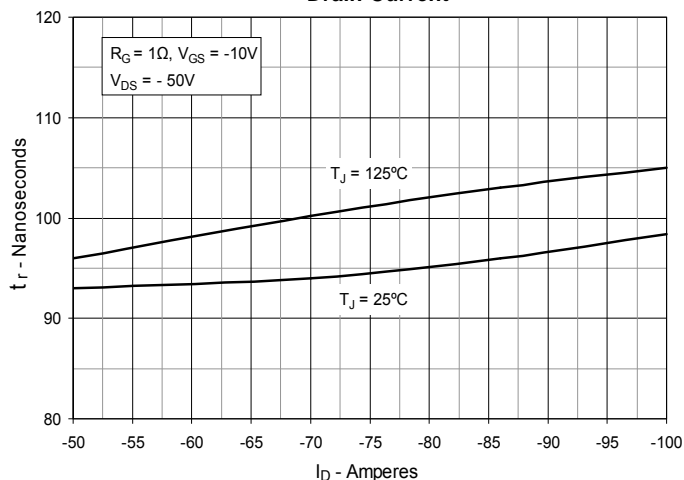

**Fig. 15. Resistive Turn-on Switching Times vs. Gate Resistance**

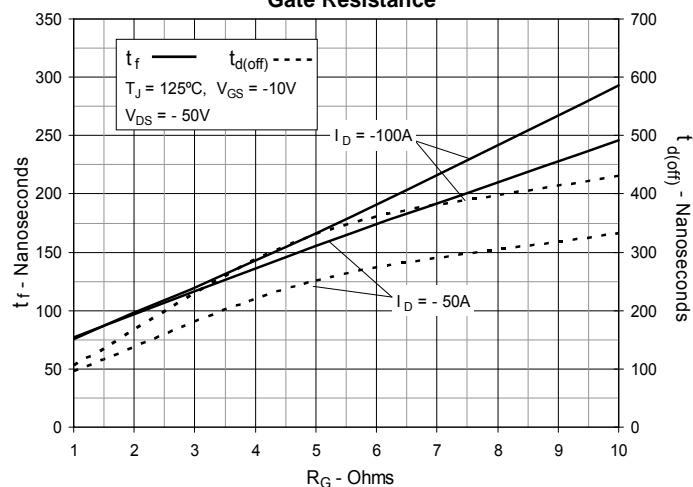

**Fig. 16. Resistive Turn-off Switching Times vs. Junction Temperature**

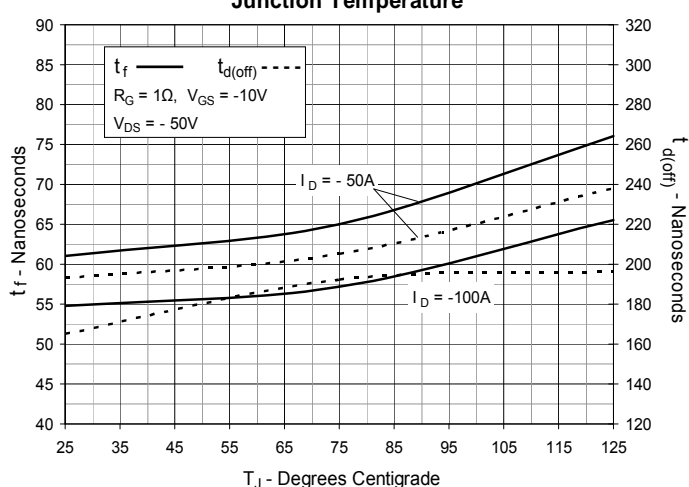

**Fig. 17. Resistive Turn-off Switching Times vs. Drain Current**

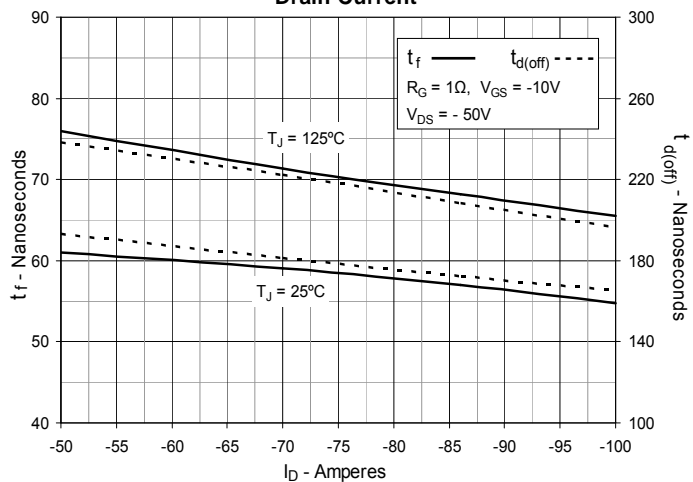

**Fig. 18. Resistive Turn-off Switching Times vs. Gate Resistance**

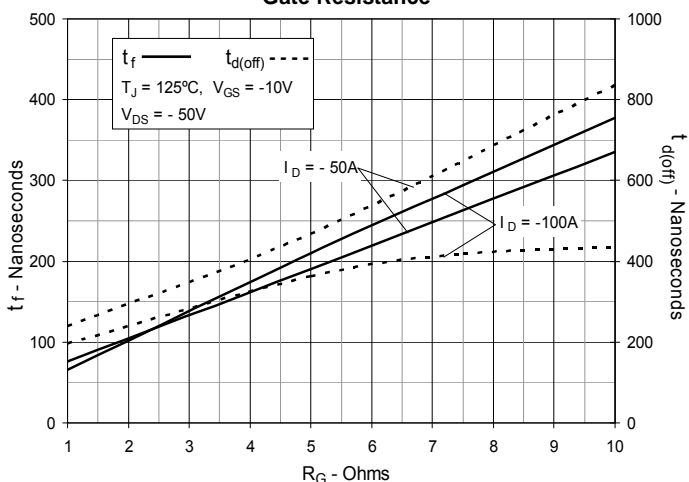

**Fig. 19. Maximum Transient Thermal Impedance**

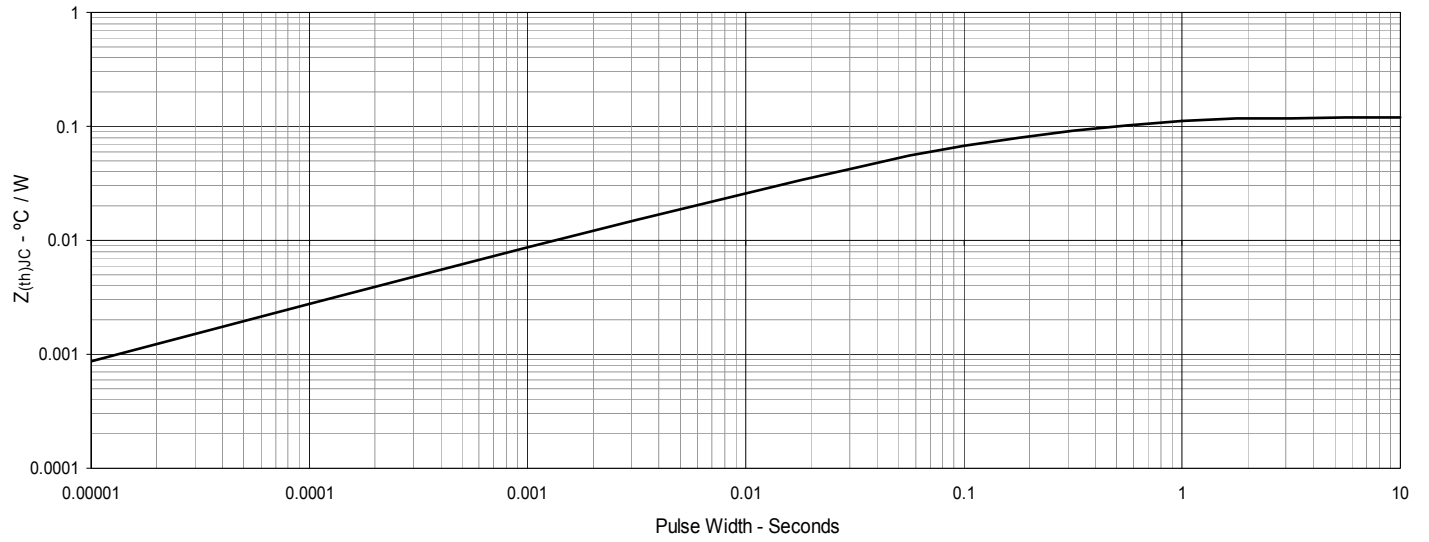



---

Disclaimer Notice - Information furnished is believed to be accurate and reliable. However, users should independently evaluate the suitability of and test each product selected for their own applications. Littelfuse products are not designed for, and may not be used in, all applications. Read complete Disclaimer Notice at [www.littelfuse.com/disclaimer-electronics](http://www.littelfuse.com/disclaimer-electronics).