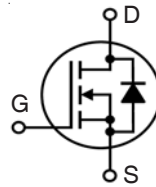


# X4-Class Power MOSFET™

## IXTP170N13X4

N-Channel Enhancement Mode  
Avalanche Rated

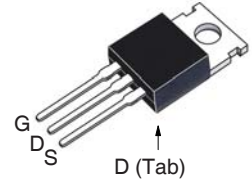


$$V_{DSS} = 135V$$

$$I_{D25} = 170A$$

$$R_{DS(on)} \leq 6.30m\Omega$$

TO-220  
(IXTP)



G = Gate      D = Drain  
S = Source    Tab = Drain

Symbol	Test Conditions	Maximum Ratings	
$V_{DSS}$	$T_J = 25^\circ C$ to $175^\circ C$	135	V
$V_{DGR}$	$T_J = 25^\circ C$ to $175^\circ C$ , $R_{GS} = 1M\Omega$	135	V
$V_{GSS}$	Continuous	$\pm 20$	V
$V_{GSM}$	Transient	$\pm 30$	V
$I_{D25}$	$T_C = 25^\circ C$ (Chip Capability)	170	A
$I_{L(RMS)}$	External Lead Current Limit	120	A
$I_{DM}$	$T_C = 25^\circ C$ , Pulse Width Limited by $T_{JM}$	340	A
$I_A$	$T_C = 25^\circ C$	85	A
$E_{AS}$	$T_C = 25^\circ C$	1	J
dv/dt	$I_S \leq I_{DM}$ , $V_{DD} \leq V_{DSS}$ , $T_J \leq 150^\circ C$	50	V/ns
$P_D$	$T_C = 25^\circ C$	480	W
$T_J$		-55 ... +175	$^\circ C$
$T_{JM}$		175	$^\circ C$
$T_{stg}$		-55 ... +175	$^\circ C$
$T_L$	Maximum Lead Temperature for Soldering	300	$^\circ C$
$T_{SOLD}$	1.6 mm (0.062in.) from Case for 10s	260	$^\circ C$
$M_d$	Mounting Torque	1.13 / 10	Nm/lb.in
Weight		3	g

### Features

- International Standard Package
- Low  $R_{DS(ON)}$  and  $Q_G$
- Avalanche Rated
- Low Package Inductance

### Advantages

- High Power Density
- Easy to Mount
- Space Savings

### Applications

- Switch-Mode and Resonant-Mode Power Supplies
- DC-DC Converters
- PFC Circuits
- AC and DC Motor Drives
- Robotics and Servo Controls

Symbol	Test Conditions ( $T_J = 25^\circ C$ , Unless Otherwise Specified)	Characteristic Values		
		Min.	Typ.	Max.
$BV_{DSS}$	$V_{GS} = 0V$ , $I_D = 250\mu A$	135		V
$V_{GS(th)}$	$V_{DS} = V_{GS}$ , $I_D = 250\mu A$	2.5		4.5 V
$I_{GSS}$	$V_{GS} = \pm 20V$ , $V_{DS} = 0V$			$\pm 100$ nA
$I_{DSS}$	$V_{DS} = V_{DSS}$ , $V_{GS} = 0V$ $T_J = 150^\circ C$			10 $\mu A$ 500 $\mu A$
$R_{DS(on)}$	$V_{GS} = 10V$ , $I_D = 0.5 \cdot I_{D25}$ , Note 1	5.15	6.30	m $\Omega$

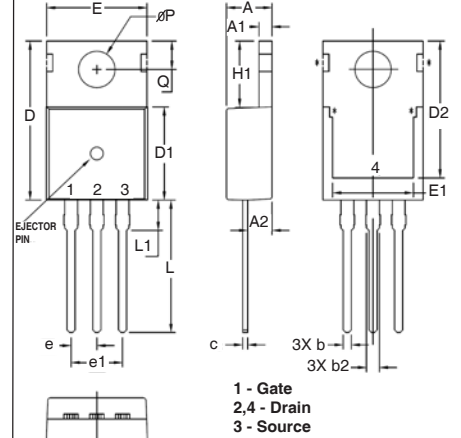
Symbol	Test Conditions ( $T_J = 25^\circ\text{C}$ , Unless Otherwise Specified)	Characteristic Values		
		Min.	Typ.	Max
$g_{fs}$	$V_{DS} = 20\text{V}$ , $I_D = 60\text{A}$ , Note 1	70	120	S
$R_{Gi}$	Gate Input Resistance		0.9	$\Omega$
$C_{iss}$	$V_{GS} = 0\text{V}$ , $V_{DS} = 25\text{V}$ , $f = 1\text{MHz}$		5460	pF
$C_{oss}$			960	pF
$C_{rss}$			29	pF
<b>Effective Output Capacitance</b>				
$C_{o(er)}$	Energy related	$V_{GS} = 0\text{V}$ $V_{DS} = 0.8 \cdot V_{DSS}$	720	pF
$C_{o(tr)}$	Time related		1800	pF
$t_{d(on)}$	<b>Resistive Switching Times</b> $V_{GS} = 10\text{V}$ , $V_{DS} = 0.5 \cdot V_{DSS}$ , $I_D = 0.5 \cdot I_{D25}$ $R_G = 2\Omega$ (External)		26	ns
$t_r$			8	ns
$t_{d(off)}$			46	ns
$t_f$			7	ns
$Q_{g(on)}$	$V_{GS} = 10\text{V}$ , $V_{DS} = 0.5 \cdot V_{DSS}$ , $I_D = 0.5 \cdot I_{D25}$		105	nC
$Q_{gs}$			30	nC
$Q_{gd}$			29	nC
$R_{thJC}$			0.31	$^\circ\text{C/W}$
$R_{thCS}$		0.50		$^\circ\text{C/W}$

### Source-Drain Diode

Symbol	Test Conditions ( $T_J = 25^\circ\text{C}$ , Unless Otherwise Specified)	Characteristic Values		
		Min.	Typ.	Max
$I_s$	$V_{GS} = 0\text{V}$			170 A
$I_{SM}$	Repetitive, pulse Width Limited by $T_{JM}$			680 A
$V_{SD}$	$I_F = 100\text{A}$ , $V_{GS} = 0\text{V}$ , Note 1			1.4 V
$t_{rr}$	$I_F = 85\text{A}$ , $-di/dt = 100\text{A}/\mu\text{s}$ $V_R = 67.5\text{V}$		86	ns
$Q_{RM}$			250	nC
$I_{RM}$			6	A

Note 1. Pulse test,  $t \leq 300\mu\text{s}$ , duty cycle,  $d \leq 2\%$ .

### TO-220 Outline

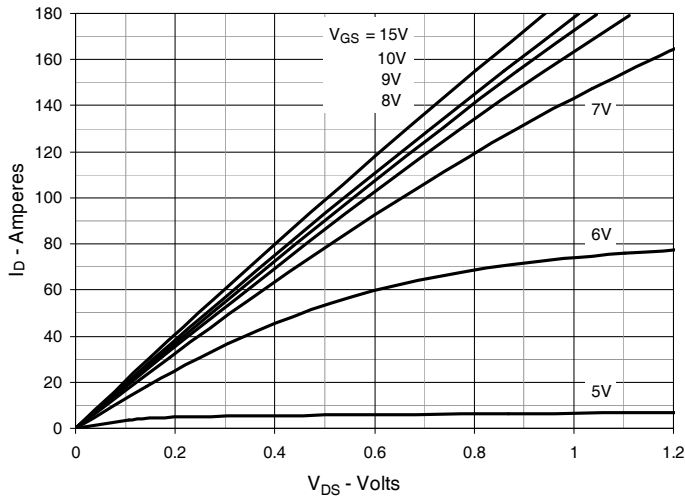


SYM	INCHES		MILLIMETERS	
	MIN	MAX	MIN	MAX
A	.169	.185	4.30	4.70
A1	.047	.055	1.20	1.40
A2	.079	.106	2.00	2.70
b	.024	.039	0.60	1.00
b2	.045	.057	1.15	1.45
c	.014	.026	0.35	0.65
D	.587	.626	14.90	15.90
D1	.335	.370	8.50	9.40
(D2)	.500	.531	12.70	13.50
E	.382	.406	9.70	10.30
(E1)	.283	.323	7.20	8.20
e	.100 BSC		2.54 BSC	
e1	.200 BSC		5.08 BSC	
H1	.244	.268	6.20	6.80
L	.492	.547	12.50	13.90
L1	.110	.154	2.80	3.90
ØP	.134	.150	3.40	3.80
Q	.106	.126	2.70	3.20

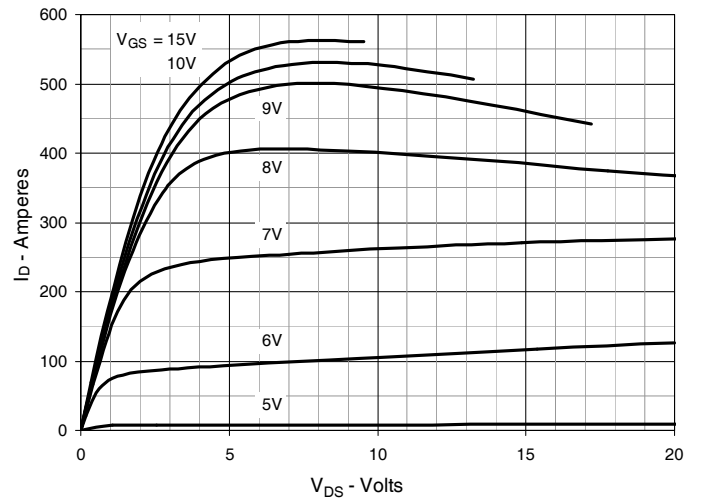
IXYS Reserves the Right to Change Limits, Test Conditions, and Dimensions.

IXYS MOSFETs and IGBTs are covered by one or more of the following U.S. patents:	4,835,592	4,931,844	5,049,961	5,237,481	6,162,665	6,404,065B1	6,683,344	6,727,585	7,005,734B2	7,157,338B2
	4,860,072	5,017,508	5,063,307	5,381,025	6,259,123B1	6,534,343	6,710,405B2	6,759,692	7,063,975B2	
	4,881,106	5,034,796	5,187,117	5,486,715	6,306,728B1	6,583,505	6,710,463	6,771,478B2	7,071,537	

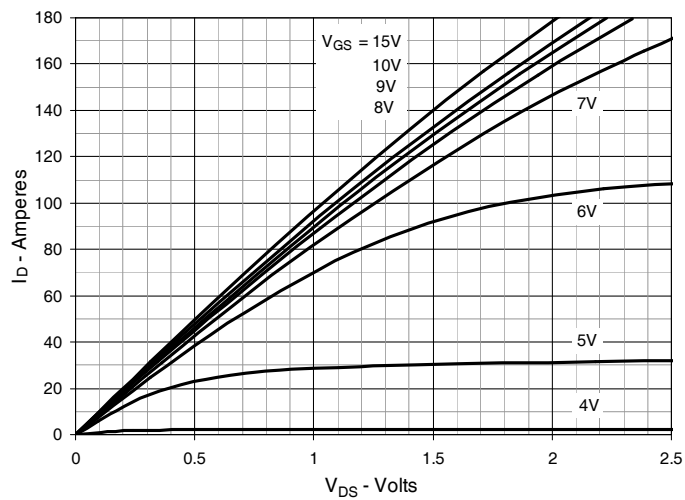
**Fig. 1. Output Characteristics @  $T_J = 25^\circ\text{C}$**



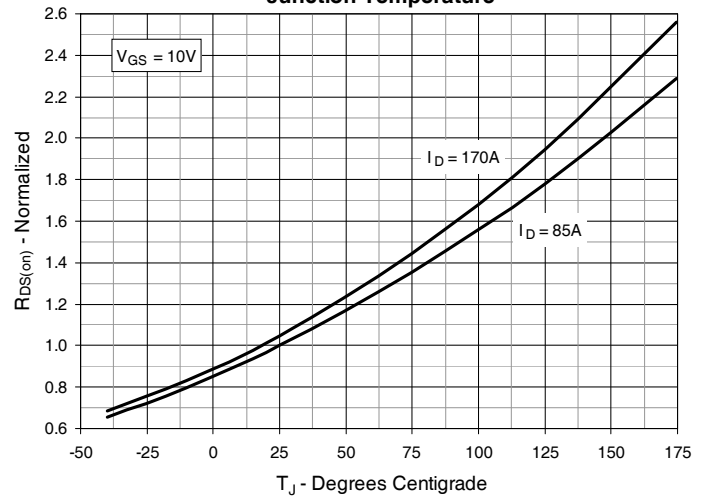
**Fig. 2. Extended Output Characteristics @  $T_J = 25^\circ\text{C}$**



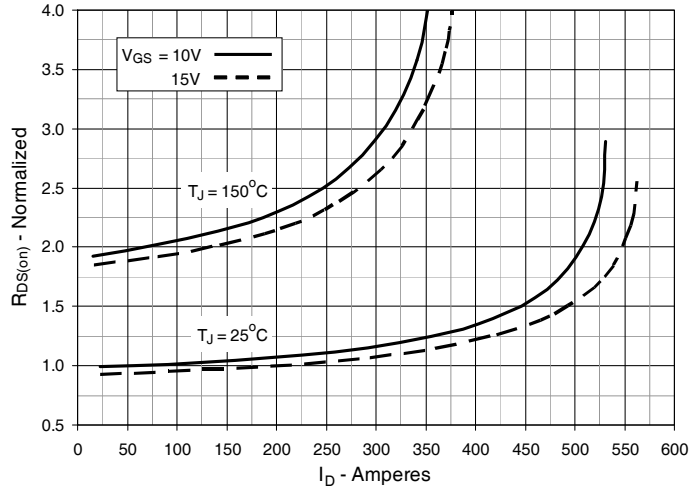
**Fig. 3. Output Characteristics @  $T_J = 150^\circ\text{C}$**



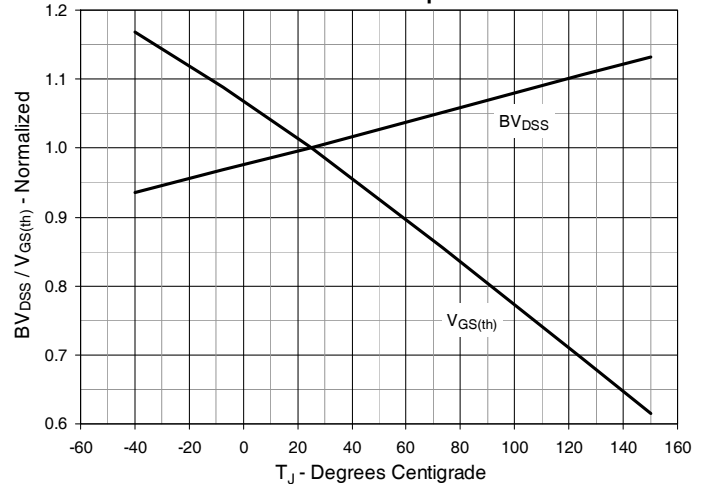
**Fig. 4.  $R_{DS(on)}$  Normalized to  $I_D = 85\text{A}$  Value vs. Junction Temperature**

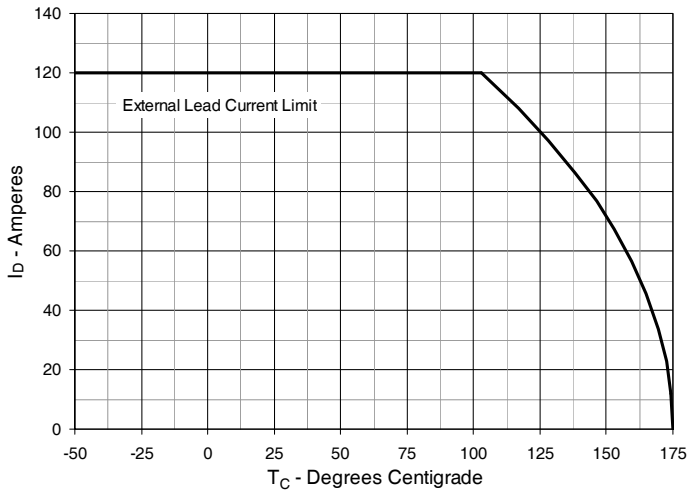
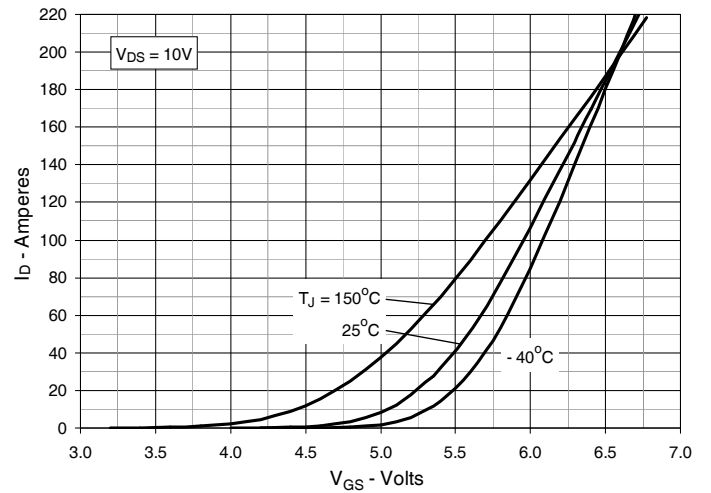
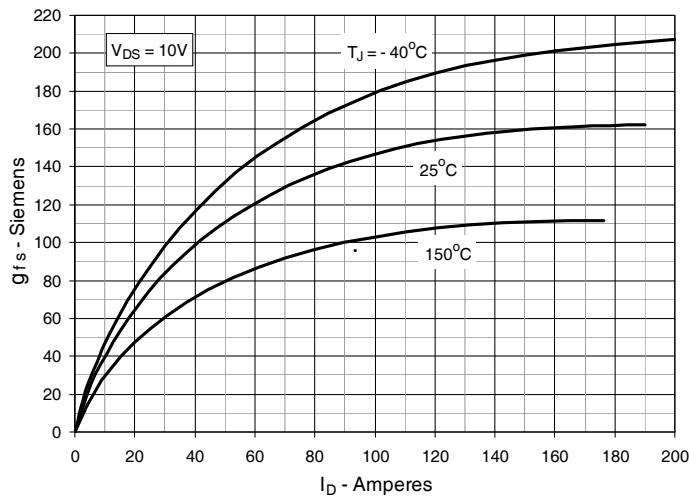
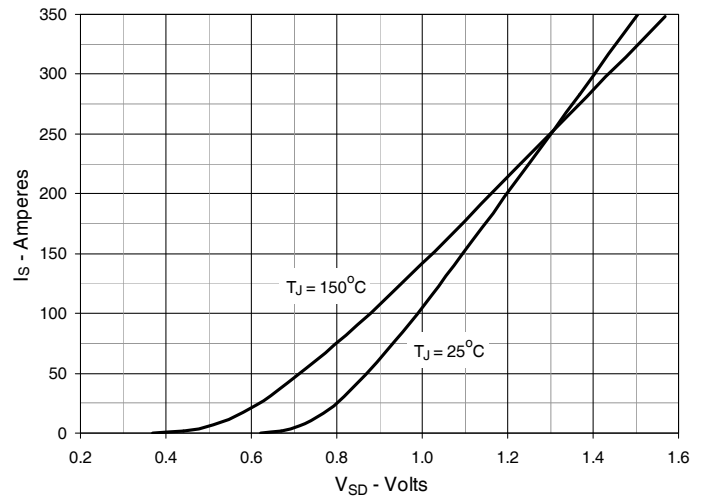
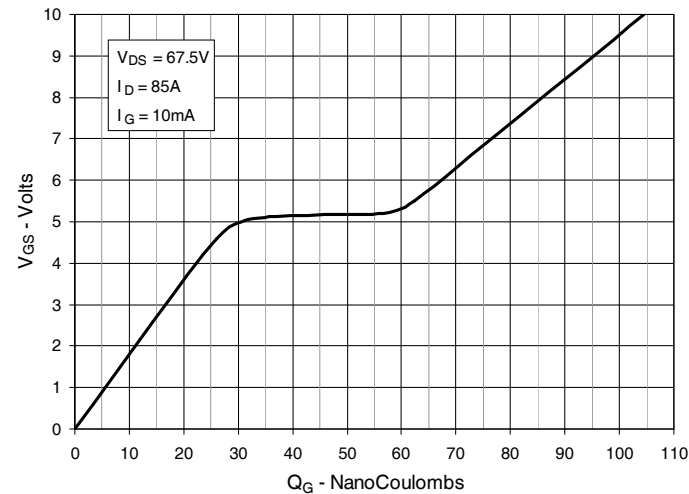
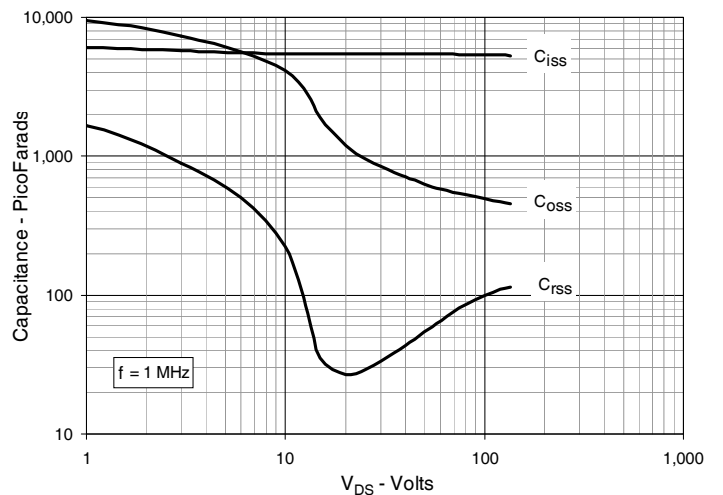


**Fig. 5.  $R_{DS(on)}$  Normalized to  $I_D = 85\text{A}$  Value vs. Drain Current**

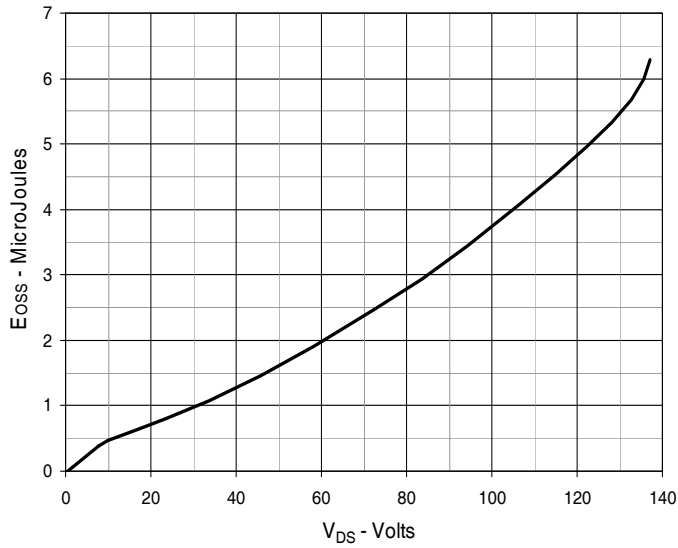


**Fig. 6. Normalized Breakdown & Threshold Voltages vs. Junction Temperature**

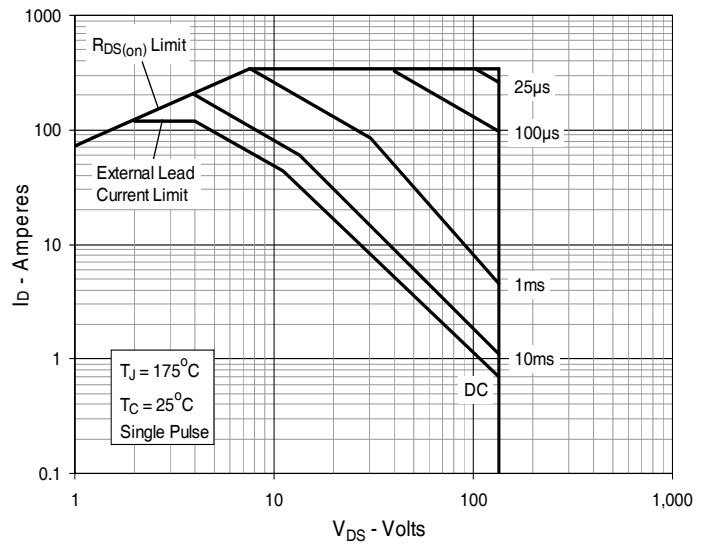


**Fig. 7. Maximum Drain Current vs. Case Temperature**

**Fig. 8. Input Admittance**

**Fig. 9. Transconductance**

**Fig. 10. Forward Voltage Drop of Intrinsic Diode**

**Fig. 11. Gate Charge**

**Fig. 12. Capacitance**


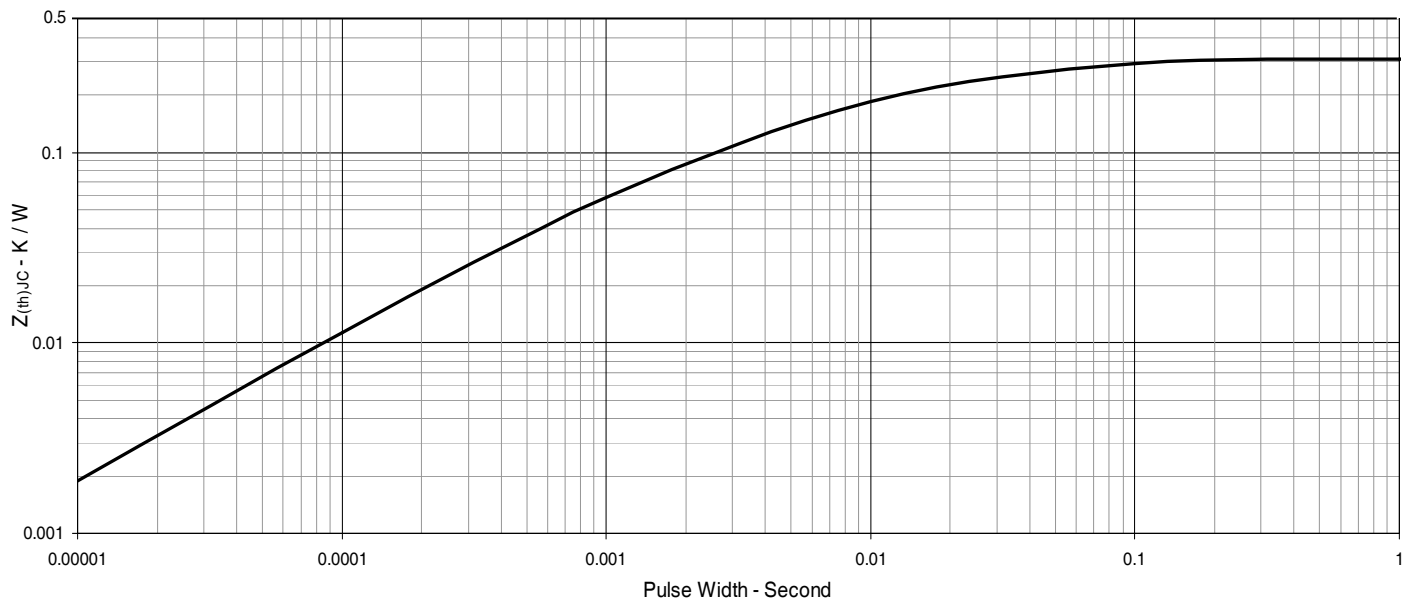
**Fig. 13. Output Capacitance Stored Energy**



**Fig. 14. Forward-Bias Safe Operating Area**



**Fig. 15. Maximum Transient Thermal Impedance**





---

Disclaimer Notice - Information furnished is believed to be accurate and reliable. However, users should independently evaluate the suitability of and test each product selected for their own applications. Littelfuse products are not designed for, and may not be used in, all applications. Read complete Disclaimer Notice at [www.littelfuse.com/disclaimer-electronics](http://www.littelfuse.com/disclaimer-electronics).

IXYS Reserves the Right to Change Limits, Test Conditions, and Dimensions.

---