

# X2-Class HiPERFET Power MOSFET

**IXFY8N65X2**  
**IXFA8N65X2**  
**IXFP8N65X2**

**V<sub>DSS</sub> = 650V**  
**I<sub>D25</sub> = 8A**  
**R<sub>DS(on)</sub> ≤ 450mΩ**

N-Channel Enhancement Mode  
Avalanche Rated

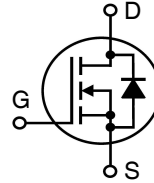

| Symbol            | Test Conditions  | Maximum Ratings   |          |
|-------------------|--|-------------------|----------|
| V <sub>DSS</sub>  | T <sub>J</sub> = 25°C to 150°C   | 650               | V        |
| V <sub>DGR</sub>  | T <sub>J</sub> = 25°C to 150°C, R <sub>GS</sub> = 1MΩ  | 650               | V        |
| V <sub>GSS</sub>  | Continuous   | ±30               | V        |
| V <sub>GSM</sub>  | Transient  | ±40               | V        |
| I <sub>D25</sub>  | T <sub>C</sub> = 25°C  | 8                 | A        |
| I <sub>DM</sub>   | T <sub>C</sub> = 25°C, Pulse Width Limited by T <sub>JM</sub>                                  | 16                | A        |
| I <sub>A</sub>    | T <sub>C</sub> = 25°C  | 4                 | A        |
| E <sub>AS</sub>   | T <sub>C</sub> = 25°C  | 250               | mJ       |
| dv/dt             | I <sub>S</sub> ≤ I <sub>DM</sub> , V <sub>DD</sub> ≤ V <sub>DSS</sub> , T <sub>J</sub> ≤ 150°C | 50                | V/ns     |
| P <sub>D</sub>    | T <sub>C</sub> = 25°C  | 150               | W        |
| T <sub>J</sub>    |  | -55 ... +150      | °C       |
| T <sub>JM</sub>   |  | 150               | °C       |
| T <sub>stg</sub>  |  | -55 ... +150      | °C       |
| T <sub>L</sub>    | Maximum Lead Temperature for Soldering   | 300               | °C       |
| T <sub>SOLD</sub> | 1.6 mm (0.062in.) from Case for 10s  | 260               | °C       |
| F <sub>C</sub>    | Mounting Force (TO-263)  | 10.65 / 2.2..14.6 | N/lb     |
| M <sub>d</sub>    | Mounting Torque (TO-220)   | 1.13 / 10         | Nm/lb.in |
| Weight            | TO-252   | 0.35              | g        |
|                   | TO-263   | 2.50              | g        |
|                   | TO-220   | 3.00              | g        |

TO-252  
(IXFY)

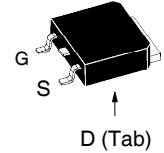

TO-263  
(IXFA)

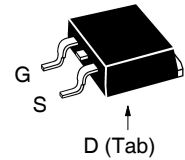

TO-220  
(IXFP)

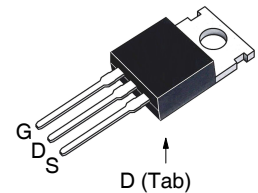

G = Gate      D = Drain  
S = Source    Tab = Drain

## Features

- International Standard Packages
- Low R<sub>DS(ON)</sub> and Q<sub>G</sub>
- Avalanche Rated
- Low Package Inductance

## Advantages

- High Power Density
- Easy to Mount
- Space Savings

## Applications

- Switch-Mode and Resonant-Mode Power Supplies
- DC-DC Converters
- PFC Circuits
- AC and DC Motor Drives
- Robotics and Servo Controls

| Symbol              | Test Conditions<br>(T <sub>J</sub> = 25°C, Unless Otherwise Specified)              | Characteristic Values |      |                 |
|---------------------|---|-----------------------|------|-----------------|
|                     |   | Min.                  | Typ. | Max.            |
| BV <sub>DSS</sub>   | V <sub>GS</sub> = 0V, I <sub>D</sub> = 250μA  | 650                   |      | V               |
| V <sub>GS(th)</sub> | V <sub>DS</sub> = V <sub>GS</sub> , I <sub>D</sub> = 250μA                          | 3.0                   |      | 5.0 V           |
| I <sub>GSS</sub>    | V <sub>GS</sub> = ±30V, V <sub>DS</sub> = 0V  |                       |      | ±100 nA         |
| I <sub>DSS</sub>    | V <sub>DS</sub> = V <sub>DSS</sub> , V <sub>GS</sub> = 0V<br>T <sub>J</sub> = 125°C |                       |      | 10 μA<br>500 μA |
| R <sub>DS(on)</sub> | V <sub>GS</sub> = 10V, I <sub>D</sub> = 0.5 • I <sub>D25</sub> , Note 1             |                       |      | 450 mΩ          |

| Symbol                              | Test Conditions<br>( $T_J = 25^\circ\text{C}$ , Unless Otherwise Specified)                                       | Characteristic Values                                  |      |                         |
|-------------------------------------|---|--|------|-------------------------|
|                                     |   | Min.   | Typ. | Max                     |
| $g_{fs}$                            | $V_{DS} = 10\text{V}$ , $I_D = 0.5 \cdot I_{D25}$ , Note 1  | 3.6  | 6.0  | S                       |
| $R_{Gi}$                            | Gate Input Resistance   |  | 5    | $\Omega$                |
| $C_{iss}$                           | } $V_{GS} = 0\text{V}$ , $V_{DS} = 25\text{V}$ , $f = 1\text{MHz}$  |  | 790  | pF                      |
| $C_{oss}$                           |   |  | 590  | pF                      |
| $C_{rss}$                           |   |  | 2.2  | pF                      |
| <b>Effective Output Capacitance</b> |   |  |      |                         |
| $C_{o(er)}$                         | Energy related  | } $V_{GS} = 0\text{V}$<br>$V_{DS} = 0.8 \cdot V_{DSS}$ | 42   | pF                      |
| $C_{o(tr)}$                         | Time related  |  | 130  | pF                      |
| <b>Resistive Switching Times</b>    |   |  |      |                         |
| $t_{d(on)}$                         | } $V_{GS} = 10\text{V}$ , $V_{DS} = 0.5 \cdot V_{DSS}$ , $I_D = 0.5 \cdot I_{D25}$<br>$R_G = 30\Omega$ (External) |  | 17   | ns                      |
| $t_r$                               |   |  | 11   | ns                      |
| $t_{d(off)}$                        |   |  | 29   | ns                      |
| $t_f$                               |   |  | 15   | ns                      |
| $Q_{g(on)}$                         | } $V_{GS} = 10\text{V}$ , $V_{DS} = 0.5 \cdot V_{DSS}$ , $I_D = 0.5 \cdot I_{D25}$                                |  | 11.0 | nC                      |
| $Q_{gs}$                            |   |  | 2.3  | nC                      |
| $Q_{gd}$                            |   |  | 6.2  | nC                      |
| $R_{thJC}$                          | TO-220  |  |      | 0.83 $^\circ\text{C/W}$ |
| $R_{thCS}$                          |   |  | 0.50 | $^\circ\text{C/W}$      |

**Source-Drain Diode**

| Symbol   | Test Conditions<br>( $T_J = 25^\circ\text{C}$ , Unless Otherwise Specified)     | Characteristic Values |      |       |
|----------|---|-----------------------|------|-------|
|          |   | Min.                  | Typ. | Max   |
| $I_S$    | $V_{GS} = 0\text{V}$  |                       |      | 8 A   |
| $I_{SM}$ | Repetitive, Pulse Width Limited by $T_{JM}$                                     |                       |      | 32 A  |
| $V_{SD}$ | $I_F = I_S$ , $V_{GS} = 0\text{V}$ , Note 1                                     |                       |      | 1.4 V |
| $t_{rr}$ | } $I_F = 4\text{A}$ , $-di/dt = 100\text{A}/\mu\text{s}$<br>$V_R = 100\text{V}$ |                       | 105  | ns    |
| $Q_{RM}$ |   |                       | 460  | nC    |
| $I_{RM}$ |   |                       | 8.7  | A     |

Note 1. Pulse test,  $t \leq 300\mu\text{s}$ , duty cycle,  $d \leq 2\%$ .

IXYS Reserves the Right to Change Limits, Test Conditions, and Dimensions.

|  |           |           |           |           |             |             |             |             |             |             |
|--|-----------|-----------|-----------|-----------|-------------|-------------|-------------|-------------|-------------|-------------|
| IXYS MOSFETs and IGBTs are covered by one or more of the following U.S. patents: | 4,835,592 | 4,931,844 | 5,049,961 | 5,237,481 | 6,162,665   | 6,404,065B1 | 6,683,344   | 6,727,585   | 7,005,734B2 | 7,157,338B2 |
|  | 4,860,072 | 5,017,508 | 5,063,307 | 5,381,025 | 6,259,123B1 | 6,534,343   | 6,710,405B2 | 6,759,692   | 7,063,975B2 |             |
|  | 4,881,106 | 5,034,796 | 5,187,117 | 5,486,715 | 6,306,728B1 | 6,583,505   | 6,710,463   | 6,771,478B2 | 7,071,537   |             |

Fig. 1. Output Characteristics @  $T_J = 25^\circ\text{C}$

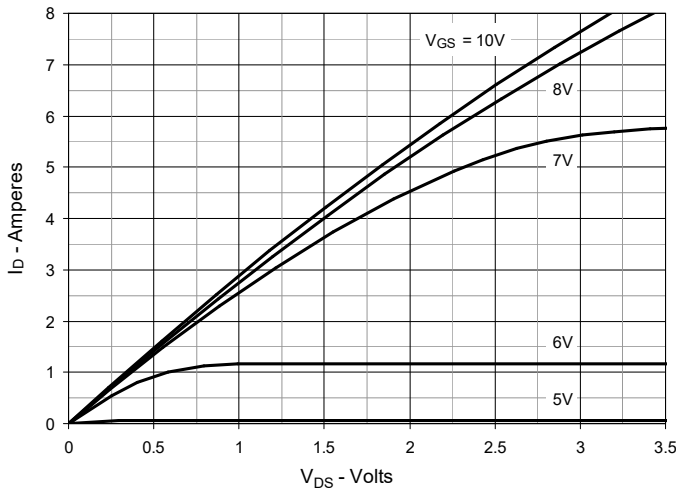

Fig. 2. Extended Output Characteristics @  $T_J = 25^\circ\text{C}$

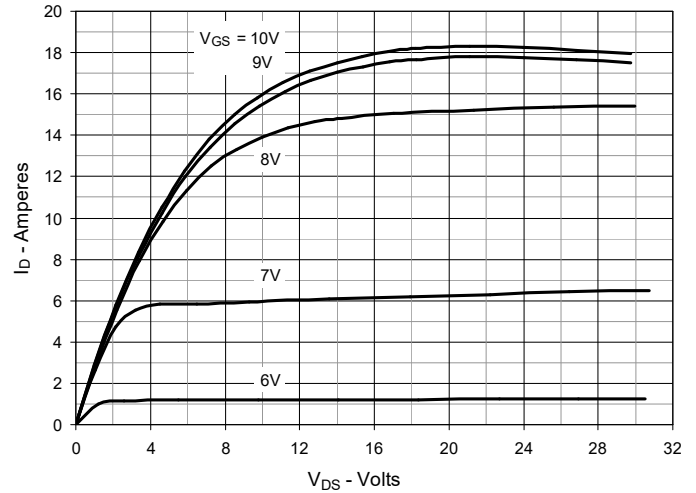

Fig. 3. Output Characteristics @  $T_J = 125^\circ\text{C}$

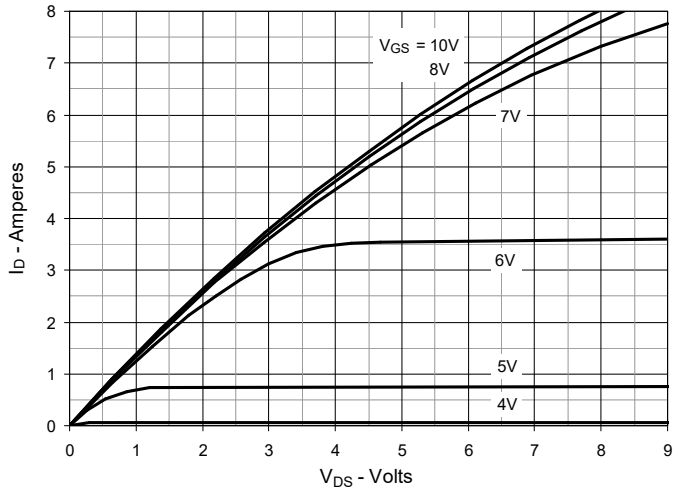

Fig. 4.  $R_{DS(on)}$  Normalized to  $I_D = 4\text{A}$  Value vs. Junction Temperature

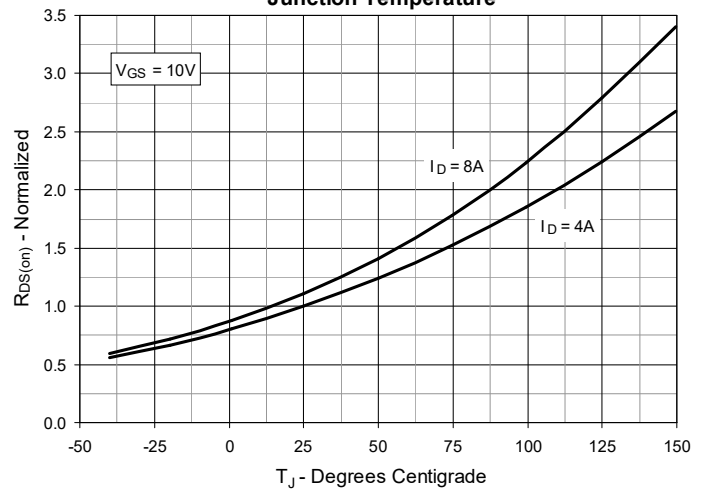

Fig. 5.  $R_{DS(on)}$  Normalized to  $I_D = 4\text{A}$  Value vs. Drain Current

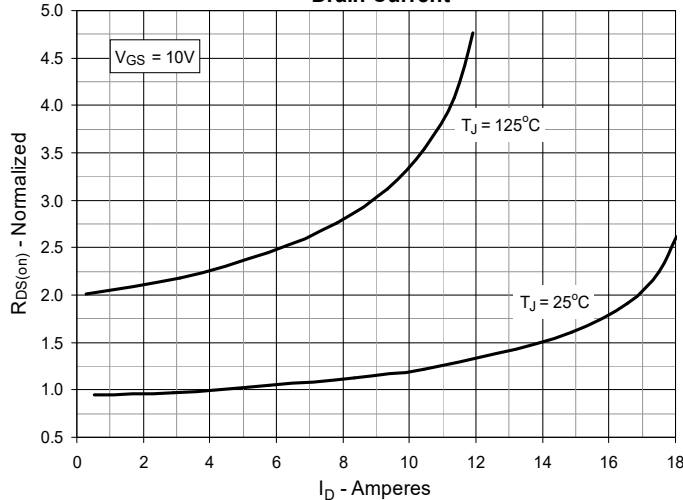

Fig. 6. Maximum Drain Current vs. Case Temperature

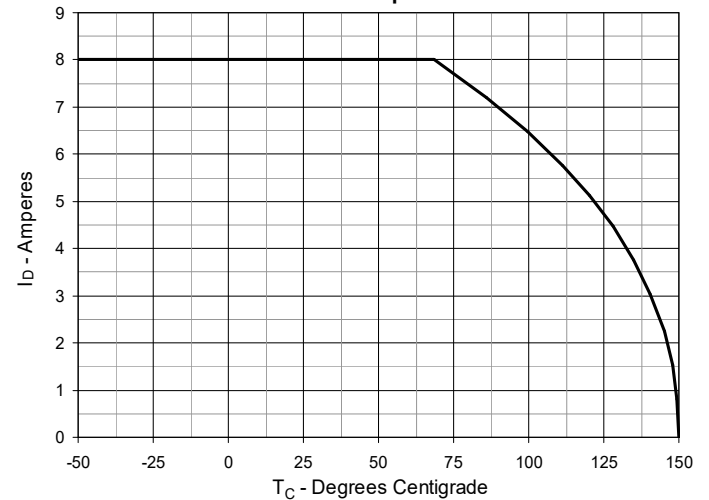

Fig. 7. Input Admittance

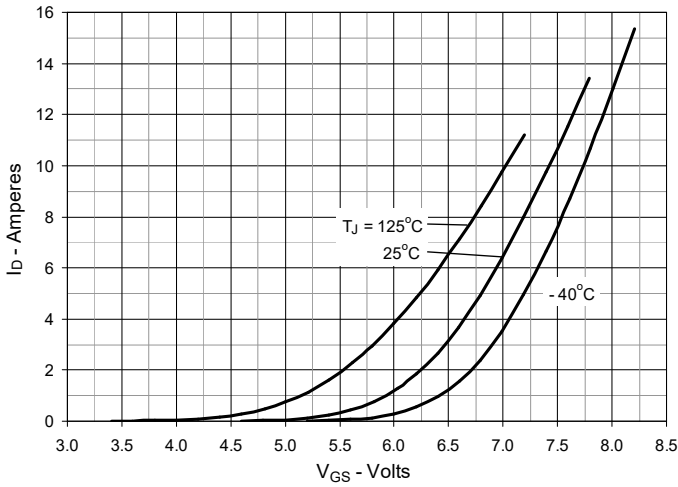

Fig. 8. Transconductance

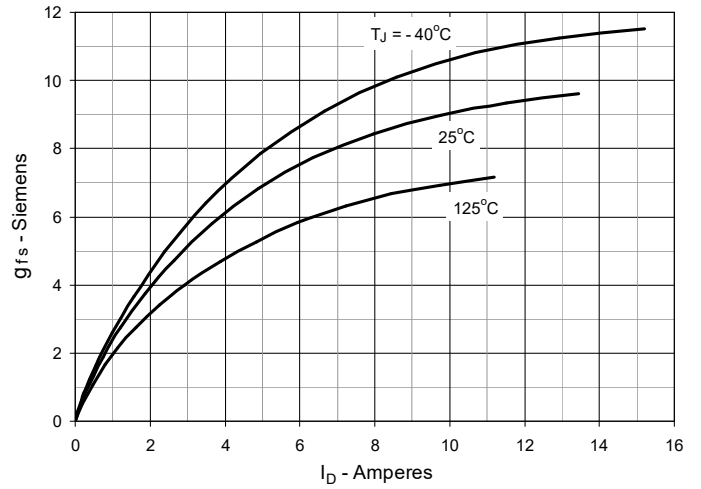

Fig. 9. Forward Voltage Drop of Intrinsic Diode

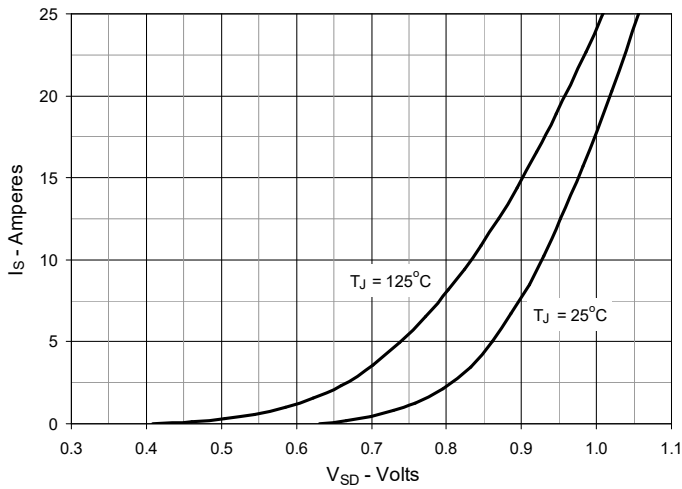

Fig. 10. Gate Charge

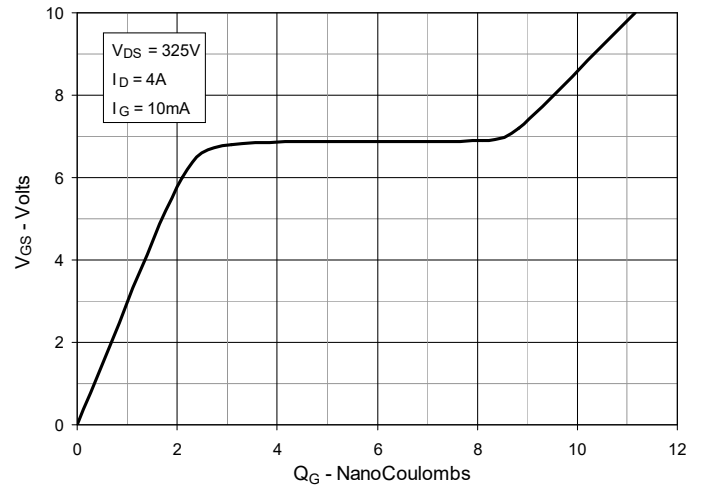

Fig. 11. Capacitance

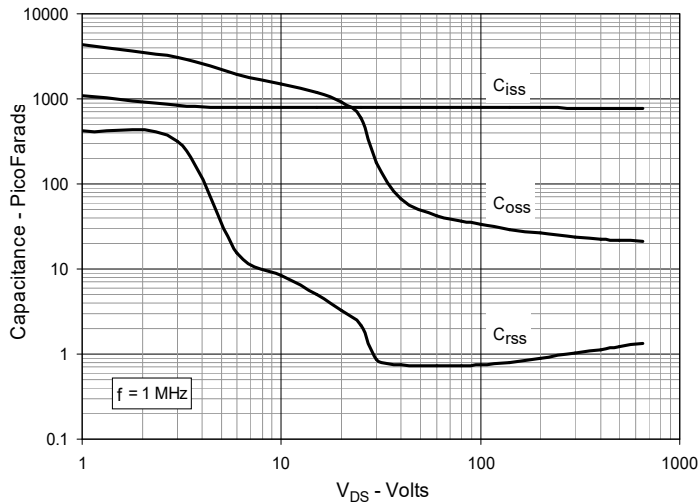
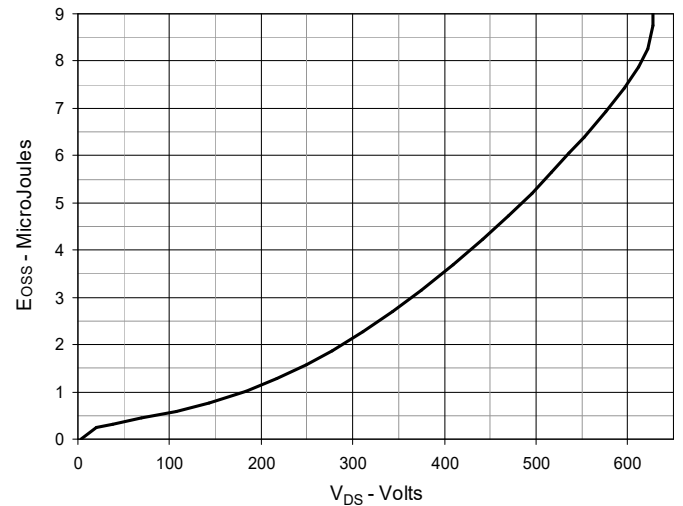
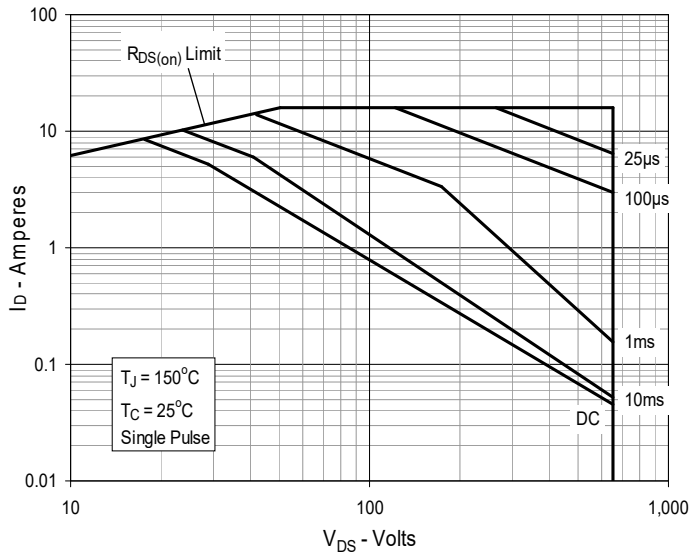

Fig. 12. Output Capacitance Stored Energy



**Fig. 13. Forward-Bias Safe Operating Area**



**Fig. 14. Maximum Transient Thermal Impedance**

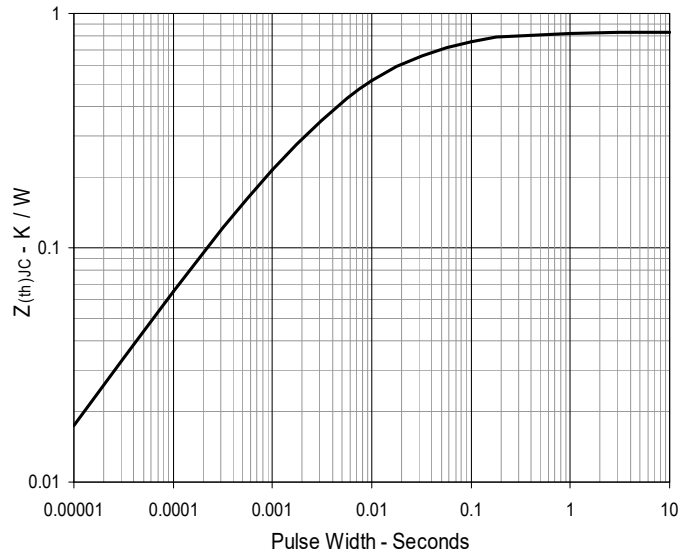

### TO-252 Outline

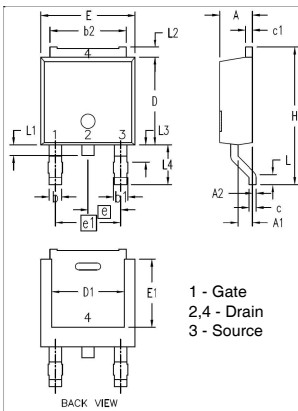

| SYM | INCHES   |      | MILLIMETERS |       |
|-----|----------|------|-------------|-------|
|     | MIN      | MAX  | MIN         | MAX   |
| A   | .086     | .094 | 2.19        | 2.38  |
| A1  | .035     | .045 | 0.89        | 1.14  |
| A2  | 0        | .004 | 0           | 0.10  |
| b   | .025     | .035 | 0.64        | 0.89  |
| b1  | .030     | .045 | 0.76        | 1.14  |
| b2  | .205     | .215 | 5.21        | 5.46  |
| c   | .018     | .023 | 0.46        | 0.58  |
| c1  | .018     | .023 | 0.46        | 0.58  |
| D   | .235     | .245 | 5.97        | 6.22  |
| D1  | .170     | .205 | 4.32        | 5.21  |
| E   | .250     | .265 | 6.35        | 6.73  |
| E1  | .170     | .205 | 4.32        | 5.21  |
| e   | .090 BSC |      | 2.28 BSC    |       |
| e1  | .180 BSC |      | 4.57 BSC    |       |
| H   | .370     | .410 | 9.40        | 10.42 |
| L   | .020     | .040 | 0.51        | 1.02  |
| L1  | .025     | .040 | 0.64        | 1.02  |
| L2  | .024     | .036 | 0.60        | 0.90  |
| L3  | .045     | .060 | 1.15        | 1.52  |
| L4  | .100     | .115 | 2.54        | 2.92  |

### TO-263 Outline

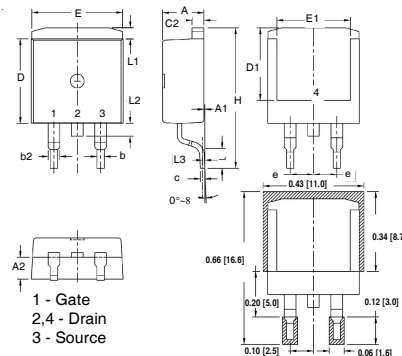

| SYM  | INCHES   |      | MILLIMETER |       |
|------|----------|------|------------|-------|
|      | MIN      | MAX  | MIN        | MAX   |
| A    | .170     | .185 | 4.30       | 4.70  |
| A1   | .000     | .008 | 0.00       | 0.20  |
| A2   | .091     | .098 | 2.30       | 2.50  |
| b    | .028     | .035 | 0.70       | 0.90  |
| b2   | .046     | .060 | 1.18       | 1.52  |
| C    | .018     | .024 | 0.45       | 0.60  |
| C2   | .049     | .060 | 1.25       | 1.52  |
| D    | .340     | .370 | 8.63       | 9.40  |
| D1   | .300     | .327 | 7.62       | 8.30  |
| E    | .380     | .410 | 9.65       | 10.41 |
| E1   | .270     | .330 | 6.86       | 8.38  |
| [e]  | .100 BSC |      | 2.54 BSC   |       |
| H    | .580     | .620 | 14.73      | 15.75 |
| L    | .075     | .105 | 1.91       | 2.67  |
| L1   | .039     | .060 | 1.00       | 1.52  |
| L2   | —        | .070 | —          | 1.77  |
| [L3] | .010 BSC |      | 0.254 BSC  |       |

### TO-220 Outline

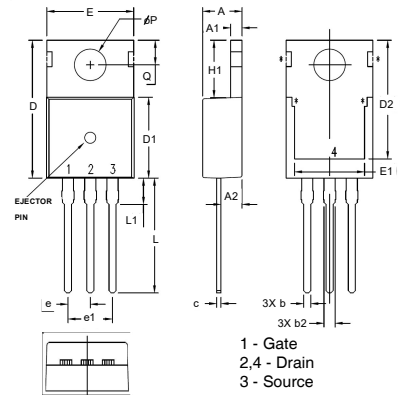

| SYM  | INCHES   |      | MILLIMETERS |       |
|------|----------|------|-------------|-------|
|      | MIN      | MAX  | MIN         | MAX   |
| A    | .169     | .185 | 4.30        | 4.70  |
| A1   | .047     | .055 | 1.20        | 1.40  |
| A2   | .079     | .106 | 2.00        | 2.70  |
| b    | .024     | .039 | 0.60        | 1.00  |
| b2   | .045     | .057 | 1.15        | 1.45  |
| c    | .014     | .026 | 0.35        | 0.65  |
| D    | .587     | .626 | 14.90       | 15.90 |
| D1   | .335     | .370 | 8.50        | 9.40  |
| (D2) | .500     | .531 | 12.70       | 13.50 |
| E    | .382     | .406 | 9.70        | 10.30 |
| (E1) | .283     | .323 | 7.20        | 8.20  |
| e    | .100 BSC |      | 2.54 BSC    |       |
| e1   | .200 BSC |      | 5.08 BSC    |       |
| H1   | .244     | .268 | 6.20        | 6.80  |
| L    | .492     | .547 | 12.50       | 13.90 |
| L1   | .110     | .154 | 2.80        | 3.90  |
| ∅P   | .134     | .150 | 3.40        | 3.80  |
| Q    | .106     | .126 | 2.70        | 3.20  |



---

Disclaimer Notice - Information furnished is believed to be accurate and reliable. However, users should independently evaluate the suitability of and test each product selected for their own applications. Littelfuse products are not designed for, and may not be used in, all applications. Read complete Disclaimer Notice at [www.littelfuse.com/disclaimer-electronics](http://www.littelfuse.com/disclaimer-electronics).

---