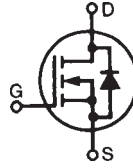
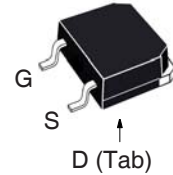
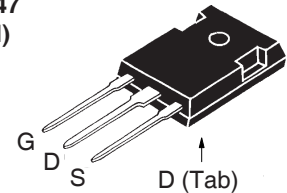
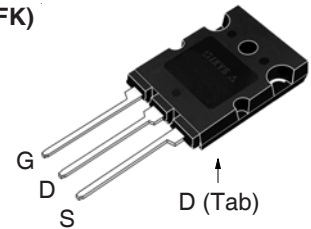

**X-Class HiPerFET™  
Power MOSFET**
**IXFT32N100XHV  
IXFH32N100X  
IXFK32N100X**
 $V_{DSS} = 1000V$   
 $I_{D25} = 32A$   
 $R_{DS(on)} \leq 220m\Omega$ 

 N-Channel Enhancement Mode  
 Avalanche Rated

| Symbol        | Test Conditions  | Maximum Ratings |            |
|---------------|--|-----------------|------------|
| $V_{DSS}$     | $T_J = 25^\circ C$ to $150^\circ C$                                | 1000            | V          |
| $V_{DGR}$     | $T_J = 25^\circ C$ to $150^\circ C$ , $R_{GS} = 1M\Omega$          | 1000            | V          |
| $V_{GSS}$     | Continuous   | $\pm 30$        | V          |
| $V_{GSM}$     | Transient  | $\pm 40$        | V          |
| $I_{D25}$     | $T_C = 25^\circ C$   | 32              | A          |
| $I_{DM}$      | $T_C = 25^\circ C$ , Pulse Width Limited by $T_{JM}$               | 64              | A          |
| $I_A$         | $T_C = 25^\circ C$   | 16              | A          |
| $E_{AS}$      | $T_C = 25^\circ C$   | 2               | J          |
| $dv/dt$       | $I_S \leq I_{DM}$ , $V_{DD} \leq V_{DSS}$ , $T_J \leq 150^\circ C$ | 50              | V/ns       |
| $P_D$         | $T_C = 25^\circ C$   | 890             | W          |
| $T_J$         |  | -55 ... +150    | $^\circ C$ |
| $T_{JM}$      |  | 150             | $^\circ C$ |
| $T_{stg}$     |  | -55 ... +150    | $^\circ C$ |
| $T_L$         | Maximum Lead Temperature for Soldering                             | 300             | $^\circ C$ |
| $T_{SOLD}$    | 1.6 mm (0.062in.) from Case for 10s                                | 260             | $^\circ C$ |
| $M_d$         | Mounting Torque (TO-247 & TO-264P)                                 | 1.13 / 10       | Nm/lb.in   |
| <b>Weight</b> | TO-268HV   | 4               | g          |
|               | TO-247   | 6               | g          |
|               | TO-264P  | 10              | g          |

| Symbol       | Test Conditions<br>( $T_J = 25^\circ C$ , Unless Otherwise Specified) | Characteristic Values |      |                    |
|--------------|---|-----------------------|------|--------------------|
|              |   | Min.                  | Typ. | Max.               |
| $BV_{DSS}$   | $V_{GS} = 0V$ , $I_D = 1mA$   | 1000                  |      | V                  |
| $V_{GS(th)}$ | $V_{DS} = V_{GS}$ , $I_D = 4mA$                                       | 3.5                   |      | 6.0 V              |
| $I_{GSS}$    | $V_{GS} = \pm 30V$ , $V_{DS} = 0V$                                    |                       |      | $\pm 100$ nA       |
| $I_{DSS}$    | $V_{DS} = V_{DSS}$ , $V_{GS} = 0V$<br>$T_J = 125^\circ C$             |                       |      | 50 $\mu A$<br>3 mA |
| $R_{DS(on)}$ | $V_{GS} = 10V$ , $I_D = 0.5 \cdot I_{D25}$ , Note 1                   |                       |      | 220 m $\Omega$     |

 TO-268HV  
(IXFT..HV)

 TO-247  
(IXFH)

 TO-264P  
(IXFK)

 G = Gate      D = Drain  
 S = Source    Tab = Drain

**Features**

- International Standard Packages
- Low  $R_{DS(ON)}$  and  $Q_G$
- Avalanche Rated
- Low Package Inductance

**Advantages**

- High Power Density
- Easy to Mount
- Space Savings

**Applications**

- Switch-Mode and Resonant-Mode Power Supplies
- DC-DC Converters
- PFC Circuits
- AC and DC Motor Drives
- Robotics and Servo Controls

| Symbol                              | Test Conditions<br>( $T_J = 25^\circ\text{C}$ , Unless Otherwise Specified)                                      | Characteristic Values                                  |      |                         |
|-------------------------------------|--|--|------|-------------------------|
|                                     |  | Min.   | Typ. | Max                     |
| $g_{fs}$                            | $V_{DS} = 20\text{V}$ , $I_D = 16\text{A}$ , Note 1  | 14   | 23   | S                       |
| $R_{Gi}$                            | Gate Input Resistance  |  | 0.6  | $\Omega$                |
| $C_{iss}$                           | } $V_{GS} = 0\text{V}$ , $V_{DS} = 25\text{V}$ , $f = 1\text{MHz}$   |  | 4075 | pF                      |
| $C_{oss}$                           |  |  | 520  | pF                      |
| $C_{rss}$                           |  |  | 10   | pF                      |
| <b>Effective Output Capacitance</b> |  |  |      |                         |
| $C_{o(er)}$                         | Energy related   | } $V_{GS} = 0\text{V}$<br>$V_{DS} = 0.8 \cdot V_{DSS}$ | 140  | pF                      |
| $C_{o(tr)}$                         | Time related   |  | 585  | pF                      |
| <b>Resistive Switching Times</b>    |  |  |      |                         |
| $t_{d(on)}$                         | } $V_{GS} = 10\text{V}$ , $V_{DS} = 0.5 \cdot V_{DSS}$ , $I_D = 0.5 \cdot I_{D25}$<br>$R_G = 2\Omega$ (External) |  | 29   | ns                      |
| $t_r$                               |  |  | 12   | ns                      |
| $t_{d(off)}$                        |  |  | 80   | ns                      |
| $t_f$                               |  |  | 12   | ns                      |
| $Q_{g(on)}$                         | } $V_{GS} = 10\text{V}$ , $V_{DS} = 0.5 \cdot V_{DSS}$ , $I_D = 0.5 \cdot I_{D25}$                               |  | 130  | nC                      |
| $Q_{gs}$                            |  |  | 27   | nC                      |
| $Q_{gd}$                            |  |  | 70   | nC                      |
| $R_{thJC}$                          |  |  |      | 0.14 $^\circ\text{C/W}$ |
| $R_{thCS}$                          | TO-247   |  | 0.21 | $^\circ\text{C/W}$      |
|                                     | TO-264P  |  | 0.15 | $^\circ\text{C/W}$      |

**Source-Drain Diode**

| Symbol   | Test Conditions<br>( $T_J = 25^\circ\text{C}$ , Unless Otherwise Specified)      | Characteristic Values |      |               |
|----------|--|-----------------------|------|---------------|
|          |  | Min.                  | Typ. | Max           |
| $I_S$    | $V_{GS} = 0\text{V}$   |                       |      | 32 A          |
| $I_{SM}$ | Repetitive, pulse Width Limited by $T_{JM}$                                      |                       |      | 128 A         |
| $V_{SD}$ | $I_F = I_S$ , $V_{GS} = 0\text{V}$ , Note 1                                      |                       |      | 1.4 V         |
| $t_{rr}$ | } $I_F = 16\text{A}$ , $-di/dt = 100\text{A}/\mu\text{s}$<br>$V_R = 100\text{V}$ |                       | 200  | ns            |
| $Q_{RM}$ |  |                       | 1.5  | $\mu\text{C}$ |
| $I_{RM}$ |  |                       | 15   | A             |

Note 1. Pulse test,  $t \leq 300\mu\text{s}$ , duty cycle,  $d \leq 2\%$ .

**PRELIMINARY TECHNICAL INFORMATION**

The product presented herein is under development. The Technical Specifications offered are derived from a subjective evaluation of the design, based upon prior knowledge and experience, and constitute a "considered reflection" of the anticipated result. IXYS reserves the right to change limits, test conditions, and dimensions without notice.

IXYS Reserves the Right to Change Limits, Test Conditions, and Dimensions.

|  |           |           |           |           |             |             |             |             |             |             |
|--|-----------|-----------|-----------|-----------|-------------|-------------|-------------|-------------|-------------|-------------|
| IXYS MOSFETs and IGBTs are covered by one or more of the following U.S. patents: | 4,835,592 | 4,931,844 | 5,049,961 | 5,237,481 | 6,162,665   | 6,404,065B1 | 6,683,344   | 6,727,585   | 7,005,734B2 | 7,157,338B2 |
|  | 4,860,072 | 5,017,508 | 5,063,307 | 5,381,025 | 6,259,123B1 | 6,534,343   | 6,710,405B2 | 6,759,692   | 7,063,975B2 |             |
|  | 4,881,106 | 5,034,796 | 5,187,117 | 5,486,715 | 6,306,728B1 | 6,583,505   | 6,710,463   | 6,771,478B2 | 7,071,537   |             |

Fig. 1. Output Characteristics @  $T_J = 25^\circ\text{C}$

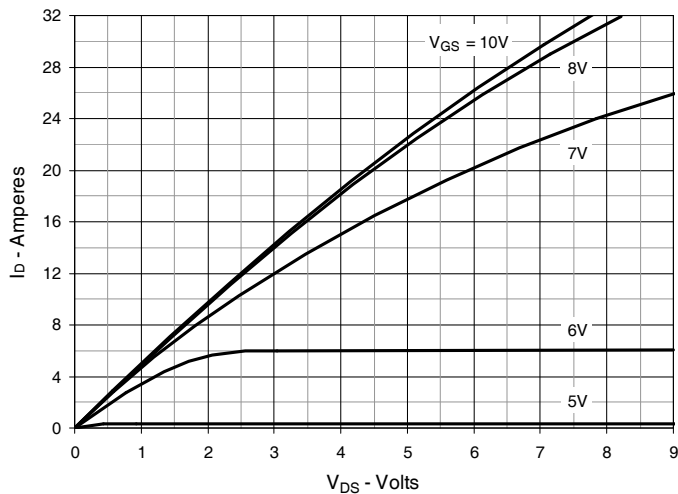

Fig. 2. Extended Output Characteristics @  $T_J = 25^\circ\text{C}$

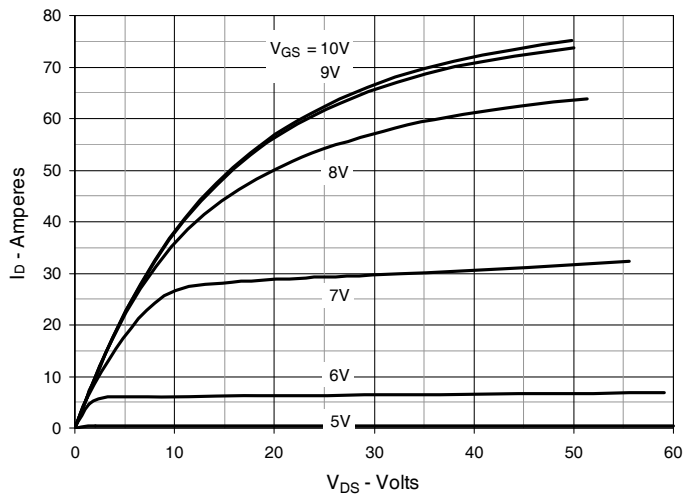

Fig. 3. Output Characteristics @  $T_J = 125^\circ\text{C}$

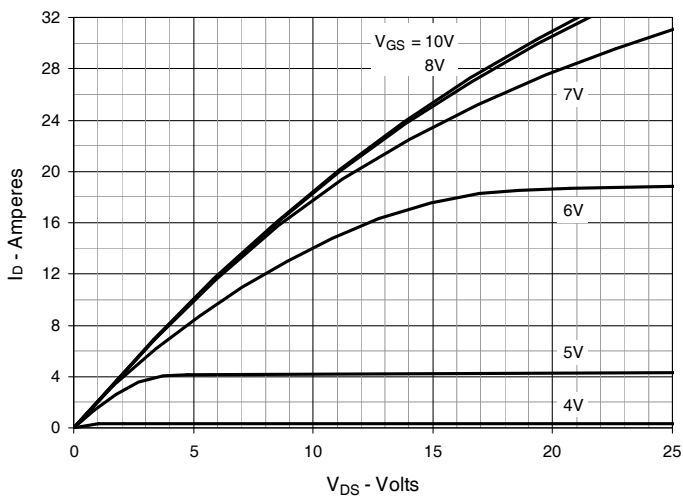

Fig. 4.  $R_{DS(on)}$  Normalized to  $I_D = 16\text{A}$  Value vs. Junction Temperature

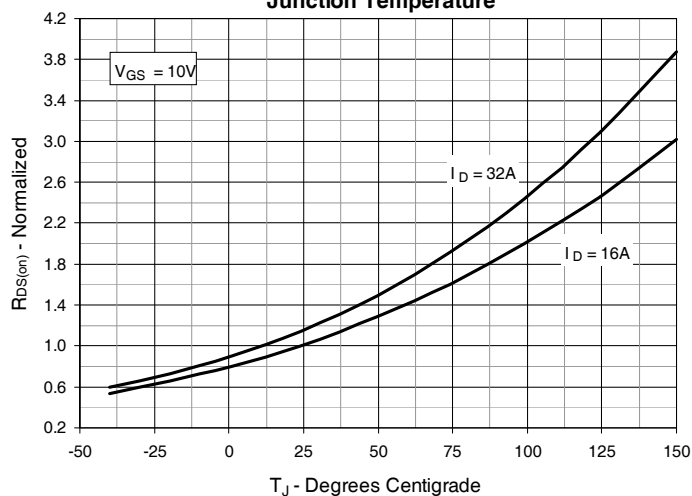

Fig. 5.  $R_{DS(on)}$  Normalized to  $I_D = 16\text{A}$  Value vs. Drain Current

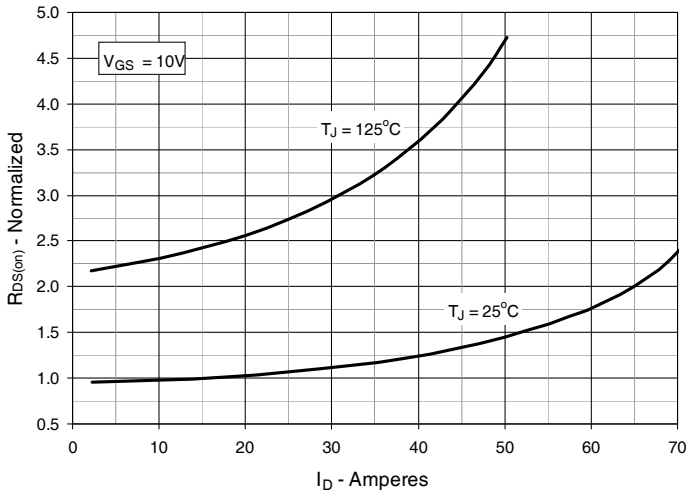

Fig. 6. Normalized Breakdown & Threshold Voltages vs. Junction Temperature

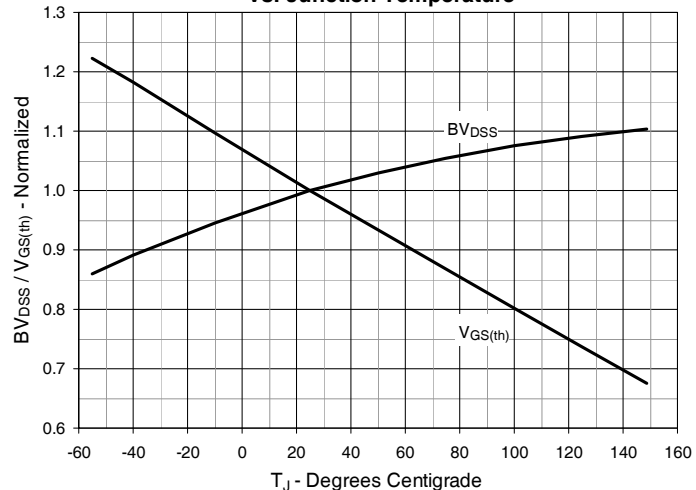

Fig. 7. Maximum Drain Current vs. Case Temperature

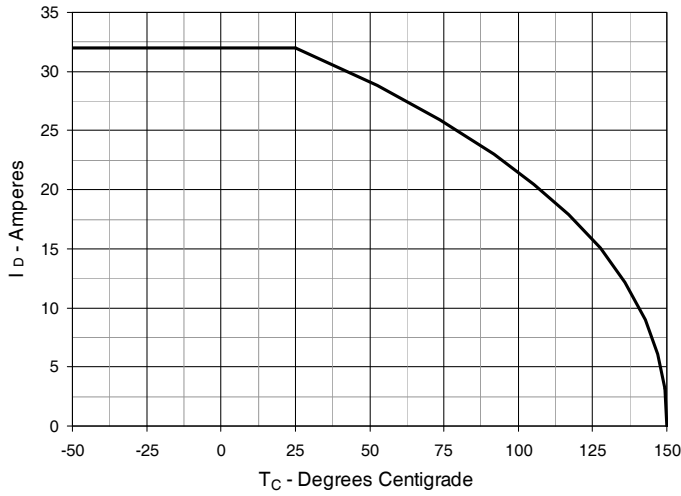

Fig. 8. Input Admittance

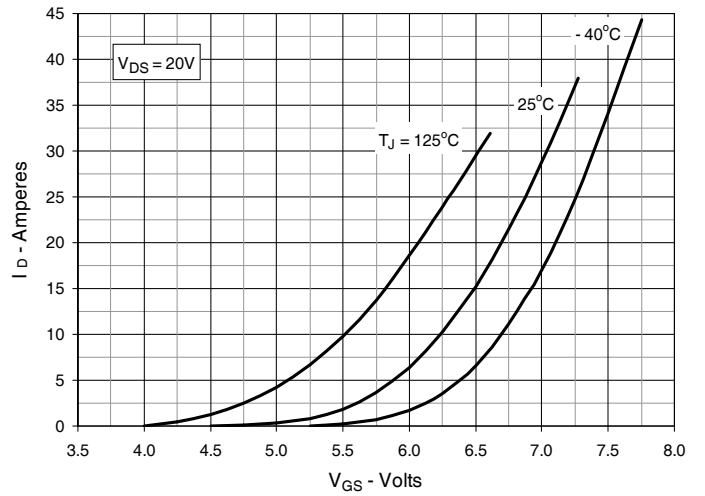

Fig. 9. Transconductance

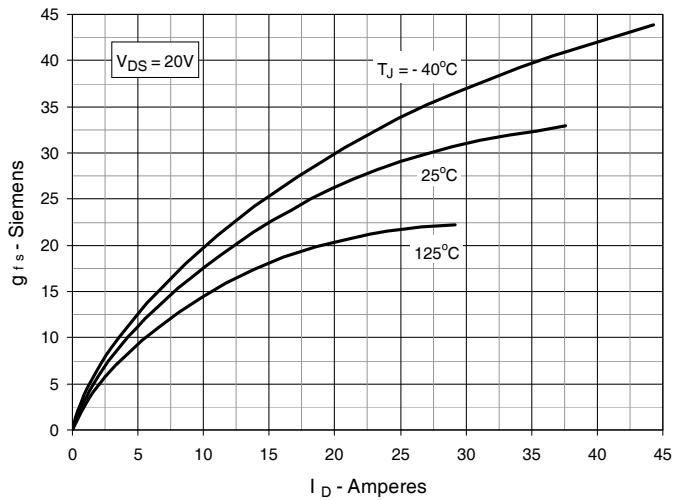

Fig. 10. Forward Voltage Drop of Intrinsic Diode

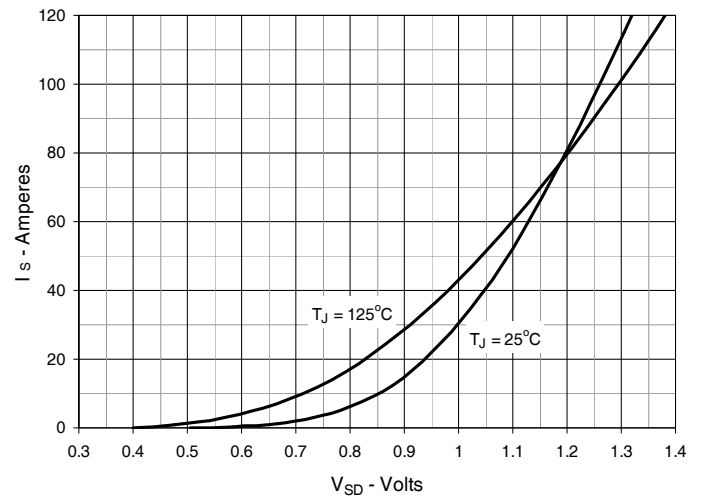

Fig. 11. Gate Charge

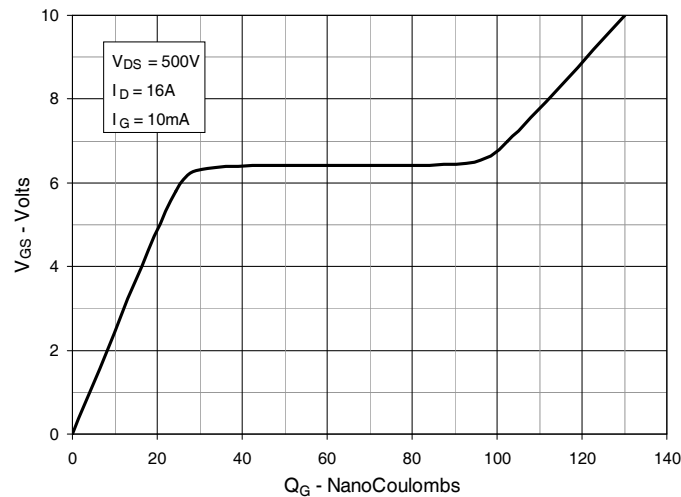

Fig. 12. Capacitance

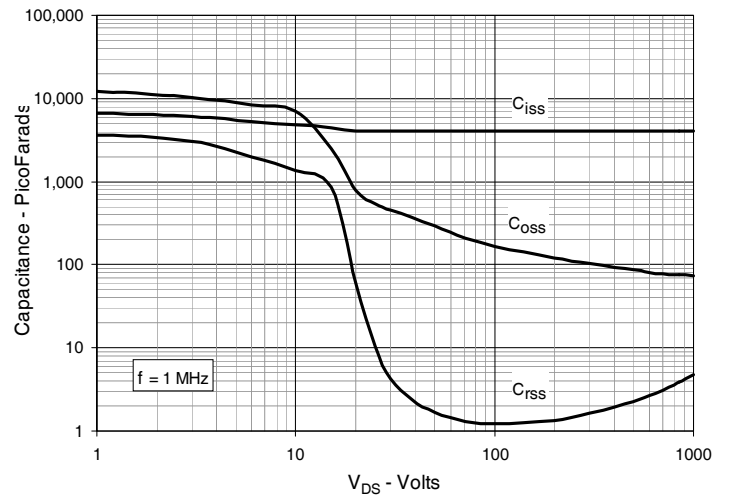

Fig. 13. Output Capacitance Stored Energy

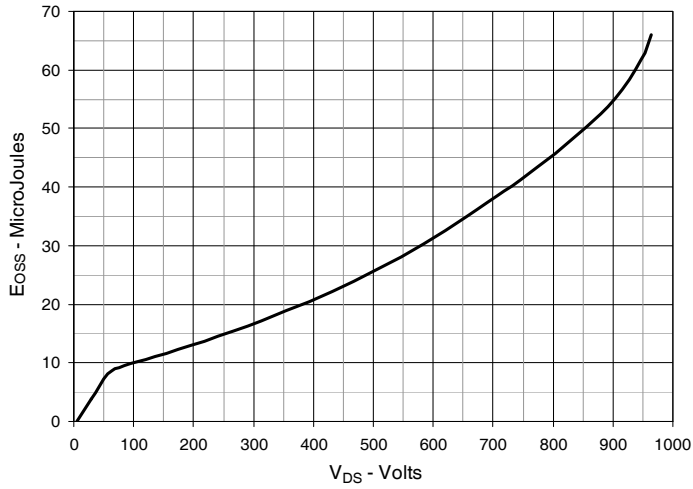

Fig. 14. Forward-Bias Safe Operating Area

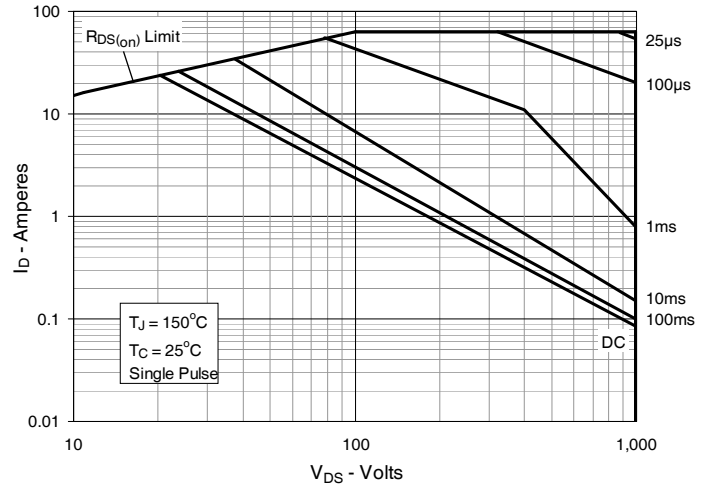
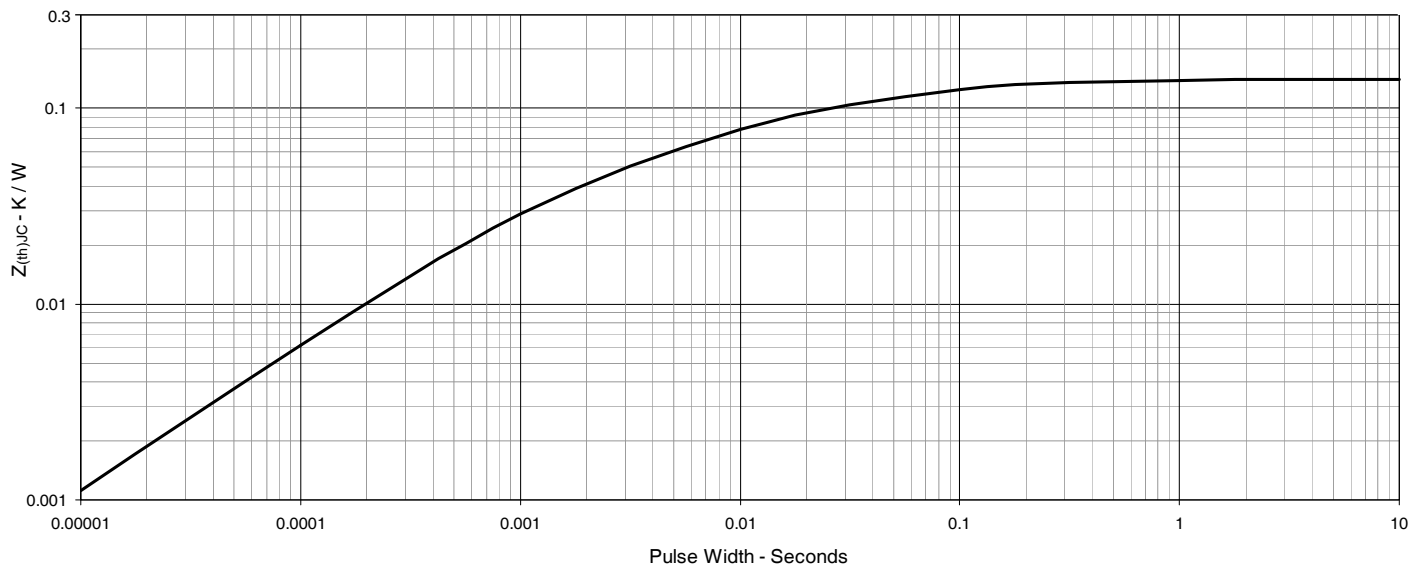
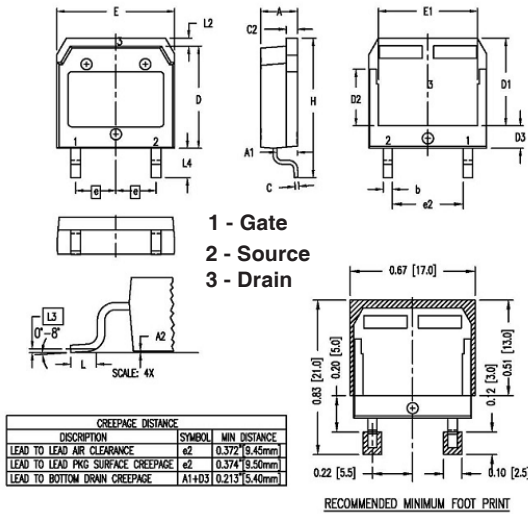

Fig. 15. Maximum Transient Thermal Impedance



### TO-268HV Outline



| SYM  | INCHES   |      | MILLIMETER |       |
|------|----------|------|------------|-------|
|      | MIN      | MAX  | MIN        | MAX   |
| A    | .193     | .201 | 4.90       | 5.10  |
| A1   | .106     | .114 | 2.70       | 2.90  |
| A2   | .001     | .010 | 0.02       | 0.25  |
| b    | .045     | .057 | 1.15       | 1.45  |
| C    | .016     | .026 | 0.40       | 0.65  |
| C2   | .057     | .063 | 1.45       | 1.60  |
| D    | .543     | .551 | 13.80      | 14.00 |
| D1   | .465     | .476 | 11.80      | 12.10 |
| D2   | .295     | .307 | 7.50       | 7.80  |
| D3   | .114     | .126 | 2.90       | 3.20  |
| E    | .624     | .632 | 15.85      | 16.05 |
| E1   | .524     | .535 | 13.30      | 13.60 |
| e    | .215 BSC |      | 5.45 BSC   |       |
| (e2) | .374     | .386 | 9.50       | 9.80  |
| H    | .736     | .752 | 18.70      | 19.10 |
| L    | .067     | .079 | 1.70       | 2.00  |
| L2   | .039     | .045 | 1.00       | 1.15  |
| L3   | .010 BSC |      | 0.25 BSC   |       |
| L4   | .150     | .161 | 3.80       | 4.10  |

- NOTE:
1. This drawing meets all dimensions requirement of JEDEC outlines TO-268AA except L dimension.
  2. All metal surface are matte pure tin plated except trimmed area.
  3. [L3] is Gauge plane to measure L.
  4. These dimension do not include mold flash and they will not exceed 0.005[0.13] per side.

### TO-247 Outline

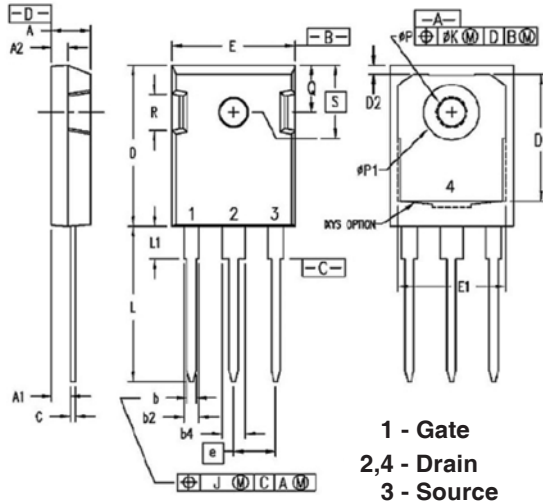

| SYM | INCHES   |      | MILLIMETERS |       |
|-----|----------|------|-------------|-------|
|     | MIN      | MAX  | MIN         | MAX   |
| A   | .190     | .205 | 4.83        | 5.21  |
| A1  | .090     | .100 | 2.29        | 2.54  |
| A2  | .075     | .085 | 1.91        | 2.16  |
| b   | .045     | .055 | 1.14        | 1.40  |
| b2  | .075     | .087 | 1.91        | 2.20  |
| b4  | .115     | .126 | 2.92        | 3.20  |
| C   | .024     | .031 | 0.61        | 0.80  |
| D   | .819     | .840 | 20.80       | 21.34 |
| D1  | .650     | .690 | 16.51       | 17.53 |
| D2  | .035     | .050 | 0.89        | 1.27  |
| E   | .620     | .635 | 15.75       | 16.13 |
| E1  | .545     | .565 | 13.84       | 14.35 |
| e   | .215 BSC |      | 5.45 BSC    |       |
| J   | --       | .010 | --          | 0.25  |
| K   | --       | .025 | --          | 0.64  |
| L   | .780     | .810 | 19.81       | 20.57 |
| L1  | .150     | .170 | 3.81        | 4.32  |
| øP  | .140     | .144 | 3.55        | 3.65  |
| øP1 | .275     | .290 | 6.99        | 7.37  |
| Q   | .220     | .244 | 5.59        | 6.20  |
| R   | .170     | .190 | 4.32        | 4.83  |
| S   | .242 BSC |      | 6.15 BSC    |       |

- NOTE: This drawing will meet all dimensions requirement of JEDEC outlines TO-247 AD (R-PSIP-F3)

### TO-264P Outline

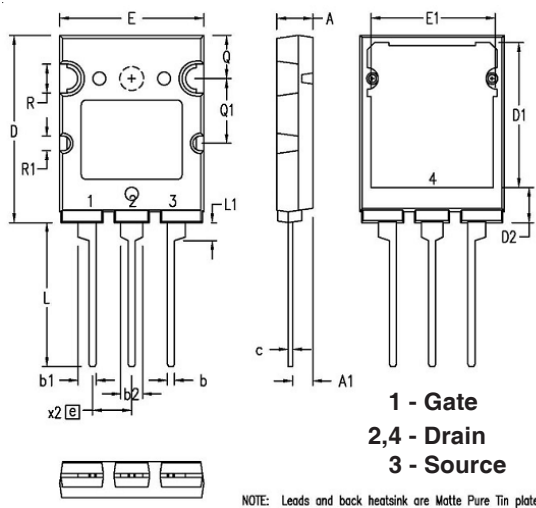

| SYM | INCHES   |       | MILLIMETERS |       |
|-----|----------|-------|-------------|-------|
|     | MIN      | MAX   | MIN         | MAX   |
| A   | .185     | .209  | 4.70        | 5.30  |
| A1  | .102     | .118  | 2.60        | 3.00  |
| b   | .035     | .049  | 0.90        | 1.25  |
| b1  | .091     | .106  | 2.30        | 2.70  |
| b2  | .110     | .126  | 2.80        | 3.20  |
| c   | .020     | .033  | 0.50        | 0.85  |
| D   | 1.012    | 1.035 | 25.70       | 26.30 |
| D1  | .783     | .799  | 19.90       | 20.30 |
| D2  | .185     | .205  | 4.70        | 5.20  |
| E   | .776     | .799  | 19.70       | 20.30 |
| E1  | .661     | .677  | 16.80       | 17.20 |
| e   | .215 BSC |       | 5.46 BSC    |       |
| L   | .768     | .807  | 19.50       | 20.50 |
| L1  | .091     | .106  | 2.30        | 2.70  |
| Q   | .228     | .244  | 5.80        | 6.20  |
| Q1  | .346     | .362  | 8.80        | 9.20  |
| øR  | .150     | .165  | 3.80        | 4.20  |
| øR1 | .071     | .087  | 1.80        | 2.20  |

