

X-Class HiPerFET™ Power MOSFET

IXFT32N100XHV IXFH32N100X IXFK32N100X

$V_{DSS} = 1000V$
 $I_{D25} = 32A$
 $R_{DS(on)} \leq 220m\Omega$

N-Channel Enhancement Mode
Avalanche Rated

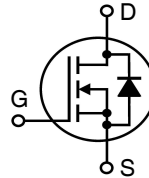

TO-268HV
(IXFT..HV)

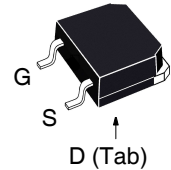

TO-247
(IXFH)

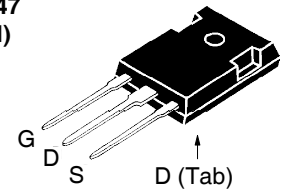

TO-264
(IXFK)

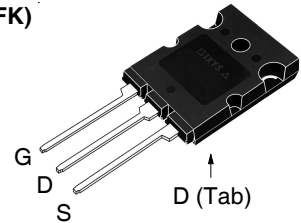

G = Gate D = Drain
S = Source Tab = Drain

Symbol	Test Conditions	Maximum Ratings	
V_{DSS}	$T_J = 25^\circ C$ to $150^\circ C$	1000	V
V_{DGR}	$T_J = 25^\circ C$ to $150^\circ C$, $R_{GS} = 1M\Omega$	1000	V
V_{GSS}	Continuous	± 30	V
V_{GSM}	Transient	± 40	V
I_{D25}	$T_C = 25^\circ C$	32	A
I_{DM}	$T_C = 25^\circ C$, Pulse Width Limited by T_{JM}	64	A
I_A	$T_C = 25^\circ C$	16	A
E_{AS}	$T_C = 25^\circ C$	2	J
dv/dt	$I_S \leq I_{DM}$, $V_{DD} \leq V_{DSS}$, $T_J \leq 150^\circ C$	50	V/ns
P_D	$T_C = 25^\circ C$	890	W
T_J		-55 ... +150	$^\circ C$
T_{JM}		150	$^\circ C$
T_{stg}		-55 ... +150	$^\circ C$
T_L	Maximum Lead Temperature for Soldering	300	$^\circ C$
T_{SOLD}	1.6 mm (0.062in.) from Case for 10s	260	$^\circ C$
M_d	Mounting Torque (TO-247 & TO-264)	1.13 / 10	Nm/lb.in
Weight	TO-268HV	4	g
	TO-247	6	g
	TO-264	10	g

Symbol	Test Conditions ($T_J = 25^\circ C$, Unless Otherwise Specified)	Characteristic Values		
		Min.	Typ.	Max.
BV_{DSS}	$V_{GS} = 0V$, $I_D = 1mA$	1000		V
$V_{GS(th)}$	$V_{DS} = V_{GS}$, $I_D = 4mA$	3.5		6.0 V
I_{GSS}	$V_{GS} = \pm 30V$, $V_{DS} = 0V$			± 100 nA
I_{DSS}	$V_{DS} = V_{DSS}$, $V_{GS} = 0V$ $T_J = 125^\circ C$			50 μA 3 mA
$R_{DS(on)}$	$V_{GS} = 10V$, $I_D = 0.5 \cdot I_{D25}$, Note 1			220 m Ω

Features

- International Standard Packages
- Low $R_{DS(ON)}$ and Q_G
- Avalanche Rated
- Low Package Inductance

Advantages

- High Power Density
- Easy to Mount
- Space Savings

Applications

- Switch-Mode and Resonant-Mode Power Supplies
- DC-DC Converters
- PFC Circuits
- AC and DC Motor Drives
- Robotics and Servo Controls

Symbol	Test Conditions ($T_J = 25^\circ\text{C}$, Unless Otherwise Specified)	Characteristic Values		
		Min.	Typ.	Max
g_{fs}	$V_{DS} = 20\text{V}$, $I_D = 16\text{A}$, Note 1	14	23	S
R_{Gi}	Gate Input Resistance		0.6	Ω
C_{iss}	} $V_{GS} = 0\text{V}$, $V_{DS} = 25\text{V}$, $f = 1\text{MHz}$		4075	pF
C_{oss}			520	pF
C_{rss}			10	pF
	Effective Output Capacitance			
$C_{o(er)}$	Energy related } $V_{GS} = 0\text{V}$		140	pF
$C_{o(tr)}$	Time related } $V_{DS} = 0.8 \cdot V_{DSS}$		585	pF
	Resistive Switching Times		29	ns
$t_{d(on)}$	} $V_{GS} = 10\text{V}$, $V_{DS} = 0.5 \cdot V_{DSS}$, $I_D = 0.5 \cdot I_{D25}$ $R_G = 2\Omega$ (External)		12	ns
t_r			80	ns
$t_{d(off)}$			12	ns
t_f				
$Q_{g(on)}$	} $V_{GS} = 10\text{V}$, $V_{DS} = 0.5 \cdot V_{DSS}$, $I_D = 0.5 \cdot I_{D25}$		130	nC
Q_{gs}			27	nC
Q_{gd}			70	nC
R_{thJC}				0.14 $^\circ\text{C/W}$
R_{thCS}	TO-247		0.21	$^\circ\text{C/W}$
	TO-264P		0.15	$^\circ\text{C/W}$

Source-Drain Diode

Symbol	Test Conditions ($T_J = 25^\circ\text{C}$, Unless Otherwise Specified)	Characteristic Values		
		Min.	Typ.	Max
I_S	$V_{GS} = 0\text{V}$			32 A
I_{SM}	Repetitive, pulse Width Limited by T_{JM}			128 A
V_{SD}	$I_F = I_S$, $V_{GS} = 0\text{V}$, Note 1			1.4 V
t_{rr}	} $I_F = 16\text{A}$, $-di/dt = 100\text{A}/\mu\text{s}$ $V_R = 100\text{V}$		200	ns
Q_{RM}			1.5	μC
I_{RM}			15	A

Note 1. Pulse test, $t \leq 300\mu\text{s}$, duty cycle, $d \leq 2\%$.

IXYS Reserves the Right to Change Limits, Test Conditions, and Dimensions.

IXYS MOSFETs and IGBTs are covered by one or more of the following U.S. patents:

4,835,592	4,931,844	5,049,961	5,237,481	6,162,665	6,404,065B1	6,683,344	6,727,585	7,005,734B2	7,157,338B2
4,860,072	5,017,508	5,063,307	5,381,025	6,259,123B1	6,534,343	6,710,405B2	6,759,692	7,063,975B2	
4,881,106	5,034,796	5,187,117	5,486,715	6,306,728B1	6,583,505	6,710,463	6,771,478B2	7,071,537	

Fig. 1. Output Characteristics @ $T_J = 25^\circ\text{C}$

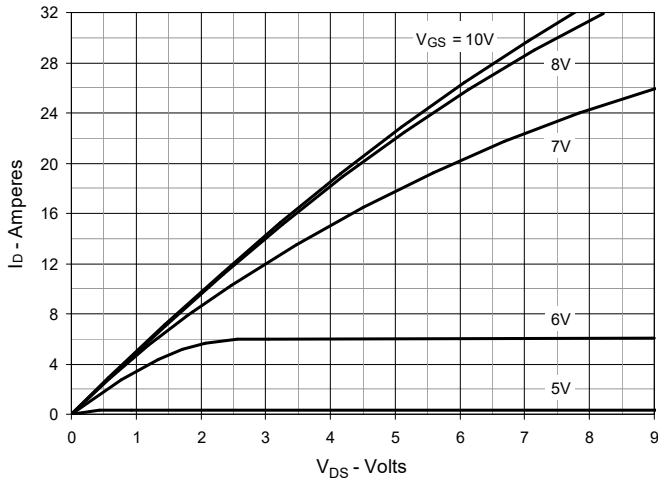

Fig. 2. Extended Output Characteristics @ $T_J = 25^\circ\text{C}$

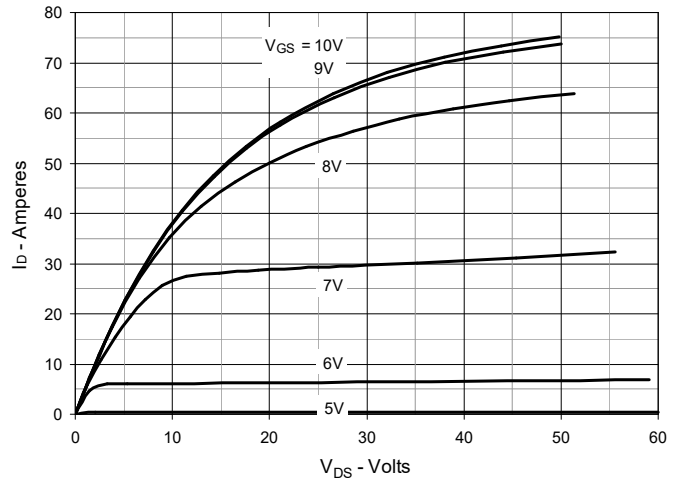

Fig. 3. Output Characteristics @ $T_J = 125^\circ\text{C}$

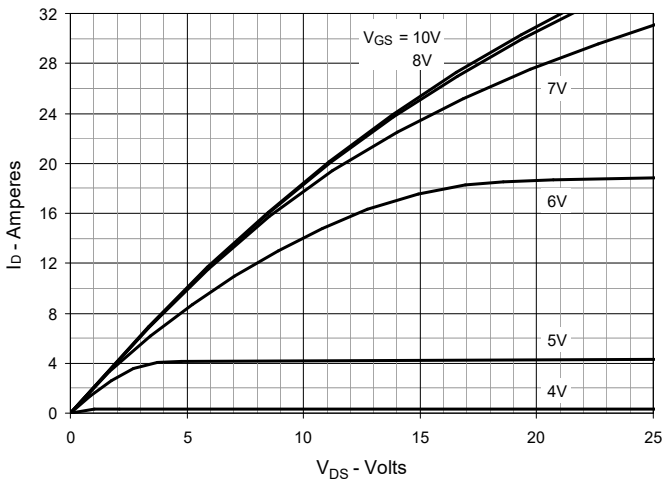

Fig. 4. $R_{DS(on)}$ Normalized to $I_D = 16A$ Value vs. Junction Temperature

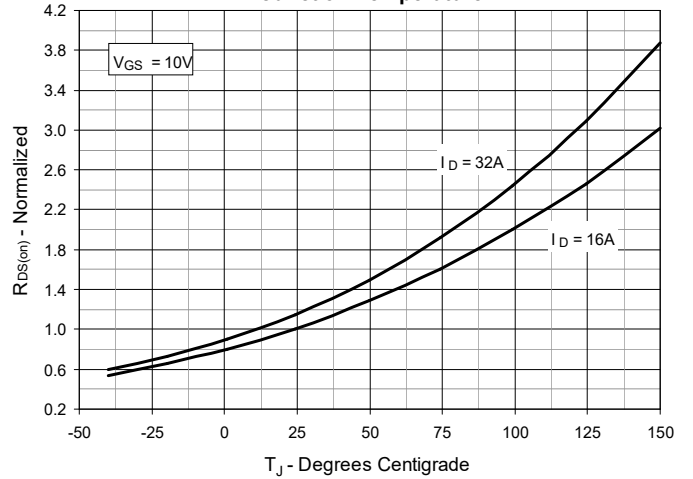

Fig. 5. $R_{DS(on)}$ Normalized to $I_D = 16A$ Value vs. Drain Current

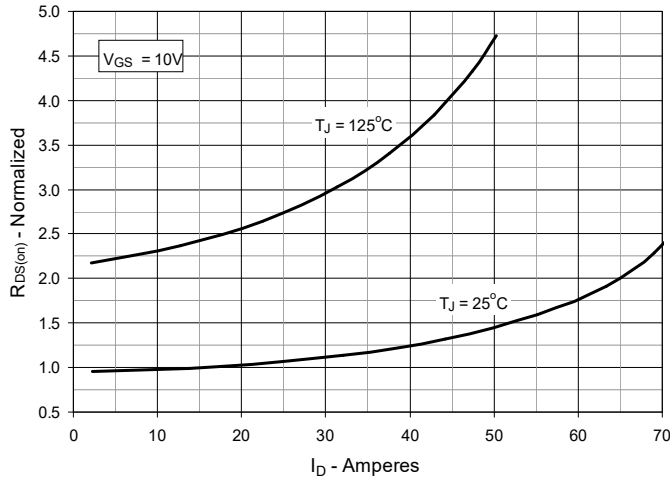

Fig. 6. Normalized Breakdown & Threshold Voltages vs. Junction Temperature

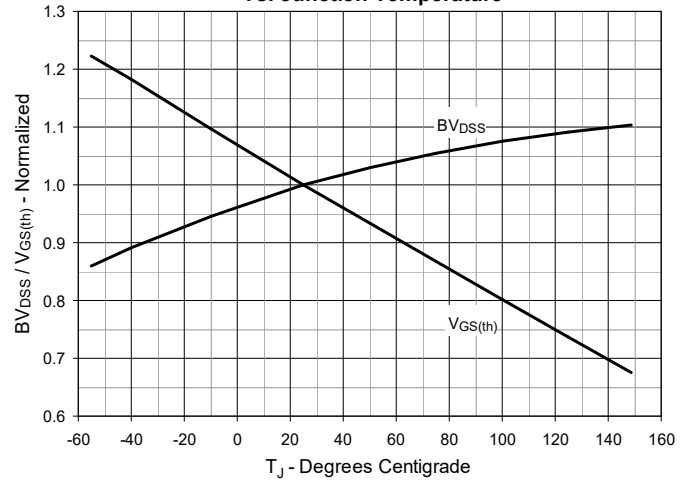

Fig. 7. Maximum Drain Current vs. Case Temperature

Fig. 8. Input Admittance

Fig. 9. Transconductance

Fig. 10. Forward Voltage Drop of Intrinsic Diode

Fig. 11. Gate Charge

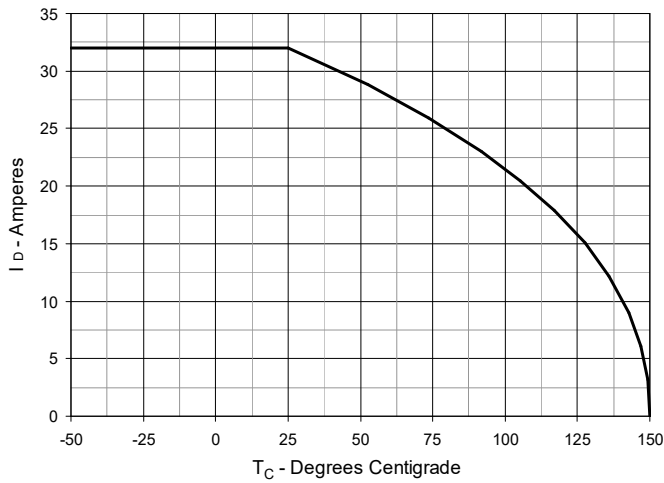
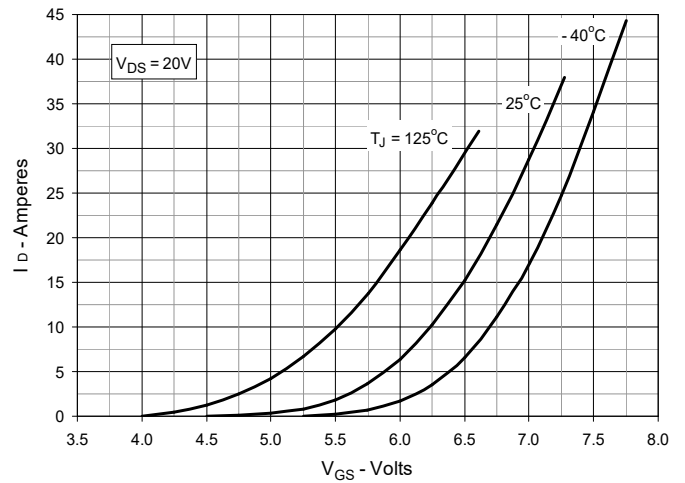
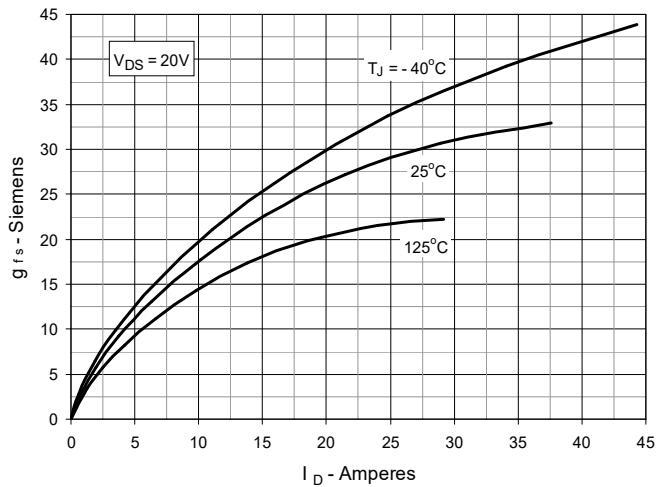
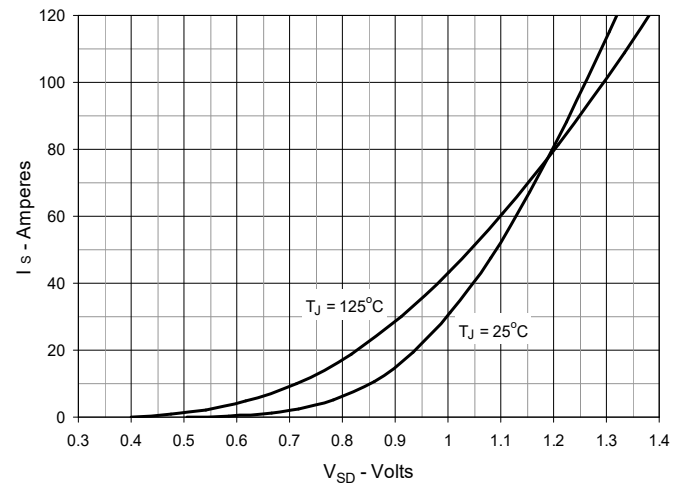
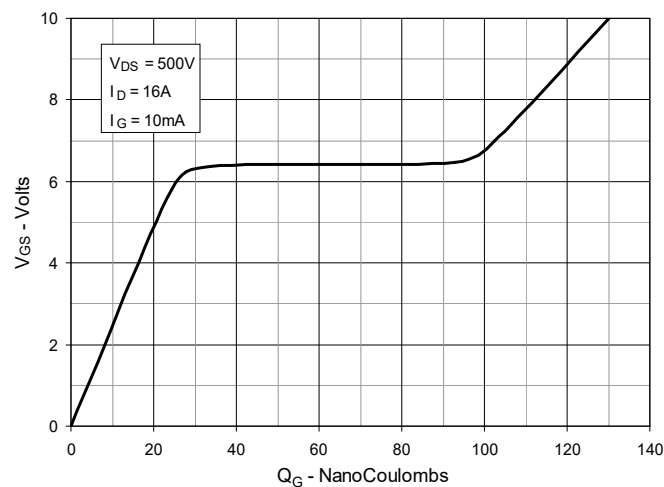
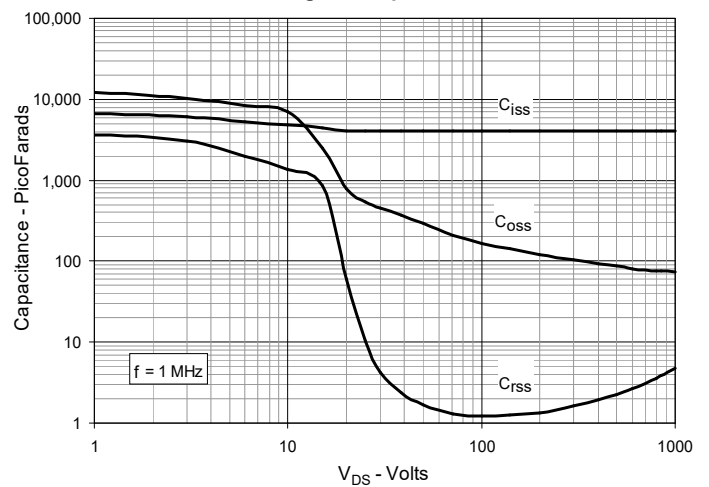
Fig. 12. Capacitance

Fig. 13. Output Capacitance Stored Energy

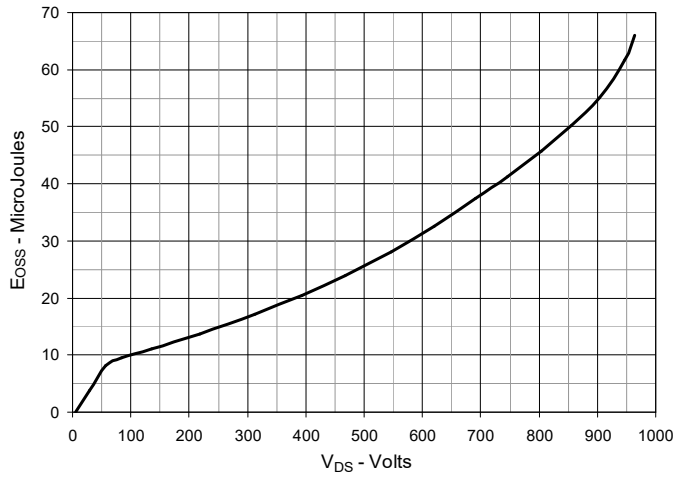

Fig. 14. Forward-Bias Safe Operating Area

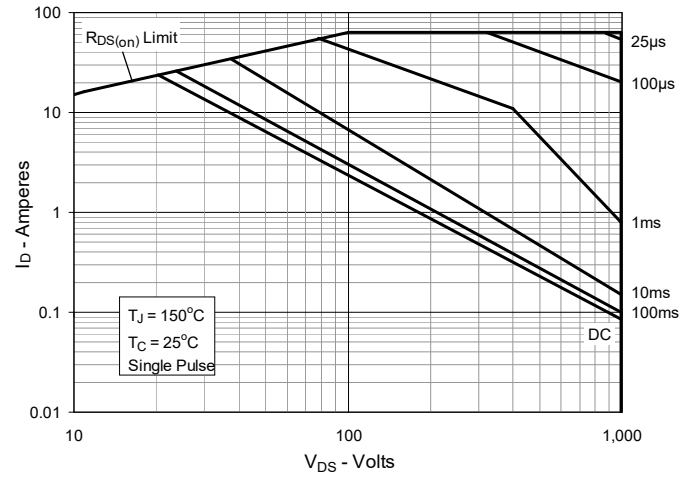
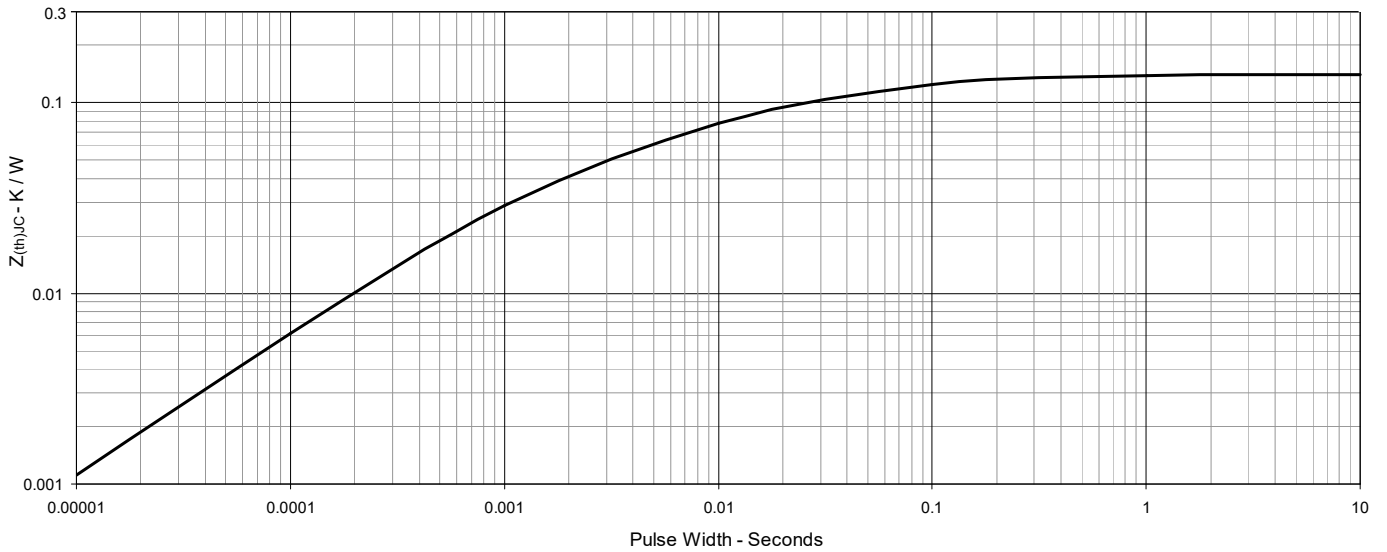
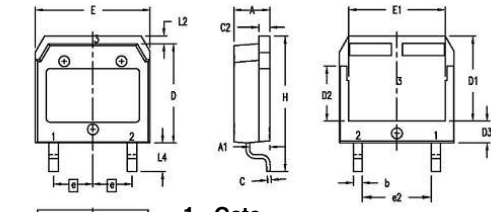

Fig. 15. Maximum Transient Thermal Impedance



TO-268HV Outline



- 1 - Gate
- 2 - Source
- 3 - Drain

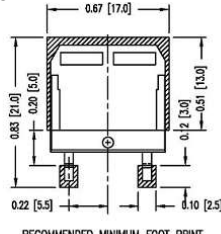
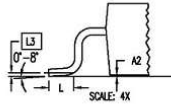

RECOMMENDED MINIMUM FOOT PRINT

CREEPAGE DISTANCE			
DESCRIPTION	SYMBOL	MIN	DISTANCE
LEAD TO LEAD AIR CLEARANCE	e2	0.372	9.45mm
LEAD TO LEAD PKG SURFACE CREEPAGE	e2	0.374	9.50mm
LEAD TO BOTTOM DRAIN CREEPAGE	A1+D3	0.213	5.40mm

SYM	INCHES		MILLIMETER	
	MIN	MAX	MIN	MAX
A	.193	.201	4.90	5.10
A1	.106	.114	2.70	2.90
A2	.001	.010	0.02	0.25
b	.045	.057	1.15	1.45
C	.016	.026	0.40	0.65
C2	.057	.063	1.45	1.60
D	.543	.551	13.80	14.00
D1	.465	.476	11.80	12.10
D2	.295	.307	7.50	7.80
D3	.114	.126	2.90	3.20
E	.624	.632	15.85	16.05
E1	.524	.535	13.30	13.60
e	.215	BSC	5.45	BSC
(e2)	.374	.386	9.50	9.80
H	.736	.752	18.70	19.10
L	.067	.079	1.70	2.00
L2	.039	.045	1.00	1.15
L3	.010	BSC	0.25	BSC
L4	.150	.161	3.80	4.10

- NOTE:
1. This drawing meets all dimensions requirement of JEDEC outlines TO-268AA except L dimension.
 2. All metal surface are matte pure tin plated except trimmed area.
 3. [L3] is Gauge plane to measure L.
 4. These dimension do not include mold flash and they will not exceed 0.005[0.13] per side.

TO-247 Outline

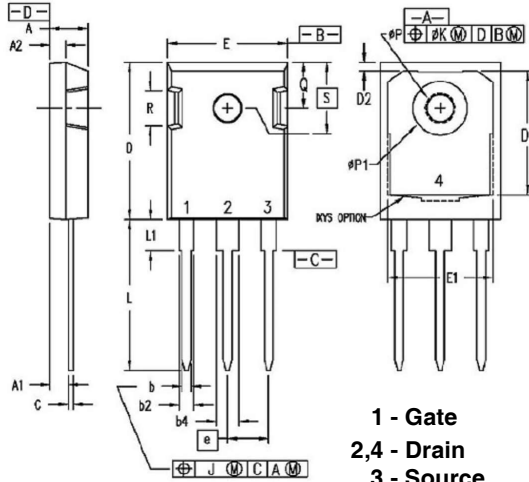

- 1 - Gate
- 2,4 - Drain
- 3 - Source

SYM	INCHES		MILLIMETERS		
	MIN	MAX	MIN	MAX	
A	.190	.205	4.83	5.21	
A1	.090	.100	2.29	2.54	
A2	.075	.085	1.91	2.16	
b	.045	.055	1.14	1.40	
b2	.075	.087	1.91	2.20	
b4	.115	.126	2.92	3.20	
C	.024	.031	0.61	0.80	
D	.819	.840	20.80	21.34	
D1	.650	.690	16.51	17.53	
D2	.035	.050	0.89	1.27	
E	.620	.635	15.75	16.13	
E1	.545	.565	13.84	14.35	
e	.215	BSC	5.45	BSC	
J	--	.010	--	0.25	
K	--	.025	--	0.64	
L	.780	.810	19.81	20.57	
L1	.150	.170	3.81	4.32	
øP	.140	.144	3.55	3.65	
øP1	.275	.290	6.99	7.37	
Q	.220	.244	5.59	6.20	
R	.170	.190	4.32	4.83	
S		.242	BSC	6.15	BSC

- NOTE: This drawing will meet all dimensions requirement of JEDEC outlines TO-247 AD (R-PSIP-F3)

TO-264 Outline

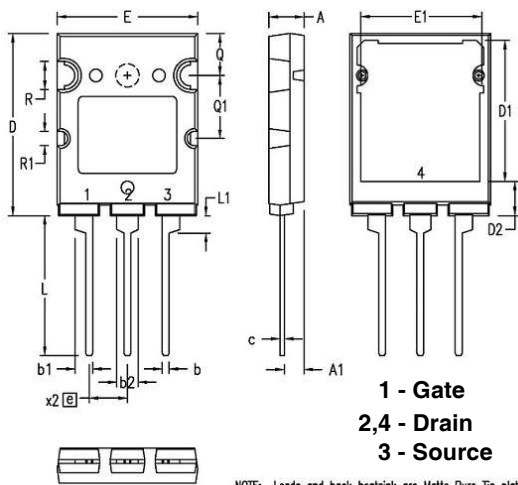

- 1 - Gate
- 2,4 - Drain
- 3 - Source

NOTE: Leads and back heatsink are Matte Pure Tin plated.

SYM	INCHES		MILLIMETERS	
	MIN	MAX	MIN	MAX
A	.185	.209	4.70	5.30
A1	.102	.118	2.60	3.00
b	.035	.049	0.90	1.25
b1	.091	.106	2.30	2.70
b2	.110	.126	2.80	3.20
c	.020	.033	0.50	0.85
D	1.012	1.035	25.70	26.30
D1	.783	.799	19.90	20.30
D2	.185	.205	4.70	5.20
E	.776	.799	19.70	20.30
E1	.661	.677	16.80	17.20
e	.215	BSC	5.46	BSC
L	.768	.807	19.50	20.50
L1	.091	.106	2.30	2.70
Q	.228	.244	5.80	6.20
Q1	.346	.362	8.80	9.20
øR	.150	.165	3.80	4.20
øR1	.071	.087	1.80	2.20



Disclaimer Notice - Information furnished is believed to be accurate and reliable. However, users should independently evaluate the suitability of and test each product selected for their own applications. Littelfuse products are not designed for, and may not be used in, all applications. Read complete Disclaimer Notice at www.littelfuse.com/disclaimer-electronics.
