

Polar™ Power MOSFET

N-Channel Enhancement Mode
Avalanche Rated

IXTU4N60P
~~IXTY4N60P~~
~~IXTA4N60P~~
~~IXTP4N60P~~

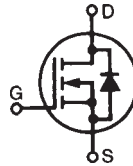

$V_{DSS} = 600V$
 $I_{D25} = 4A$
 $R_{DS(on)} \leq 2\Omega$

TO-251 (IXTU)

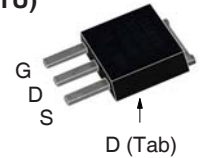

TO-252 (IXTY)

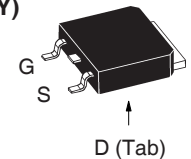

TO-263 (IXTA)

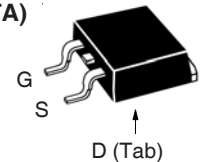

TO-220 (IXTP)

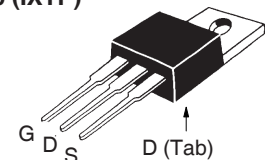

G = Gate D = Drain
S = Source Tab = Drain

Symbol	Test Conditions	Maximum Ratings	
V_{DSS}	$T_J = 25^\circ C$ to $150^\circ C$	600	V
V_{DGR}	$T_J = 25^\circ C$ to $150^\circ C$, $R_{GS} = 1M\Omega$	600	V
V_{GSS}	Continuous	± 30	V
V_{GSM}	Transient	± 40	V
I_{D25}	$T_C = 25^\circ C$	4	A
I_{DM}	$T_C = 25^\circ C$, Pulse Width Limited by T_{JM}	10	A
I_A	$T_C = 25^\circ C$	4	A
E_{AS}	$T_C = 25^\circ C$	150	mJ
dv/dt	$I_S \leq I_{DM}$, $V_{DD} \leq V_{DSS}$, $T_J \leq 150^\circ C$	10	V/ns
P_D	$T_C = 25^\circ C$	90	W
T_J		-55 ... +150	$^\circ C$
T_{JM}		150	$^\circ C$
T_{stg}		-55 ... +150	$^\circ C$
T_L	Maximum Lead Temperature for Soldering	300	$^\circ C$
T_{SOLD}	1.6 mm (0.062in.) from Case for 10s	260	$^\circ C$
F_C	Mounting Force (TO-263 & TO-251)	10..65 / 2.2..14.6	N/lb
M_d	Mounting Torque (TO-220)	1.13 / 10	Nm/lb.in
Weight	TO-251	0.40	g
	TO-252	0.35	g
	TO-263	2.50	g
	TO-220	3.00	g

Symbol	Test Conditions ($T_J = 25^\circ C$, Unless Otherwise Specified)	Characteristic Values		
		Min.	Typ.	Max.
BV_{DSS}	$V_{GS} = 0V$, $I_D = 250\mu A$	600		V
$V_{GS(th)}$	$V_{DS} = V_{GS}$, $I_D = 100\mu A$	3.0		5.5 V
I_{GSS}	$V_{GS} = \pm 30V$, $V_{DS} = 0V$			± 100 nA
I_{DSS}	$V_{DS} = V_{DSS}$, $V_{GS} = 0V$ $T_J = 125^\circ C$			1 μA 50 μA
$R_{DS(on)}$	$V_{GS} = 10V$, $I_D = 0.5 \cdot I_{D25}$, Note 1			2 Ω

Features

- International Standard Packages
- Low Q_G
- Avalanche Rated
- Low Package Inductance
- Fast Intrinsic Rectifier

Advantages

- High Power Density
- Easy to Mount
- Space Savings

Applications

- DC-DC Converters
- Switch-Mode and Resonant-Mode Power Supplies
- AC and DC Motor Drives
- Discharge Circuits in Lasers, Spark Igniters, RF Generators
- High Voltage Pulse Power Applications

Symbol	Test Conditions ($T_J = 25^\circ\text{C}$, Unless Otherwise Specified)	Characteristic Values		
		Min.	Typ.	Max
g_{fs}	$V_{DS} = 10\text{V}$, $I_D = 0.5 \cdot I_{D25}$, Note 1	2.8	4.6	S
C_{iss}	$V_{GS} = 0\text{V}$, $V_{DS} = 25\text{V}$, $f = 1\text{MHz}$		635	pF
C_{oss}			65	pF
C_{rss}			5.7	pF
$Q_{g(on)}$	$V_{GS} = 10\text{V}$, $V_{DS} = 0.5 \cdot V_{DSS}$, $I_D = 0.5 \cdot I_{D25}$		13	nC
Q_{gs}			6	nC
Q_{gd}			4	nC
$t_{d(on)}$	Resistive Switching Times $V_{GS} = 10\text{V}$, $V_{DS} = 0.5 \cdot V_{DSS}$, $I_D = 0.5 \cdot I_{D25}$ $R_G = 30\Omega$ (External)		25	ns
t_r			10	ns
$t_{d(off)}$			50	ns
t_f			20	ns
R_{thJC}	TO-220			1.4 $^\circ\text{C/W}$
R_{thCS}		0.50		$^\circ\text{C/W}$

Source-Drain Diode

Symbol	Test Conditions ($T_J = 25^\circ\text{C}$, Unless Otherwise Specified)	Characteristic Values		
		Min.	Typ.	Max
I_S	$V_{GS} = 0\text{V}$			4 A
I_{SM}	Repetitive, Pulse Width Limited by T_{JM}			12 A
V_{SD}	$I_F = I_S$, $V_{GS} = 0\text{V}$, Note 1			1.5 V
t_{rr}	$I_F = 4\text{A}$, $-di/dt = 100\text{A}/\mu\text{s}$, $V_R = 100\text{V}$		500	ns

Note 1. Pulse test, $t \leq 300\mu\text{s}$, duty cycle, $d \leq 2\%$.

IXYS Reserves the Right to Change Limits, Test Conditions, and Dimensions.

IXYS MOSFETs and IGBTs are covered by one or more of the following U.S. patents:	4,835,592	4,931,844	5,049,961	5,237,481	6,162,665	6,404,065B1	6,683,344	6,727,585	7,005,734B2	7,157,338B2
	4,860,072	5,017,508	5,063,307	5,381,025	6,259,123B1	6,534,343	6,710,405B2	6,759,692	7,063,975B2	
	4,881,106	5,034,796	5,187,117	5,486,715	6,306,728B1	6,583,505	6,710,463	6,771,478B2	7,071,537	

Fig. 1. Output Characteristics @ $T_J = 25^\circ\text{C}$

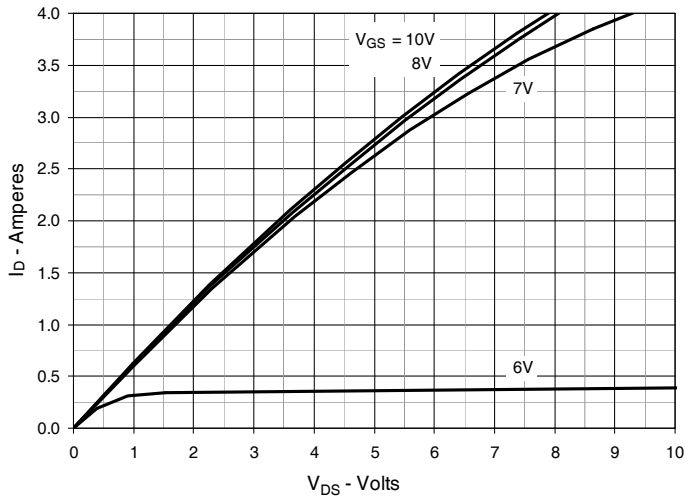

Fig. 2. Extended Output Characteristics @ $T_J = 25^\circ\text{C}$

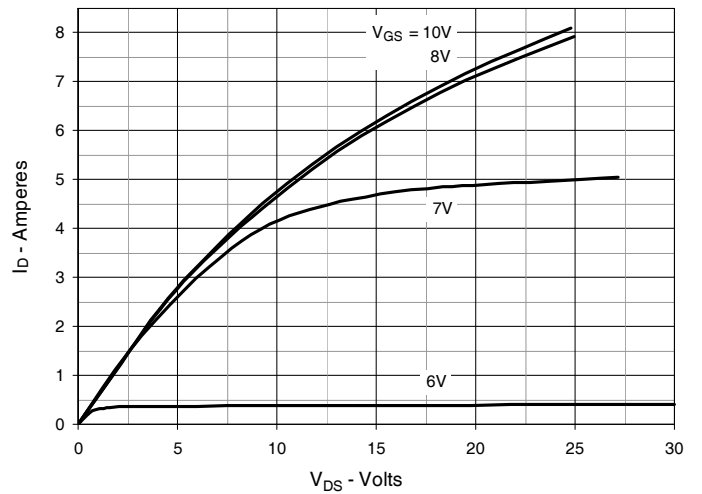

Fig. 3. Output Characteristics @ $T_J = 125^\circ\text{C}$

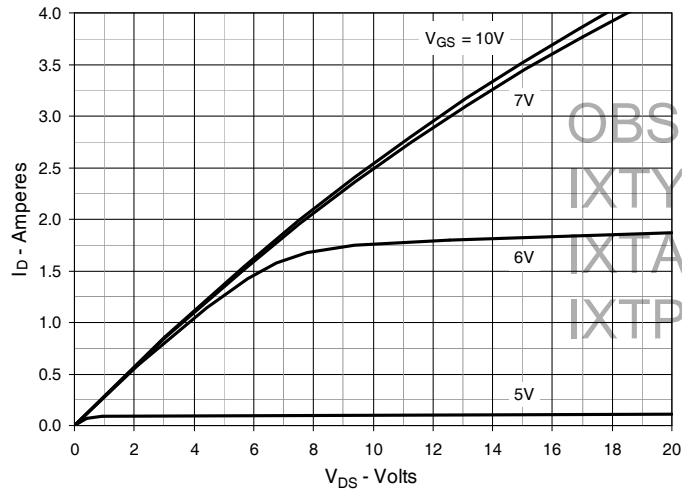

Fig. 4. $R_{DS(on)}$ Normalized to $I_D = 2A$ Value vs. Junction Temperature

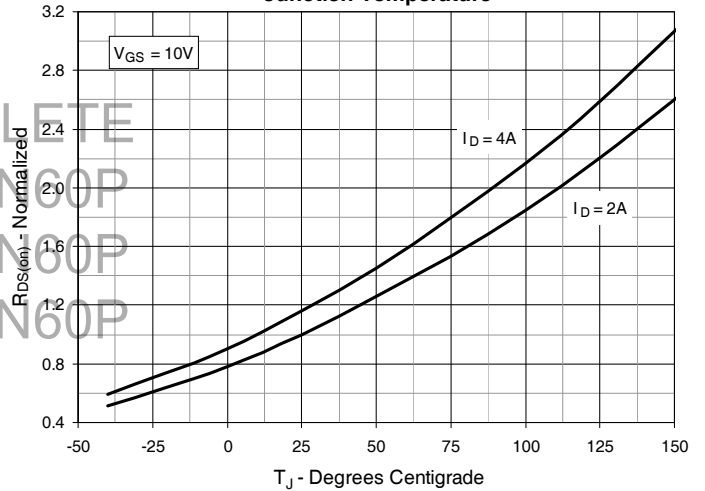

Fig. 5. $R_{DS(on)}$ Normalized to $I_D = 2A$ Value vs. Drain Current

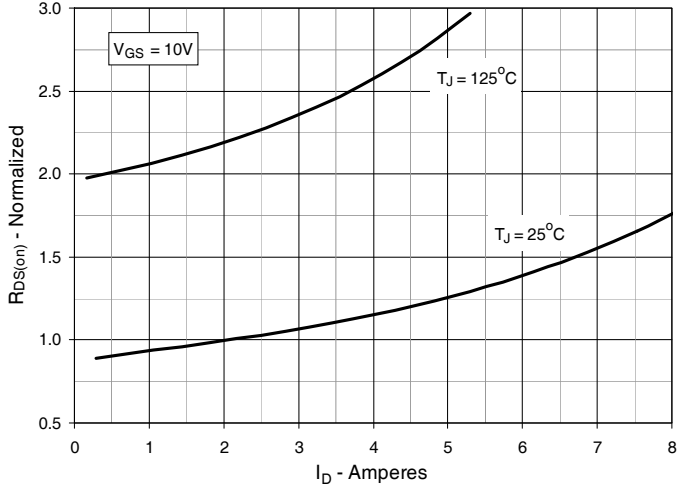

Fig. 6. Maximum Drain Current vs. Case Temperature

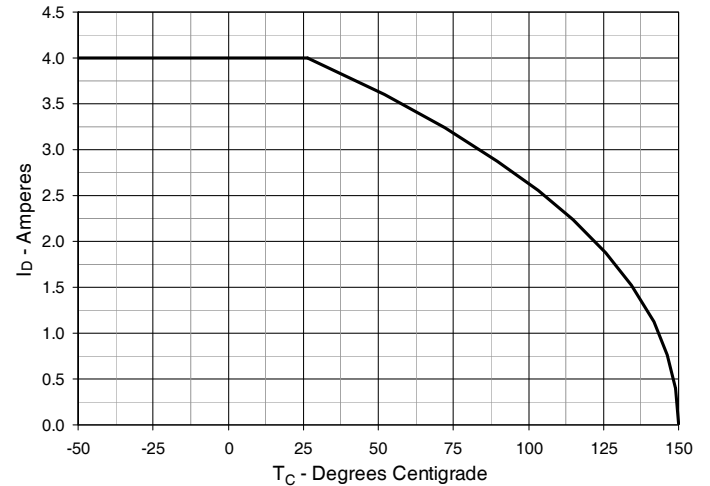

Fig. 7. Input Admittance

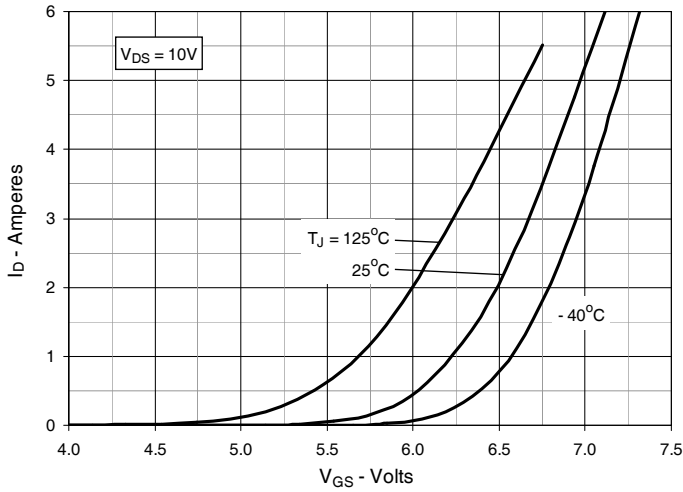

Fig. 8. Transconductance

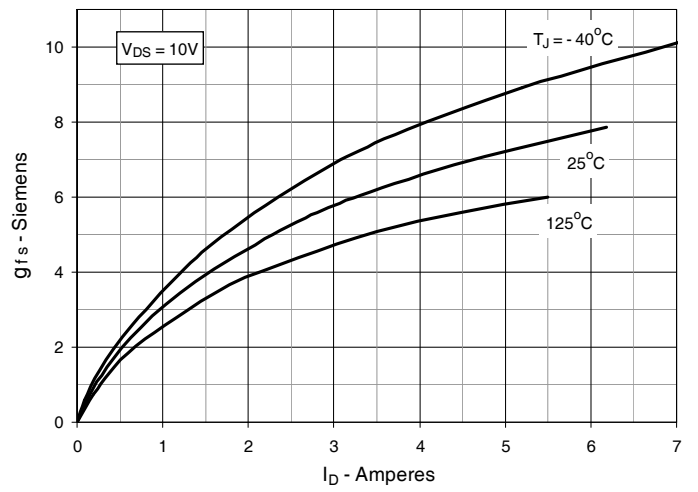

Fig. 9. Forward Voltage Drop of Intrinsic Diode

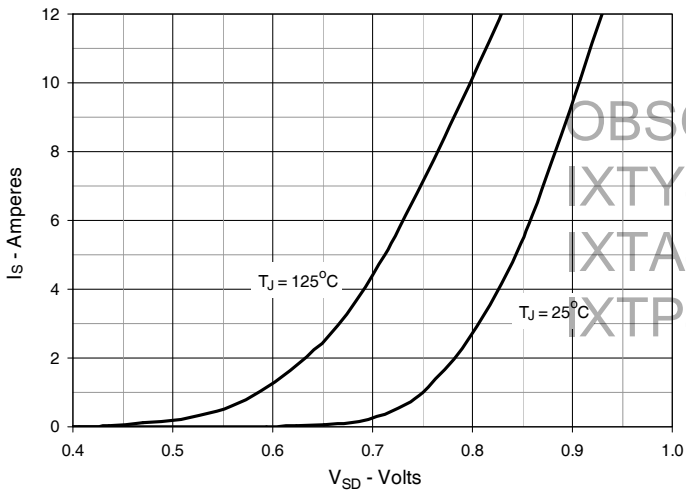

Fig. 10. Gate Charge

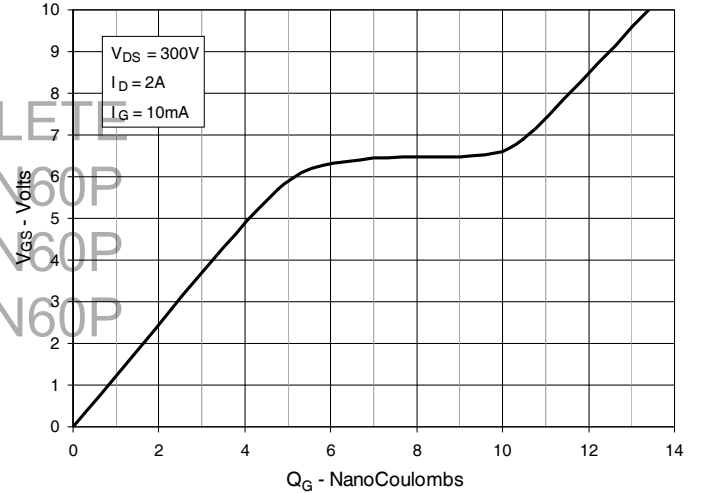

Fig. 11. Capacitance

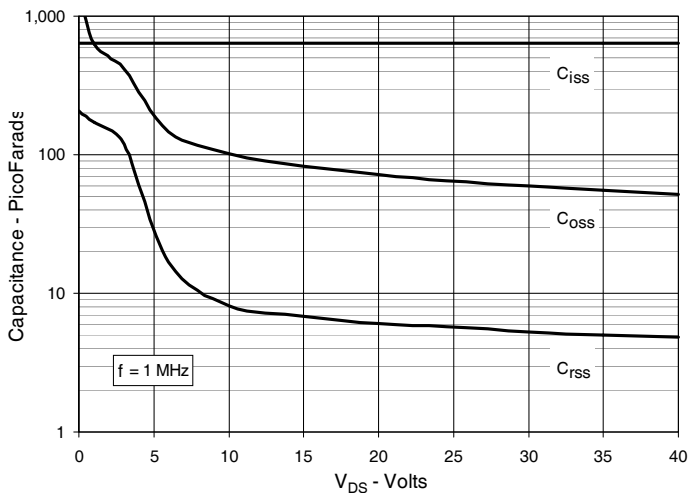
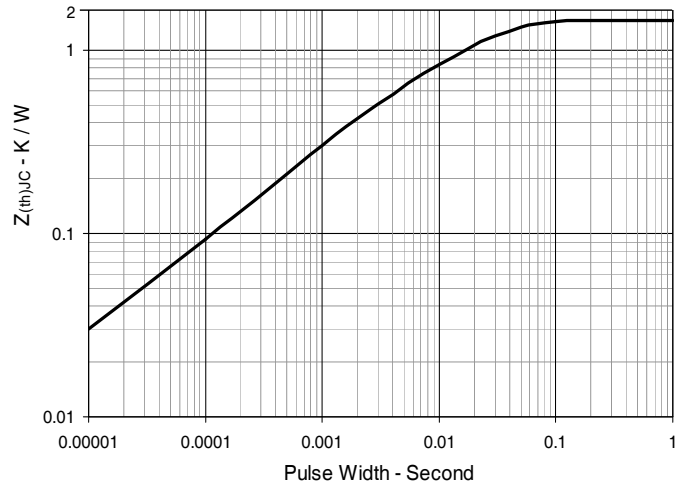
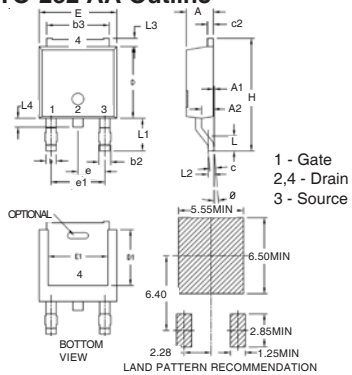

Fig. 12. Maximum Transient Thermal Impedance



TO-252 AA Outline



SYM	INCHES		MILLIMETERS	
	MIN	MAX	MIN	MAX
A	.086	.094	2.19	2.38
A1	0	.005	0	0.12
A2	.038	.046	0.97	1.17
b	.025	.035	0.64	0.89
b2	.030	.045	0.76	1.14
b3	.200	.215	5.08	5.46
c	.018	.024	0.46	0.61
c2	.018	.023	0.46	0.58
D	.235	.245	5.97	6.22
D1	.180	.205	4.57	5.21
E	.250	.265	6.35	6.73
E1	.170	.205	4.32	5.21
e	.090 BSC		2.28 BSC	
e1	.180 BSC		4.57 BSC	
H	.370	.410	9.40	10.42
L	.055	.070	1.40	1.78
L1	.100	.115	2.54	2.92
L2	.020 BSC		0.50 BSC	
L3	.025	.040	0.64	1.02
L4	.025	.040	0.64	1.02
θ	0°	10°	0°	10°

TO-263 Outline

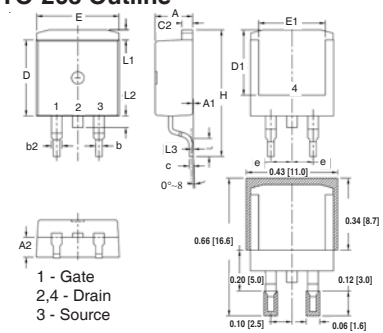

SYM	INCHES		MILLIMETER	
	MIN	MAX	MIN	MAX
A	.170	.185	4.30	4.70
A1	.000	.008	0.00	0.20
A2	.091	.098	2.30	2.50
b	.028	.035	0.70	0.90
b2	.046	.060	1.18	1.52
C	.018	.024	0.45	0.60
C2	.049	.060	1.25	1.52
D	.340	.370	8.63	9.40
D1	.300	.327	7.62	8.30
E	.380	.410	9.65	10.41
E1	.270	.330	6.86	8.38
e	.100 BSC		2.54 BSC	
H	.580	.620	14.73	15.75
L	.075	.105	1.91	2.67
L1	.039	.060	1.00	1.52
L2	.070		1.77	
L3	.010 BSC		0.254 BSC	

TO-220 Outline

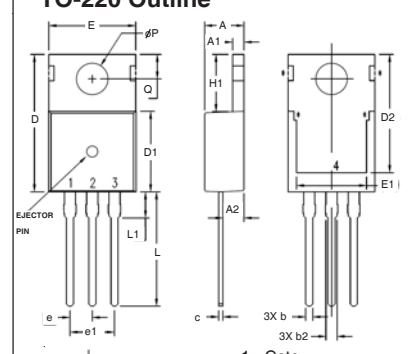

SYM	INCHES		MILLIMETERS	
	MIN	MAX	MIN	MAX
A	.169	.185	4.30	4.70
A1	.047	.055	1.20	1.40
A2	.079	.106	2.00	2.70
b	.024	.039	0.60	1.00
b2	.045	.057	1.15	1.45
c	.014	.026	0.35	0.65
D	.587	.626	14.90	15.90
D1	.335	.370	8.50	9.40
(D2)	.500	.531	12.70	13.50
E	.382	.406	9.70	10.30
(E1)	.283	.323	7.20	8.20
e	.100 BSC		2.54 BSC	
e1	.200 BSC		5.08 BSC	
H1	.244	.268	6.20	6.80
L	.492	.547	12.50	13.90
L1	.110	.154	2.80	3.90
∅P	.134	.150	3.40	3.80
Q	.106	.126	2.70	3.20

TO-251 OUTLINE

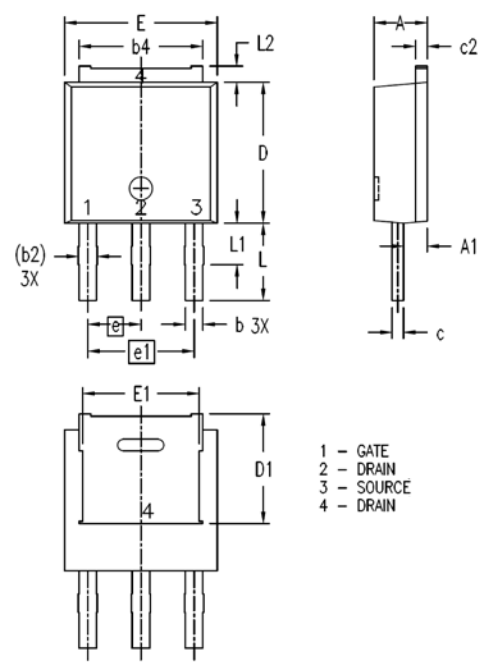

SYM	INCHES		MILLIMETERS	
	MIN	MAX	MIN	MAX
A	.087	.094	2.20	2.40
A1	.032	.048	0.82	1.22
b	.026	.034	0.66	0.86
(b2)	.030	.035	0.76	0.88
b4	.198	.222	5.04	5.64
c	.018	.024	0.45	0.60
c2	.016	.024	0.40	0.60
D	.232	.248	5.90	6.30
(D1)	.179	.195	4.55	4.95
E	.252	.268	6.40	6.80
(E1)	.191	.207	4.85	5.25
e	.090 BSC		2.28 BSC	
e1	.180 BSC		4.57 BSC	
L	.126	.138	3.20	3.50
L1	.063	.079	1.60	2.00
L2	.020	.035	0.50	0.90



Disclaimer Notice - Information furnished is believed to be accurate and reliable. However, users should independently evaluate the suitability of and test each product selected for their own applications. Littelfuse products are not designed for, and may not be used in, all applications. Read complete Disclaimer Notice at www.littelfuse.com/disclaimer-electronics.