

High Voltage Power MOSFET

IXTH1N250

$$V_{DSS} = 2500V$$

$$I_{D25} = 1.5A$$

$$R_{DS(on)} \leq 40\Omega$$

N-Channel Enhancement Mode
Fast Intrinsic Diode

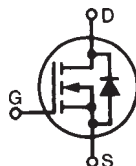

Symbol	Test Conditions	Maximum Ratings	
V_{DSS}	$T_J = 25^\circ\text{C}$ to 150°C	2500	V
V_{DGR}	$T_J = 25^\circ\text{C}$ to 150°C , $R_{GS} = 1M\Omega$	2500	V
V_{GSS}	Continuous	± 20	V
V_{GSM}	Transient	± 30	V
I_{D25}	$T_C = 25^\circ\text{C}$	1.5	A
I_{DM}	$T_C = 25^\circ\text{C}$, Pulse Width Limited by T_{JM}	6	A
P_D	$T_C = 25^\circ\text{C}$	250	W
T_J		- 55 ... +150	$^\circ\text{C}$
T_{JM}		150	$^\circ\text{C}$
T_{stg}		- 55 ... +150	$^\circ\text{C}$
T_L	1.6mm (0.062 in.) From Case for 10s	300	$^\circ\text{C}$
T_{SOLD}	Plastic Body for 10s	260	$^\circ\text{C}$
M_d	Mounting Torque	1.13 / 10	Nm/lb.in.
Weight		6	g

TO-247

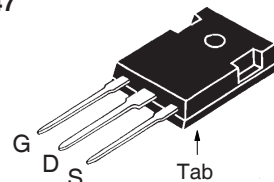

G = Gate D = Drain
S = Source Tab = Drain

Features

- International Standard Package
- Molding Epoxies Meet UL 94 V-0 Flammability Classification
- Fast Intrinsic Diode
- Low Package Inductance

Advantages

- Easy to Mount
- Space Savings
- High Power Density

Applications

- High Voltage Power Supplies
- Capacitor Discharge
- Pulse Circuits

Symbol	Test Conditions ($T_J = 25^\circ\text{C}$, Unless Otherwise Specified)	Characteristic Values		
		Min.	Typ.	Max.
BV_{DSS}	$V_{GS} = 0V$, $I_D = 250\mu\text{A}$	2500		V
$V_{GS(th)}$	$V_{DS} = V_{GS}$, $I_D = 250\mu\text{A}$	2.0		4.0 V
I_{GSS}	$V_{GS} = \pm 20V$, $V_{DS} = 0V$			± 100 nA
I_{DSS}	$V_{DS} = 0.8 \cdot V_{DSS}$, $V_{GS} = 0V$ $T_J = 125^\circ\text{C}$		25	μA μA
$R_{DS(on)}$	$V_{GS} = 10V$, $I_D = 0.5 \cdot I_{D25}$, Note 1			40 Ω

Symbol	Test Conditions ($T_J = 25^\circ\text{C}$, Unless Otherwise Specified)	Characteristic Values		
		Min.	Typ.	Max.
g_{fs}	$V_{DS} = 50\text{V}$, $I_D = 0.5\text{A}$, Note 1	1.0	1.8	mS
C_{iss}	$V_{GS} = 0\text{V}$, $V_{DS} = 25\text{V}$, $f = 1\text{MHz}$		1660	pF
C_{oss}			77	pF
C_{rss}			23	pF
$t_{d(on)}$	Resistive Switching Times $V_{GS} = 10\text{V}$, $V_{DS} = 0.5 \cdot V_{DSS}$, $I_D = 1\text{A}$ $R_G = 5\Omega$ (External)		69	ns
t_r			25	ns
$t_{d(off)}$			132	ns
t_f			39	ns
$Q_{g(on)}$	$V_{GS} = 10\text{V}$, $V_{DS} = 600\text{V}$, $I_D = 0.5\text{A}$		41	nC
Q_{gs}			8	nC
Q_{gd}			16	nC
R_{thJC}			0.50	$^\circ\text{C/W}$
R_{thCS}		0.21		$^\circ\text{C/W}$

Source-Drain Diode

Symbol	Test Conditions ($T_J = 25^\circ\text{C}$, Unless Otherwise Specified)	Characteristic Values		
		Min.	Typ.	Max.
I_S	$V_{GS} = 0\text{V}$			1.5 A
I_{SM}	Repetitive, Pulse Width Limited by T_{JM}			6 A
V_{SD}	$I_F = 1\text{A}$, $V_{GS} = 0\text{V}$, Note 1			1.5 V
t_{rr}	$I_F = 1\text{A}$, $-di/dt = 100\text{A}/\mu\text{s}$, $V_R = 200\text{V}$		2.5	μs

Note 1. Pulse test, $t \leq 300\mu\text{s}$, duty cycle, $d \leq 2\%$.

*Additional provisions for lead to lead voltage isolation are required at $V_{DS} > 1200\text{V}$.

TO-247 (IXTH) Outline

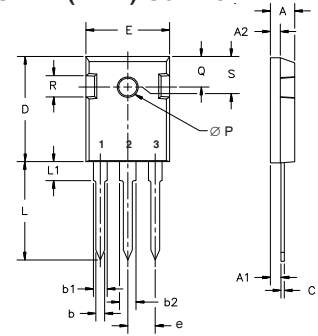

Terminals: 1 - Gate
2 - Drain
3 - Source

Dim.	Millimeter		Inches	
	Min.	Max.	Min.	Max.
A	4.7	5.3	.185	.209
A ₁	2.2	2.54	.087	.102
A ₂	2.2	2.6	.059	.098
b	1.0	1.4	.040	.055
b ₁	1.65	2.13	.065	.084
b ₂	2.87	3.12	.113	.123
C	.4	.8	.016	.031
D	20.80	21.46	.819	.845
E	15.75	16.26	.610	.640
e	5.20	5.72	0.205	0.225
L	19.81	20.32	.780	.800
L1		4.50		.177
ØP	3.55	3.65	.140	.144
Q	5.89	6.40	0.232	0.252
R	4.32	5.49	.170	.216

IXYS Reserves the Right to Change Limits, Test Conditions, and Dimensions.

IXYS MOSFETs and IGBTs are covered by one or more of the following U.S. patents:

4,835,592	4,931,844	5,049,961	5,237,481	6,162,665	6,404,065 B1	6,683,344	6,727,585	7,005,734 B2	7,157,338B2
4,860,072	5,017,508	5,063,307	5,381,025	6,259,123 B1	6,534,343	6,710,405 B2	6,759,692	7,063,975 B2	
4,881,106	5,034,796	5,187,117	5,486,715	6,306,728 B1	6,583,505	6,710,463	6,771,478 B2	7,071,537	

Fig. 1. Output Characteristics @ $T_J = @ 25^\circ\text{C}$

Fig. 2. Output Characteristics @ $T_J = 125^\circ\text{C}$

Fig. 4. $R_{DS(on)}$ Normalized to $I_D = 0.5\text{A}$ Value vs. Junction Temperature

Fig. 3. $R_{DS(on)}$ Normalized to $I_D = 0.5\text{A}$ Value vs. Drain Current

Fig. 5. Maximum Drain Current vs. Case Temperature

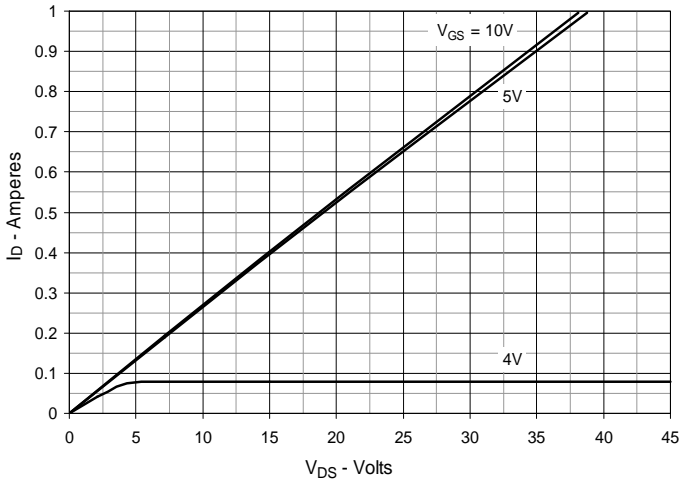
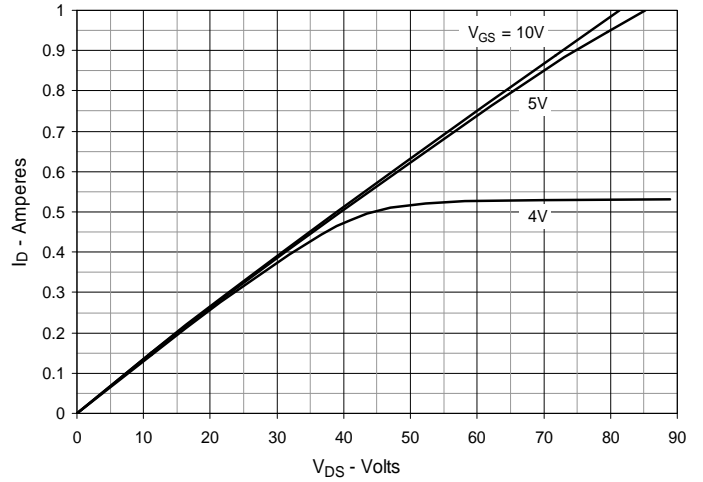
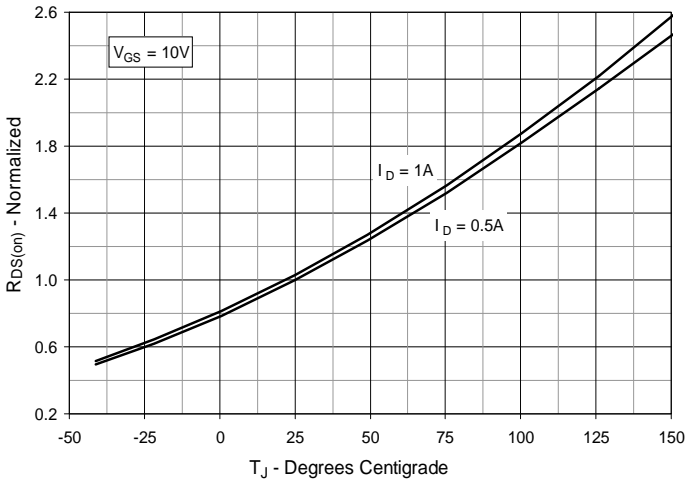
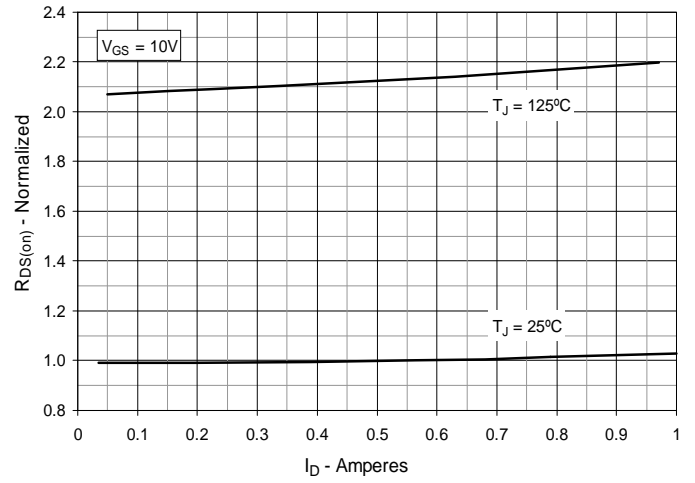
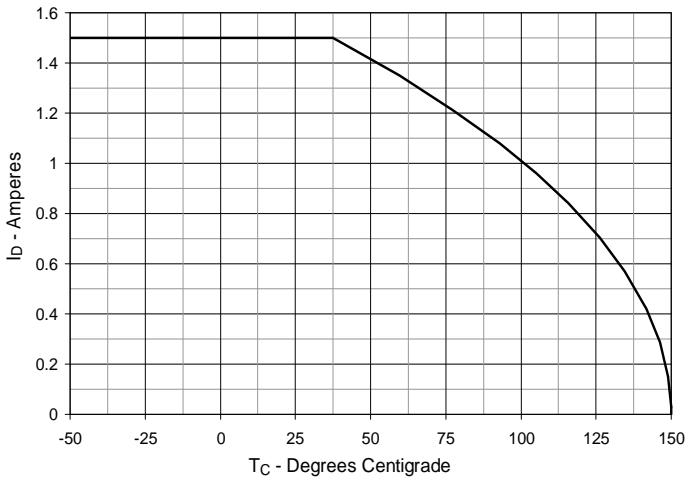
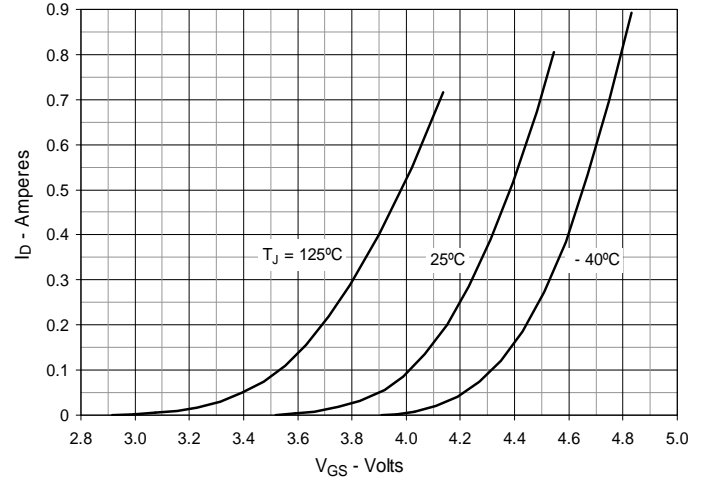
Fig. 6. Input Admittance

Fig. 7. Transconductance

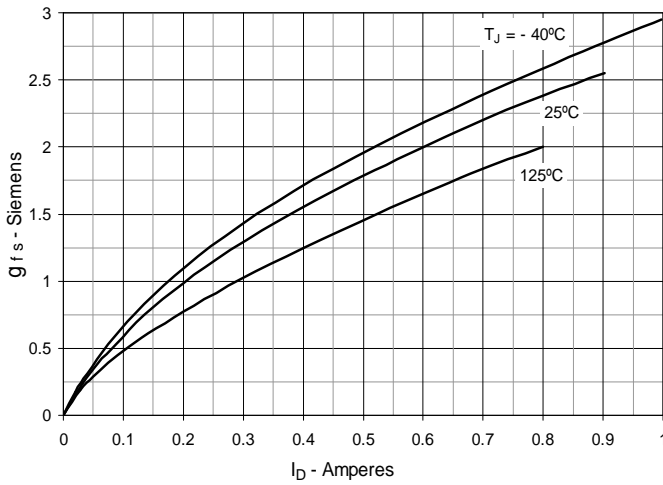

Fig. 8. Forward Voltage Drop of Intrinsic Diode

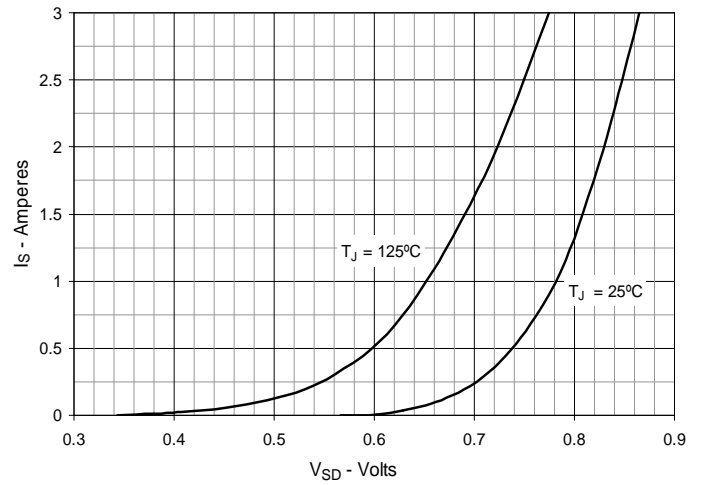

Fig. 9. Gate Charge

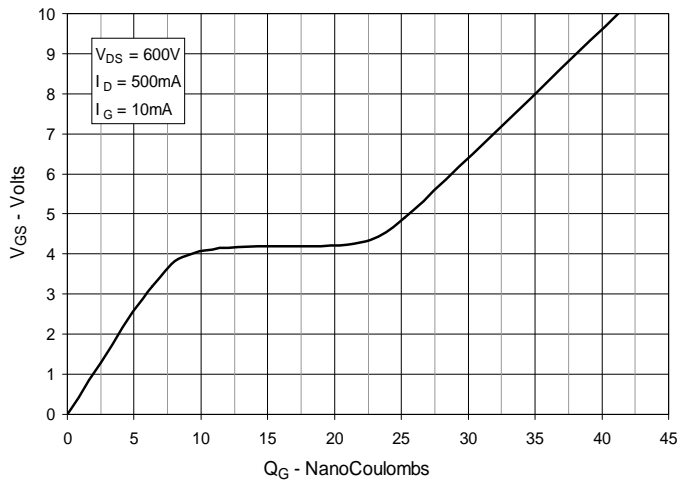

Fig. 10. Capacitance

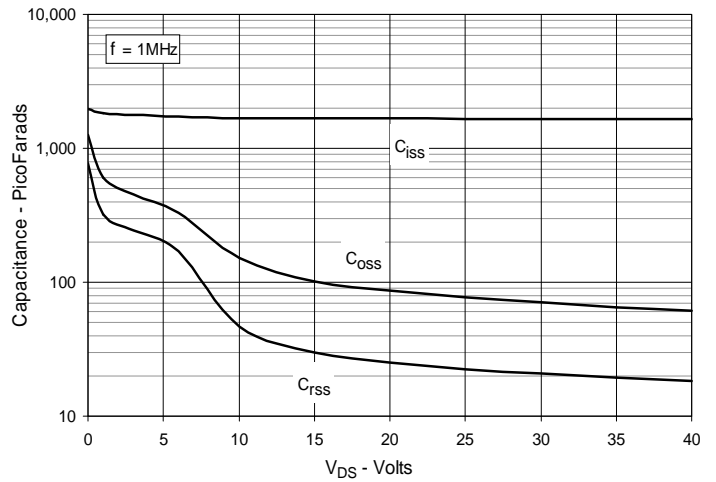

Fig. 11. Forward-Bias Safe Operating Area @ $T_C = 25^\circ\text{C}$

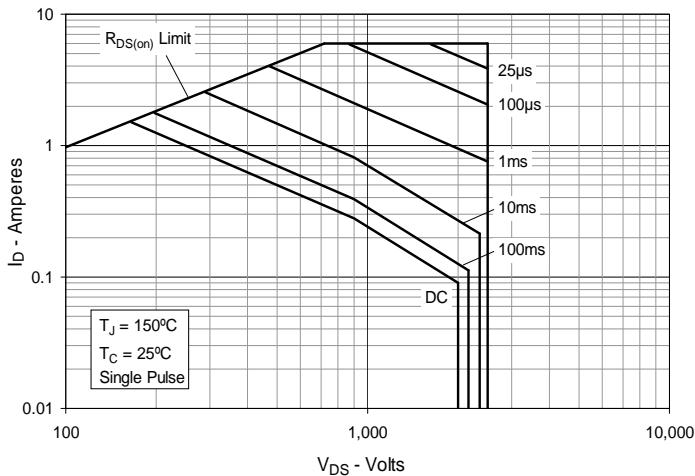

Fig. 12. Forward-Bias Safe Operating Area @ $T_C = 75^\circ\text{C}$

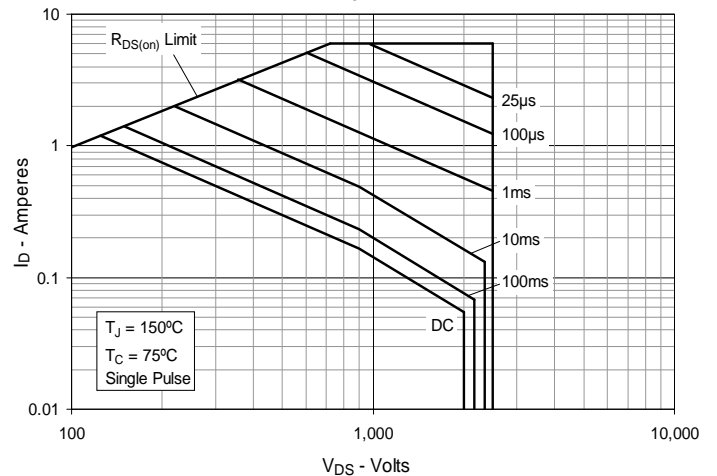

Fig. 13. Maximum Transient Thermal Impedance

