

Polar3™ High Voltage Power MOSFET

IXTF6N200P3

$$V_{DSS} = 2000V$$

$$I_{D25} = 4A$$

$$R_{DS(on)} \leq 4.2\Omega$$

(Electrically Isolated Tab)

N-Channel Enhancement Mode

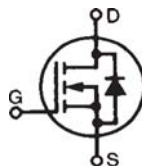

ISOPLUS i4-Pak™

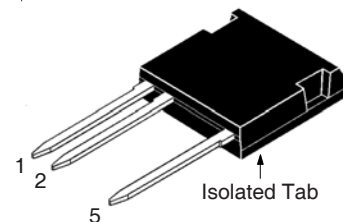

1 = Gate 5 = Drain
2 = Source

| Symbol | Test Conditions | Maximum Ratings | |
|---------------|---|-------------------|------------------|
| V_{DSS} | $T_J = 25^\circ\text{C}$ to 150°C | 2000 | V |
| V_{DGR} | $T_J = 25^\circ\text{C}$ to 150°C , $R_{GS} = 1M\Omega$ | 2000 | V |
| V_{GSS} | Continuous | ± 20 | V |
| V_{GSM} | Transient | ± 30 | V |
| I_{D25} | $T_C = 25^\circ\text{C}$ | 4.0 | A |
| I_{D110} | $T_C = 110^\circ\text{C}$ | 2.3 | A |
| I_{DM} | $T_C = 25^\circ\text{C}$, Pulse Width Limited by T_{JM} | 18.0 | A |
| P_D | $T_C = 25^\circ\text{C}$ | 215 | W |
| T_J | | - 55 ... +150 | $^\circ\text{C}$ |
| T_{JM} | | 150 | $^\circ\text{C}$ |
| T_{stg} | | - 55 ... +150 | $^\circ\text{C}$ |
| T_L | Maximum Lead Temperature for Soldering | 300 | $^\circ\text{C}$ |
| T_{SOLD} | 1.6 mm (0.062in.) from Case for 10s | 260 | $^\circ\text{C}$ |
| F_C | Mounting Force | 20..120 / 4.5..27 | N/lb |
| V_{ISOL} | 50/60Hz, 1 Minute | 2500 | V~ |
| Weight | | 6 | g |

Features

- Silicon Chip on Direct-Copper Bond (DCB) Substrate
- Isolated Mounting Surface
- 2500V~ Electrical Isolation
- High Blocking Voltage
- High Voltage Package

Advantages

- Easy to Mount
- Space Savings
- High Power Density

Applications

- High Voltage Power Supplies
- Capacitor Discharge Applications
- Pulse Circuits
- Laser and X-Ray Generation Systems

| Symbol | Test Conditions ($T_J = 25^\circ\text{C}$, Unless Otherwise Specified) | Characteristic Values | | |
|--------------|---|-----------------------|------|-----------------------|
| | | Min. | Typ. | Max. |
| BV_{DSS} | $V_{GS} = 0V$, $I_D = 250\mu A$ | 2000 | | V |
| $V_{GS(th)}$ | $V_{DS} = V_{GS}$, $I_D = 250\mu A$ | 3.0 | | 5.0 V |
| I_{GSS} | $V_{GS} = \pm 20V$, $V_{DS} = 0V$ | | | ± 100 nA |
| I_{DSS} | $V_{DS} = 0.8 \cdot V_{DSS}$, $V_{GS} = 0V$ Note 2, $T_J = 100^\circ\text{C}$ | | 150 | 25 μA μA |
| $R_{DS(on)}$ | $V_{GS} = 10V$, $I_D = 3A$, Note 1 | | | 4.2 Ω |

| Symbol | Test Conditions ($T_J = 25^\circ\text{C}$, Unless Otherwise Specified) | Characteristic Values | | |
|--------------|--|-----------------------|------|-------------------------|
| | | Min. | Typ. | Max. |
| g_{fs} | $V_{DS} = 30\text{V}, I_D = 3\text{A}$, Note 1 | 4.5 | 7.5 | S |
| C_{iss} | $V_{GS} = 0\text{V}, V_{DS} = 25\text{V}, f = 1\text{MHz}$ | | 3700 | pF |
| C_{oss} | | | 236 | pF |
| C_{rss} | | | 104 | pF |
| R_{Gi} | Gate Input Resistance | | 2.5 | Ω |
| $t_{d(on)}$ | Resistive Switching Times $V_{GS} = 10\text{V}, V_{DS} = 500\text{V}, I_D = 3\text{A}$ $R_G = 2\Omega$ (External) | | 28 | ns |
| t_r | | | 22 | ns |
| $t_{d(off)}$ | | | 80 | ns |
| t_f | | | 46 | ns |
| $Q_{g(on)}$ | $V_{GS} = 10\text{V}, V_{DS} = 0.5 \cdot V_{DSS}, I_D = 3\text{A}$ | | 143 | nC |
| Q_{gs} | | | 21 | nC |
| Q_{gd} | | | 70 | nC |
| R_{thJC} | | | | 0.58 $^\circ\text{C/W}$ |
| R_{thCS} | | 0.15 | | $^\circ\text{C/W}$ |

Source-Drain Diode

| Symbol | Test Conditions ($T_J = 25^\circ\text{C}$, Unless Otherwise Specified) | Characteristic Values | | |
|----------|--|-----------------------|------|-------|
| | | Min. | Typ. | Max. |
| I_S | $V_{GS} = 0\text{V}$ | | | 6 A |
| I_{SM} | Repetitive, Pulse Width Limited by T_{JM} | | | 24 A |
| V_{SD} | $I_F = I_S, V_{GS} = 0\text{V}$, Note 1 | | | 1.5 V |
| t_{rr} | $I_F = 3\text{A}, -di/dt = 100\text{A}/\mu\text{s}$ $V_R = 100\text{V}, V_{GS} = 0\text{V}$ | | 520 | ns |
| Q_{RM} | | | 580 | nC |
| I_{RM} | | | 2.2 | A |

Notes:

1. Pulse test, $t \leq 300\mu\text{s}$, duty cycle, $d \leq 2\%$.
2. Device must be heatsunk for high-temperature leakage current measurements to avoid thermal runaway.

ADVANCE TECHNICAL INFORMATION

The product presented herein is under development. The Technical Specifications offered are derived from a subjective evaluation of the design, based upon prior knowledge and experience, and constitute a "considered reflection" of the anticipated result. IXYS reserves the right to change limits, test conditions, and dimensions without notice.

IXYS Reserves the Right to Change Limits, Test Conditions, and Dimensions.

IXYS MOSFETs and IGBTs are covered by one or more of the following U.S. patents:

| | | | | | | | | | |
|-----------|-----------|-----------|-----------|--------------|--------------|--------------|--------------|--------------|-------------|
| 4,835,592 | 4,931,844 | 5,049,961 | 5,237,481 | 6,162,665 | 6,404,065 B1 | 6,683,344 | 6,727,585 | 7,005,734 B2 | 7,157,338B2 |
| 4,860,072 | 5,017,508 | 5,063,307 | 5,381,025 | 6,259,123 B1 | 6,534,343 | 6,710,405 B2 | 6,759,692 | 7,063,975 B2 | |
| 4,881,106 | 5,034,796 | 5,187,117 | 5,486,715 | 6,306,728 B1 | 6,583,505 | 6,710,463 | 6,771,478 B2 | 7,071,537 | |

Fig. 1. Output Characteristics @ $T_J = 25^\circ\text{C}$

Fig. 2. Output Characteristics @ $T_J = 125^\circ\text{C}$

Fig. 3. $R_{DS(on)}$ Normalized to $I_D = 3\text{A}$ Value vs. Junction Temperature

Fig. 4. $R_{DS(on)}$ Normalized to $I_D = 3\text{A}$ Value vs. Drain Current

Fig. 5. Maximum Drain Current vs. Case Temperature

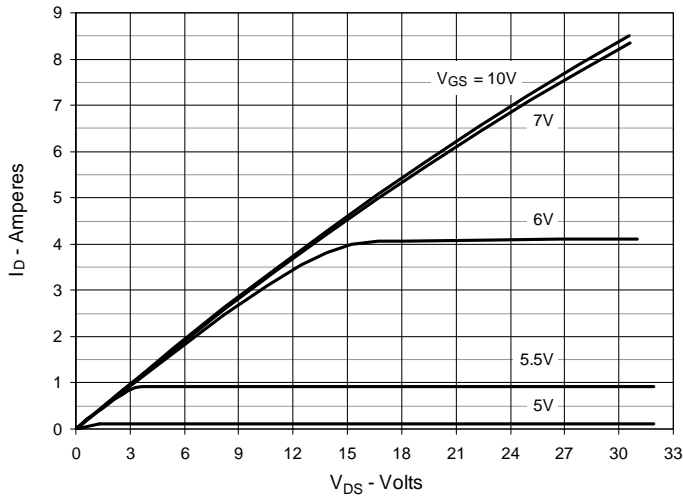
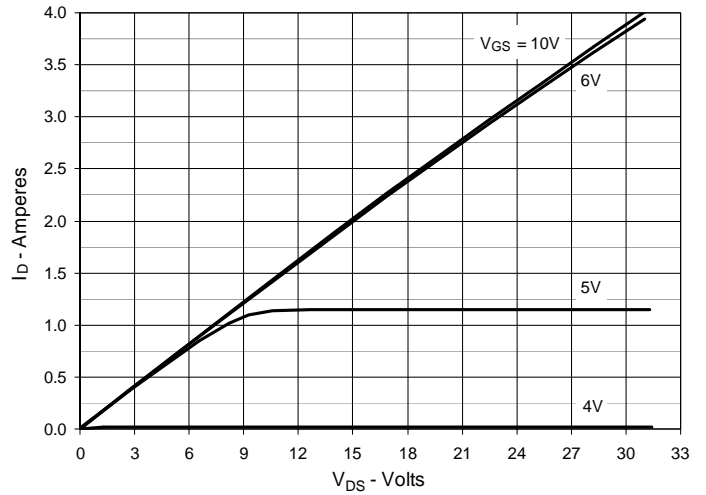
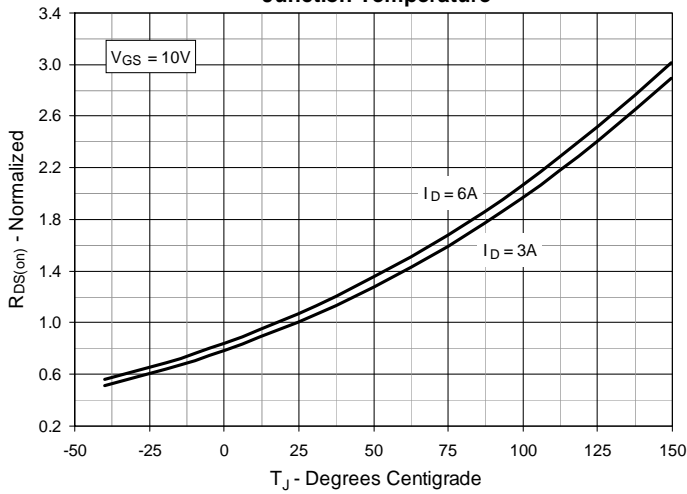
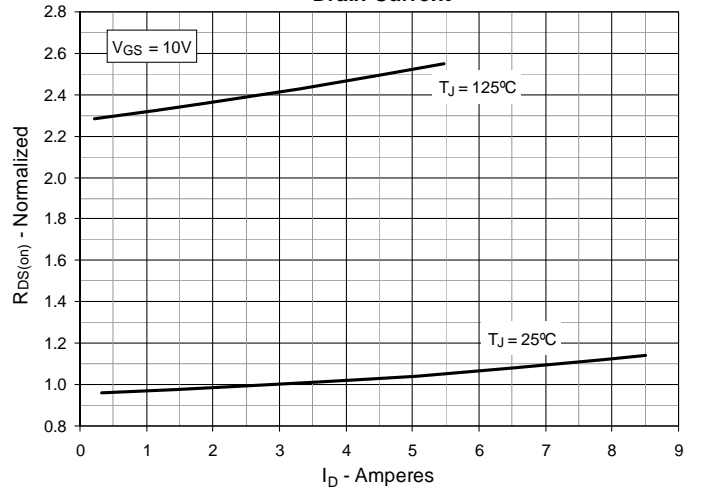
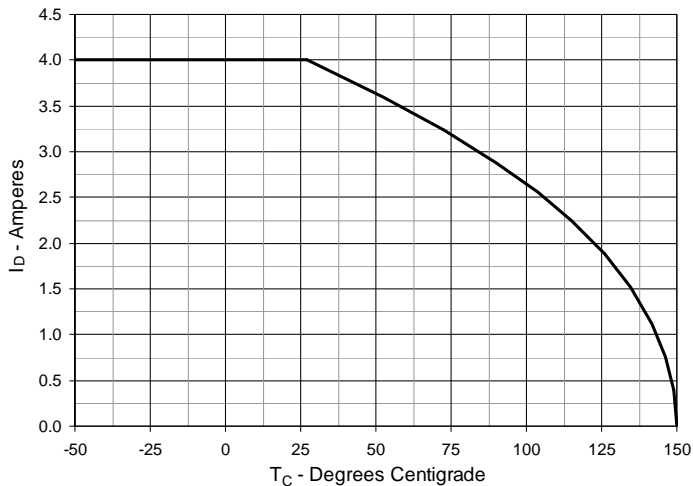
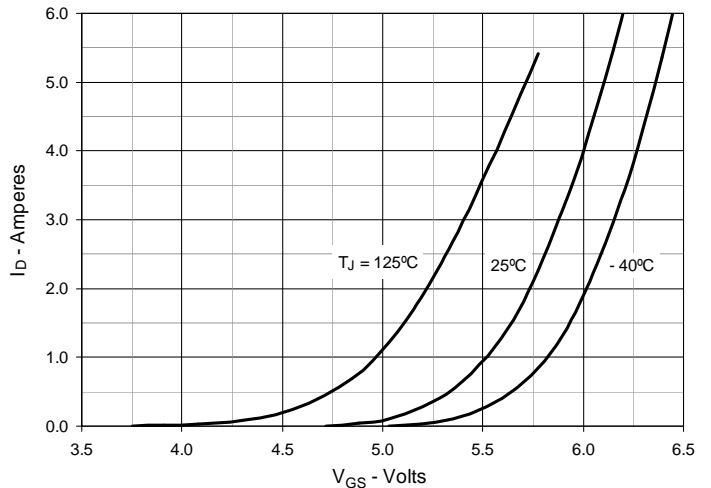
Fig. 6. Input Admittance

Fig. 7. Transconductance

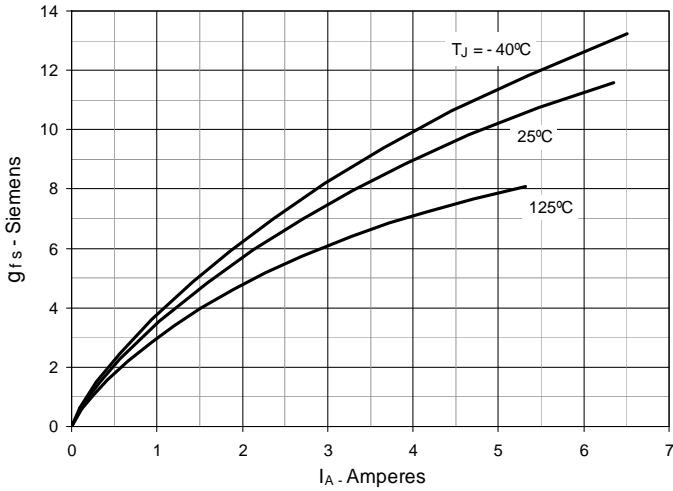

Fig. 8. Forward Voltage Drop of Intrinsic Diode

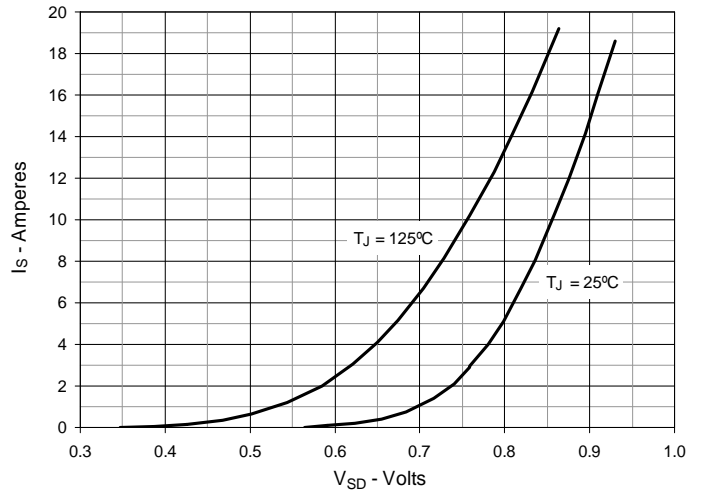

Fig. 9. Gate Charge

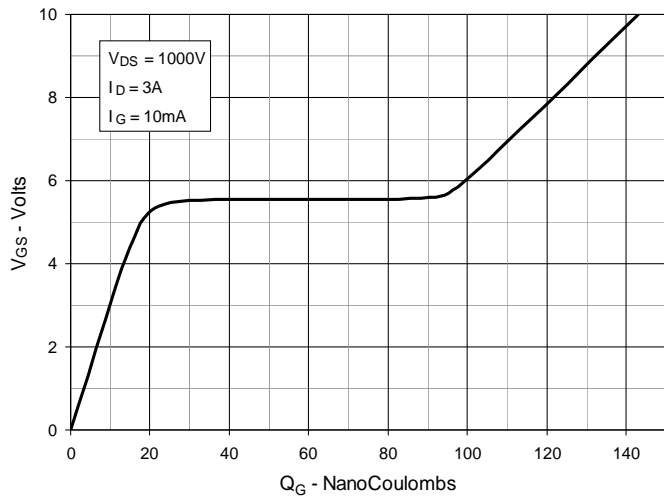

Fig. 10. Capacitance

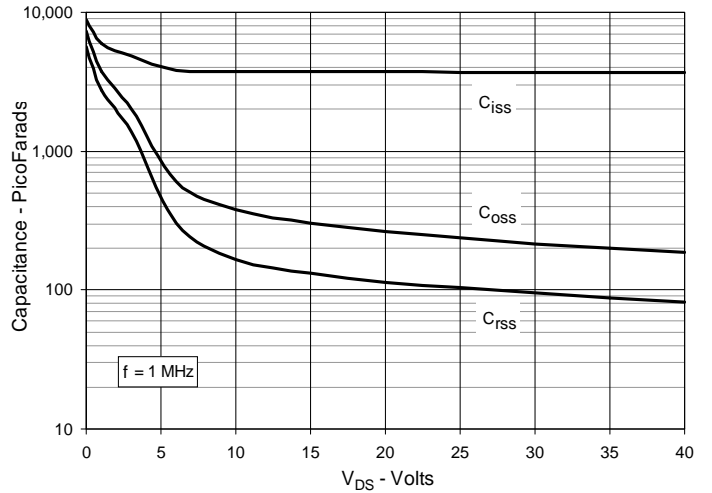

Fig. 11. Forward-Bias Safe Operating Area

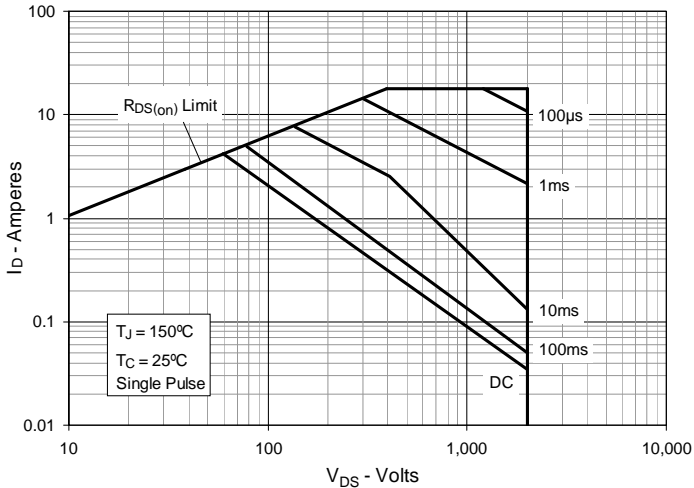
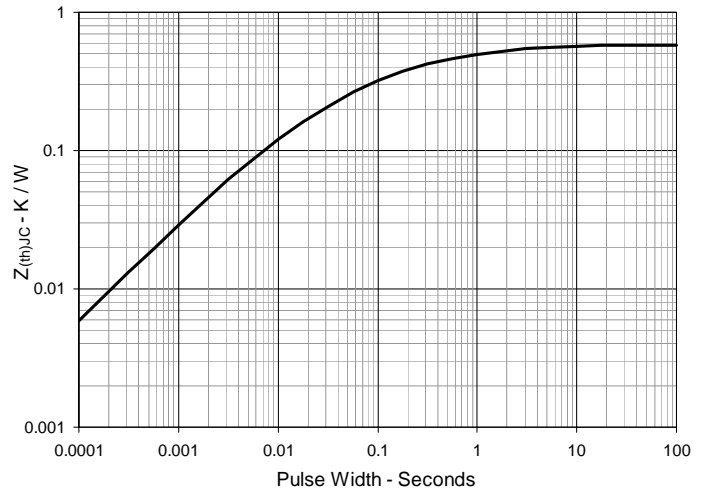
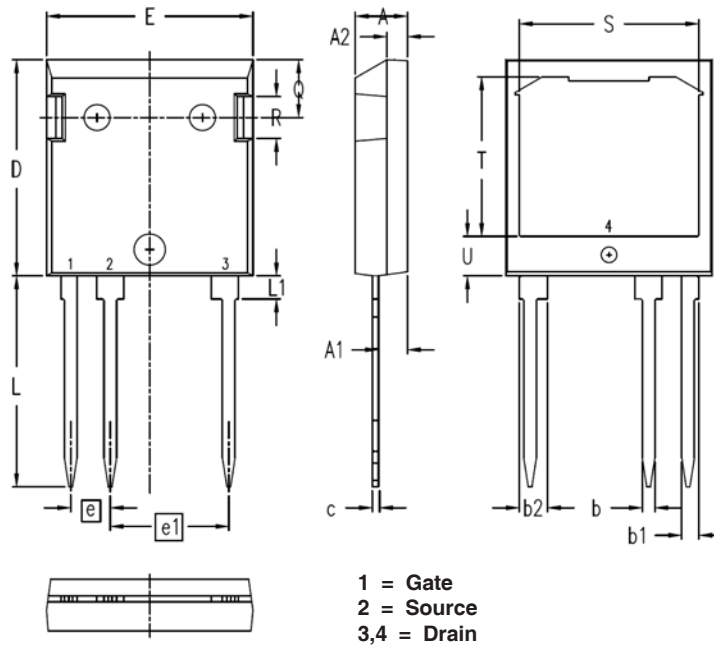

Fig. 12. Maximum Transient Thermal Impedance



ISOPLUS i4-Pak Outline

| SYM | INCHES | | MILLIMETERS | |
|-----|----------|------|-------------|-------|
| | MIN | MAX | MIN | MAX |
| A | .193 | .201 | 4.90 | 5.10 |
| A1 | .106 | .114 | 2.70 | 2.90 |
| A2 | .075 | .083 | 1.90 | 2.10 |
| b | .047 | .055 | 1.20 | 1.40 |
| b1 | .061 | .069 | 1.55 | 1.75 |
| b2 | .087 | .094 | 2.20 | 2.40 |
| c | .020 | .029 | 0.51 | 0.74 |
| D | .819 | .846 | 20.80 | 21.50 |
| E | .768 | .799 | 19.50 | 20.30 |
| e | .150 BSC | | 3.81 BSC | |
| e1 | .450 BSC | | 11.43 BSC | |
| L | .780 | .838 | 19.80 | 21.30 |
| L1 | .083 | .094 | 2.10 | 2.40 |
| Q | .213 | .236 | 5.40 | 6.00 |
| R | .157 | .169 | 4.00 | 4.30 |
| S | .673 | .685 | 17.10 | 17.40 |
| T | .602 | .614 | 15.30 | 15.60 |
| U | .142 | .154 | 3.60 | 3.90 |



Disclaimer Notice - Information furnished is believed to be accurate and reliable. However, users should independently evaluate the suitability of and test each product selected for their own applications. Littelfuse products are not designed for, and may not be used in, all applications. Read complete Disclaimer Notice at www.littelfuse.com/disclaimer-electronics.