

High Voltage Power MOSFET

IXTF1N450

$$V_{DSS} = 4500V$$

$$I_{D25} = 0.9A$$

$$R_{DS(on)} \leq 80\Omega$$

(Electrically Isolated Tab)

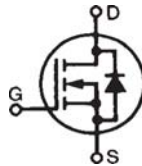

N-Channel Enhancement Mode

ISOPLUS i4-Pak™

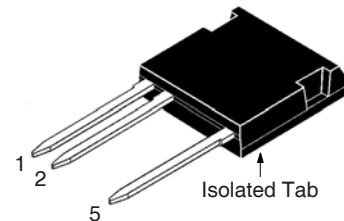

1 = Gate 5 = Drain
2 = Source

Symbol	Test Conditions	Maximum Ratings	
V_{DSS}	$T_J = 25^\circ C$ to $150^\circ C$	4500	V
V_{DGR}	$T_J = 25^\circ C$ to $150^\circ C$, $R_{GS} = 1M\Omega$	4500	V
V_{GSS}	Continuous	± 20	V
V_{GSM}	Transient	± 30	V
I_{D25}	$T_C = 25^\circ C$	0.9	A
I_{DM}	$T_C = 25^\circ C$, Pulse Width Limited by T_{JM}	3.0	A
P_D	$T_C = 25^\circ C$	160	W
T_J		- 55 ... +150	$^\circ C$
T_{JM}		150	$^\circ C$
T_{stg}		- 55 ... +150	$^\circ C$
T_L	Maximum Lead Temperature for Soldering	300	$^\circ C$
T_{SOLD}	Plastic Body for 10s	260	$^\circ C$
F_C	Mounting Force	20..120 / 4.5..27	N/lb.
V_{ISOL}	50/60Hz, 1 Minute	4500	V~
Weight		6	g

Features

- Silicon Chip on Direct-Copper Bond (DCB) Substrate
- Isolated Mounting Surface
- 4500V~ Electrical Isolation
- Molding Epoxies meet UL 94 V-0 Flammability Classification

Advantages

- High Voltage Package
- Easy to Mount
- Space Savings
- High Power Density

Applications

- High Voltage Power Supplies
- Capacitor Discharge Applications
- Pulse Circuits
- Laser and X-Ray Generation Systems

Symbol	Test Conditions ($T_J = 25^\circ C$, Unless Otherwise Specified)	Characteristic Values		
		Min.	Typ.	Max.
$V_{GS(th)}$	$V_{DS} = V_{GS}$, $I_D = 250\mu A$	3.5		6.0 V
I_{GSS}	$V_{GS} = \pm 20V$, $V_{DS} = 0V$			± 100 nA
I_{DSS}	$V_{DS} = 3.6kV$, $V_{GS} = 0V$			5 μA
	$V_{DS} = 4.5kV$			25 μA
	$V_{DS} = 3.6kV$ Note 2, $T_J = 100^\circ C$		15	μA
$R_{DS(on)}$	$V_{GS} = 10V$, $I_D = 50mA$, Note 1			80 Ω

Symbol	Test Conditions ($T_J = 25^\circ\text{C}$, Unless Otherwise Specified)	Characteristic Values		
		Min.	Typ.	Max.
g_{fs}	$V_{DS} = 50\text{V}$, $I_D = 200\text{mA}$, Note 1	0.40	0.70	S
C_{iss}	$V_{GS} = 0\text{V}$, $V_{DS} = 25\text{V}$, $f = 1\text{MHz}$		1700	pF
C_{oss}			80	pF
C_{rss}			29	pF
R_{Gi}	Gate Input Resistance		12	Ω
$t_{d(on)}$	Resistive Switching Times $V_{GS} = 10\text{V}$, $V_{DS} = 500\text{V}$, $I_D = 0.5\text{A}$ $R_G = 10\Omega$ (External)		30	ns
t_r			43	ns
$t_{d(off)}$			73	ns
t_f			120	ns
$Q_{g(on)}$	$V_{GS} = 10\text{V}$, $V_{DS} = 1\text{kV}$, $I_D = 0.5\text{A}$		46	nC
Q_{gs}			8	nC
Q_{gd}			23	nC
R_{thJC}			0.77	$^\circ\text{C/W}$
R_{thCS}		0.15		$^\circ\text{C/W}$

Source-Drain Diode

Symbol	Test Conditions ($T_J = 25^\circ\text{C}$, Unless Otherwise Specified)	Characteristic Values		
		Min.	Typ.	Max.
I_S	$V_{GS} = 0\text{V}$			1 A
I_{SM}	Repetitive, Pulse Width Limited by T_{JM}			5 A
V_{SD}	$I_F = 1\text{A}$, $V_{GS} = 0\text{V}$, Note 1			2.0 V
t_{rr}	$I_F = 1\text{A}$, $-di/dt = 50\text{A}/\mu\text{s}$, $V_R = 100\text{V}$		1.75	μs

- Notes: 1. Pulse test, $t \leq 300\mu\text{s}$, duty cycle, $d \leq 2\%$.
2. Part must be heatsunk for high-temp I_{DSS} measurement.

ISOPLUS i4-Pak™ (HV) Outline

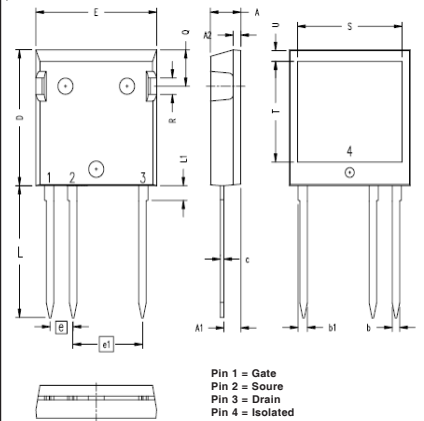

SYM	INCHES		MILLIMETERS	
	MIN	MAX	MIN	MAX
A	.190	.205	4.83	5.21
A1	.102	.118	2.59	3.00
A2	.046	.085	1.17	2.16
b	.045	.055	1.14	1.40
b1	.058	.068	1.47	1.73
C	.020	.029	0.51	0.74
D	.819	.840	20.80	21.34
E	.770	.799	19.56	20.29
e	.150 BSC		3.81 BSC	
e1	.450 BSC		11.43 BSC	
L	.780	.840	19.81	21.34
L1	.083	.102	2.11	2.59
Q	.210	.244	5.33	6.20
R	.100	.180	2.54	4.57
S	.660	.690	16.76	17.53
T	.590	.620	14.99	15.75
U	.065	.080	1.65	2.03

IXYS Reserves the Right to Change Limits, Test Conditions, and Dimensions.

IXYS MOSFETs and IGBTs are covered by one or more of the following U.S. patents:	4,835,592	4,931,844	5,049,961	5,237,481	6,162,665	6,404,065 B1	6,683,344	6,727,585	7,005,734 B2	7,157,338 B2
	4,860,072	5,017,508	5,063,307	5,381,025	6,259,123 B1	6,534,343	6,710,405 B2	6,759,692	7,063,975 B2	
	4,881,106	5,034,796	5,187,117	5,486,715	6,306,728 B1	6,583,505	6,710,463	6,771,478 B2	7,071,537	

Fig. 1. Output Characteristics @ $T_J = 25^\circ\text{C}$

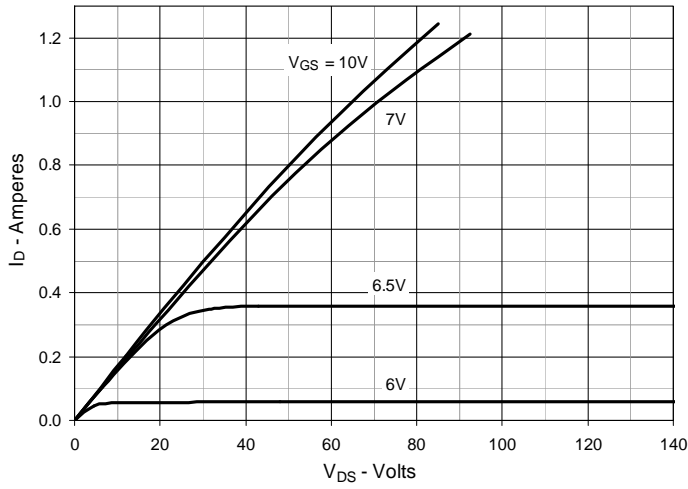

Fig. 2. Output Characteristics @ $T_J = 125^\circ\text{C}$

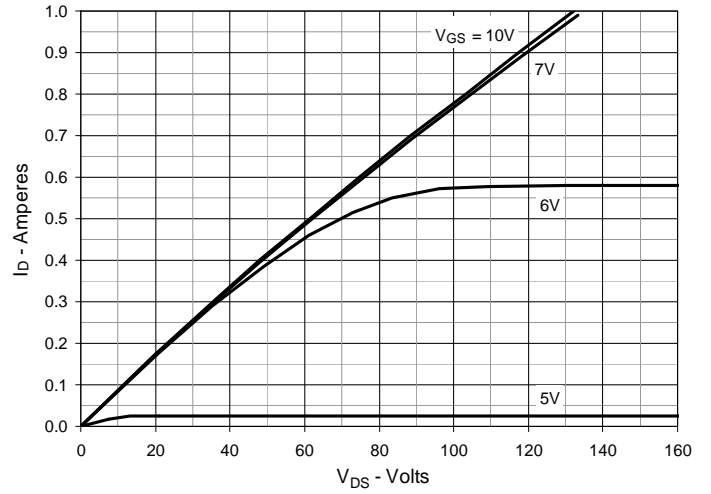

Fig. 3. $R_{DS(on)}$ Normalized to $I_D = 0.5\text{A}$ Value vs. Junction Temperature

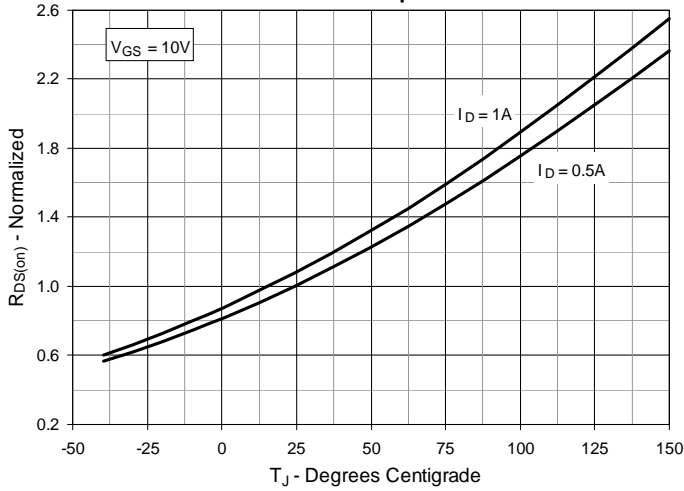

Fig. 4. $R_{DS(on)}$ Normalized to $I_D = 0.5\text{A}$ Value vs. Drain Current

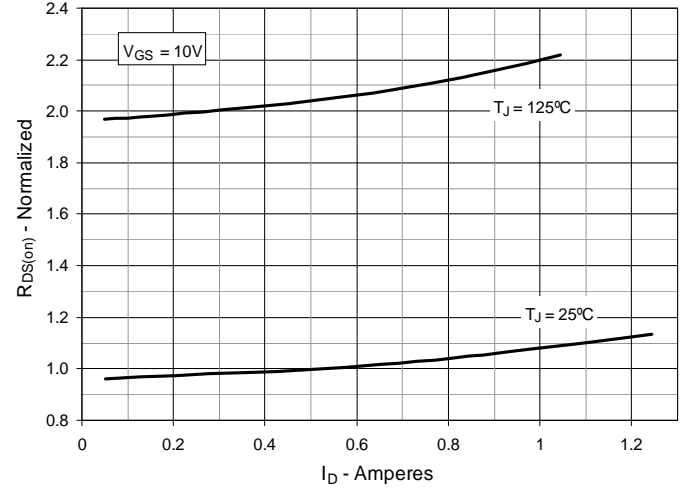

Fig. 5. Maximum Drain Current vs. Case Temperature

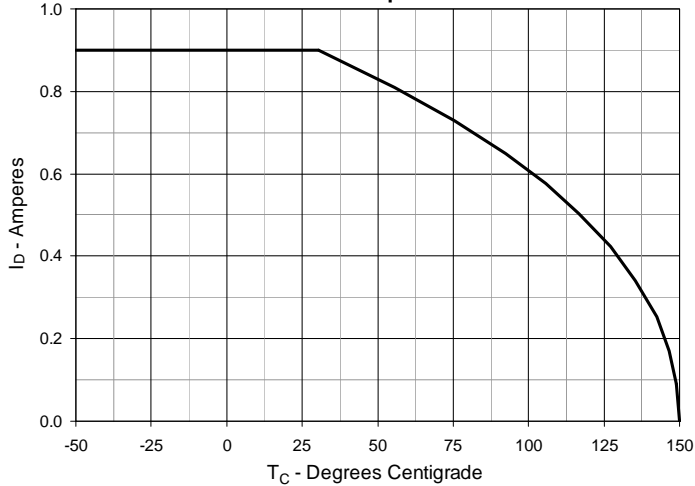

Fig. 6. Input Admittance

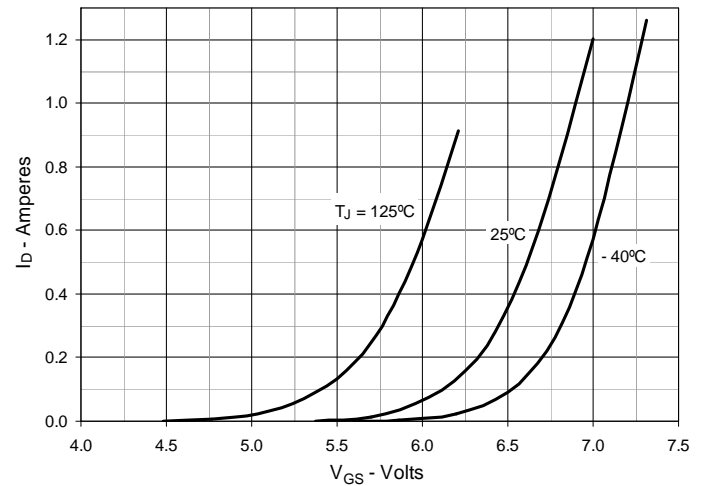

Fig. 7. Transconductance

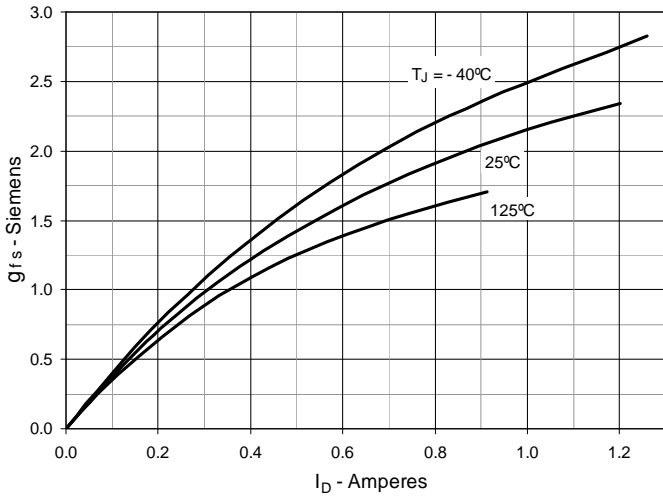

Fig. 8. Forward Voltage Drop of Intrinsic Diode

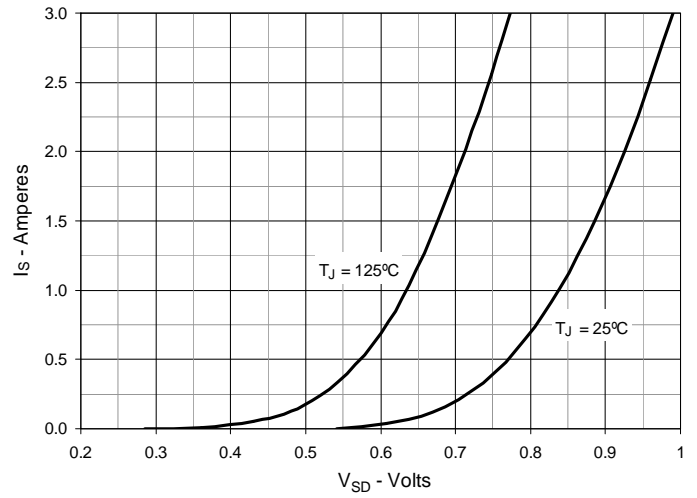

Fig. 9. Gate Charge

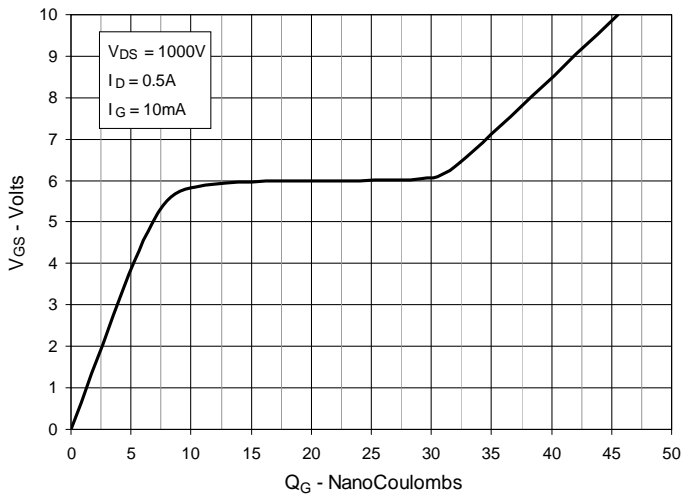

Fig. 10. Capacitance

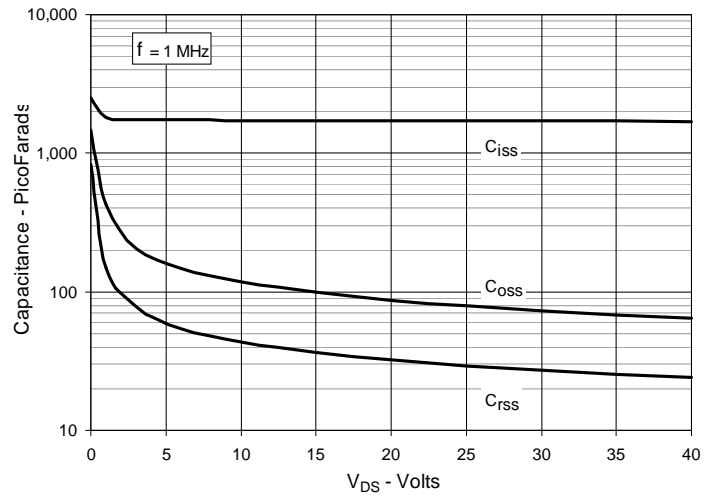

Fig. 11. Maximum Transient Thermal Impedance

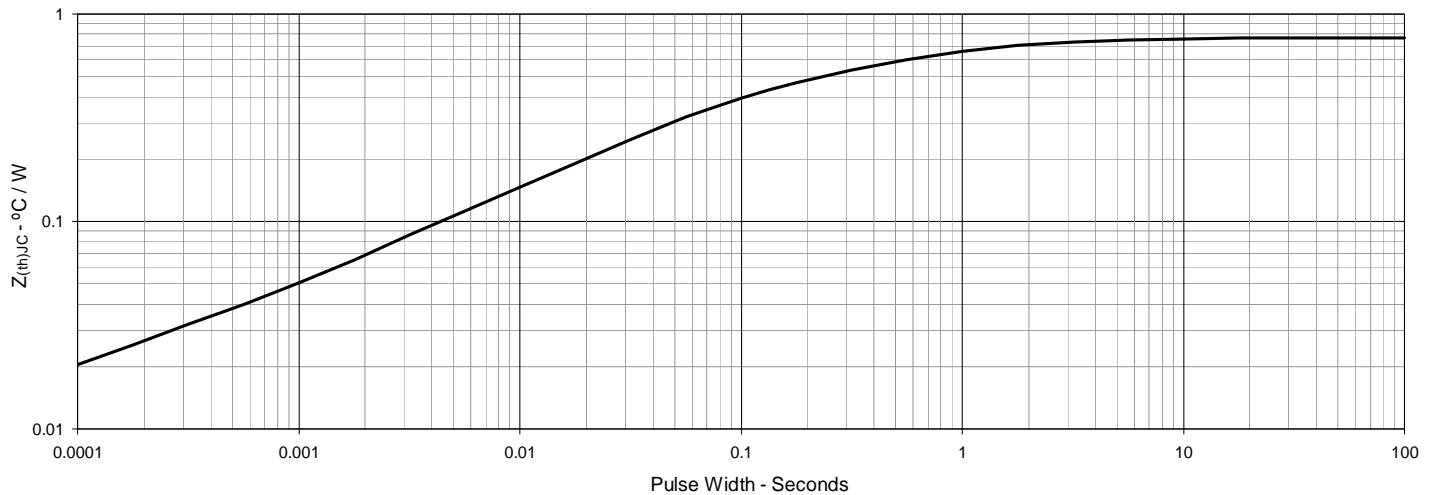

Fig. 12. Forward-Bias Safe Operating Area
@ $T_C = 25^\circ\text{C}$

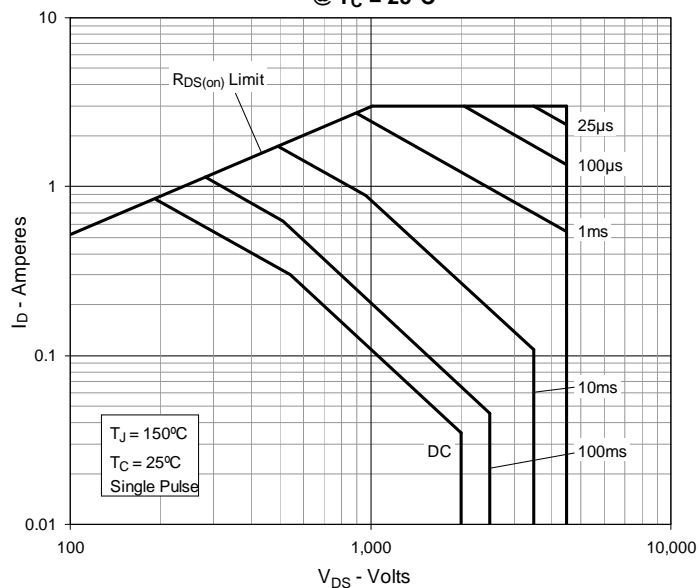
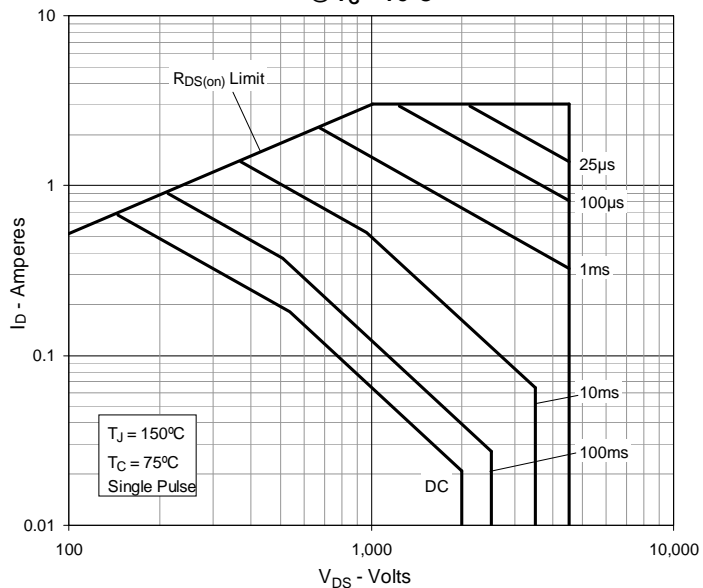

Fig. 13. Forward-Bias Safe Operating Area
@ $T_C = 75^\circ\text{C}$





Disclaimer Notice - Information furnished is believed to be accurate and reliable. However, users should independently evaluate the suitability of and test each product selected for their own applications. Littelfuse products are not designed for, and may not be used in, all applications. Read complete Disclaimer Notice at www.littelfuse.com/disclaimer-electronics.