

High Voltage Power MOSFET

IXTF1N400

$$V_{DSS} = 4000V$$

$$I_{D25} = 1A$$

$$R_{DS(on)} \leq 60\Omega$$

(Electrically Isolated Tab)

N-Channel Enhancement Mode

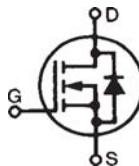

| Symbol | Test Conditions | Maximum Ratings | |
|---------------|---|-------------------|------------|
| V_{DSS} | $T_J = 25^\circ C$ to $150^\circ C$ | 4000 | V |
| V_{DGR} | $T_J = 25^\circ C$ to $150^\circ C$, $R_{GS} = 1M\Omega$ | 4000 | V |
| V_{GSS} | Continuous | ± 20 | V |
| V_{GSM} | Transient | ± 30 | V |
| I_{D25} | $T_C = 25^\circ C$ | 1 | A |
| I_{DM} | $T_C = 25^\circ C$, Pulse Width Limited by T_{JM} | 3 | A |
| P_D | $T_C = 25^\circ C$ | 160 | W |
| T_J | | - 55 ... +150 | $^\circ C$ |
| T_{JM} | | 150 | $^\circ C$ |
| T_{stg} | | - 55 ... +150 | $^\circ C$ |
| T_L | 1.6mm (0.062 in.) from Case for 10s | 300 | $^\circ C$ |
| T_{SOLD} | Plastic Body for 10s | 260 | $^\circ C$ |
| F_C | Mounting Force | 20..120 / 4.5..27 | N/lb. |
| V_{ISOL} | 50/60Hz, 1 Minute | 4000 | V~ |
| Weight | | 5 | g |

ISOPLUS i4-Pak™

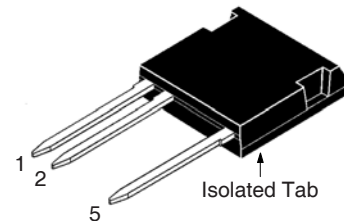

1 = Gate 5 = Drain
2 = Source

Features

- Silicon Chip on Direct-Copper Bond (DCB) Substrate
- Isolated Mounting Surface
- 4000V~ Electrical Isolation
- Molding Epoxies meet UL 94 V-0 Flammability Classification

Advantages

- Easy to Mount
- Space Savings
- High Power Density

Applications

- High Voltage Power Supplies
- Capacitor Discharge Applications
- Pulse Circuits
- Laser and X-Ray Generation Systems

| Symbol | Test Conditions ($T_J = 25^\circ C$, Unless Otherwise Specified) | Characteristic Values | | |
|--------------|--|-----------------------|------|--------------|
| | | Min. | Typ. | Max. |
| $V_{GS(th)}$ | $V_{DS} = V_{GS}$, $I_D = 250\mu A$ | 2.0 | | 4.0 V |
| I_{GSS} | $V_{GS} = \pm 20V$, $V_{DS} = 0V$ | | | ± 100 nA |
| I_{DSS} | $V_{DS} = 3.2kV$, $V_{GS} = 0V$ $V_{DS} = 4.0kV$ $V_{DS} = 3.2kV$ Note 2, $T_J = 100^\circ C$ | | | 50 μA |
| | | | | 250 μA |
| | | | 250 | μA |
| $R_{DS(on)}$ | $V_{GS} = 10V$, $I_D = 0.5 \cdot I_{D25}$, Note 1 | | | 60 Ω |

| Symbol | Test Conditions ($T_J = 25^\circ\text{C}$, Unless Otherwise Specified) | Characteristic Values | | |
|--------------|--|-----------------------|------|--------------------|
| | | Min. | Typ. | Max. |
| g_{fs} | $V_{DS} = 50\text{V}$, $I_D = 0.5 \cdot I_{D25}$, Note 1 | 0.55 | 0.95 | S |
| C_{iss} | $V_{GS} = 0\text{V}$, $V_{DS} = 25\text{V}$, $f = 1\text{MHz}$ | | 2530 | pF |
| C_{oss} | | | 93 | pF |
| C_{rss} | | | 30 | pF |
| $t_{d(on)}$ | Resistive Switching Times $V_{GS} = 10\text{V}$, $V_{DS} = 0.5 \cdot V_{DSS}$, $I_D = 1\text{A}$ $R_G = 2\Omega$ (External) | | 28 | ns |
| t_r | | | 24 | ns |
| $t_{d(off)}$ | | | 81 | ns |
| t_f | | | 90 | ns |
| $Q_{g(on)}$ | $V_{GS} = 10\text{V}$, $V_{DS} = 1\text{kV}$, $I_D = 0.5 \cdot I_{D25}$ | | 78 | nC |
| Q_{gs} | | | 10 | nC |
| Q_{gd} | | | 35 | nC |
| R_{thJC} | | | 0.78 | $^\circ\text{C/W}$ |
| R_{thCS} | | 0.15 | | $^\circ\text{C/W}$ |

Source-Drain Diode

| Symbol | Test Conditions ($T_J = 25^\circ\text{C}$, Unless Otherwise Specified) | Characteristic Values | | |
|----------|--|-----------------------|------|---------------|
| | | Min. | Typ. | Max. |
| I_s | $V_{GS} = 0\text{V}$ | | | 1 A |
| I_{SM} | Repetitive, Pulse Width Limited by T_{JM} | | | 5 A |
| V_{SD} | $I_F = 1\text{A}$, $V_{GS} = 0\text{V}$, Note 1 | | | 4 V |
| t_{rr} | $I_F = 1\text{A}$, $-di/dt = 100\text{A}/\mu\text{s}$, $V_R = 200\text{V}$ | | 3.5 | μs |

ISOPLUS i4-Pak™ (HV) Outline

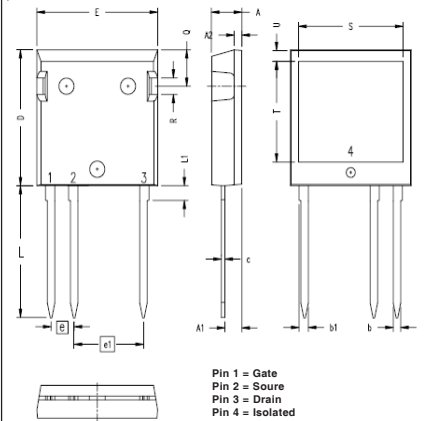

| SYM | INCHES | | MILLIMETERS | |
|-----|----------|------|-------------|-------|
| | MIN | MAX | MIN | MAX |
| A | .190 | .205 | 4.83 | 5.21 |
| A1 | .102 | .118 | 2.59 | 3.00 |
| A2 | .046 | .085 | 1.17 | 2.16 |
| b | .045 | .055 | 1.14 | 1.40 |
| b1 | .058 | .068 | 1.47 | 1.73 |
| C | .020 | .029 | 0.51 | 0.74 |
| D | .819 | .840 | 20.80 | 21.34 |
| E | .770 | .799 | 19.56 | 20.29 |
| e | .150 BSC | | 3.81 BSC | |
| e1 | .450 BSC | | 11.43 BSC | |
| L | .780 | .840 | 19.81 | 21.34 |
| L1 | .083 | .102 | 2.11 | 2.59 |
| Q | .210 | .244 | 5.33 | 6.20 |
| R | .100 | .180 | 2.54 | 4.57 |
| S | .660 | .690 | 16.76 | 17.53 |
| T | .590 | .620 | 14.99 | 15.75 |
| U | .065 | .080 | 1.65 | 2.03 |

- Notes: 1. Pulse test, $t \leq 300\mu\text{s}$, duty cycle, $d \leq 2\%$.
2. Part must be heatsunk for high-temp I_{DSS} measurement.

IXYS Reserves the Right to Change Limits, Test Conditions, and Dimensions.

| | | | | | | | | | | |
|--|-----------|-----------|-----------|-----------|--------------|--------------|--------------|--------------|--------------|-------------|
| IXYS MOSFETs and IGBTs are covered by one or more of the following U.S. patents: | 4,835,592 | 4,931,844 | 5,049,961 | 5,237,481 | 6,162,665 | 6,404,065 B1 | 6,683,344 | 6,727,585 | 7,005,734 B2 | 7,157,338B2 |
| | 4,850,072 | 5,017,508 | 5,063,307 | 5,381,025 | 6,259,123 B1 | 6,534,343 | 6,710,405 B2 | 6,759,692 | 7,063,975 B2 | |
| | 4,881,106 | 5,034,796 | 5,187,117 | 5,486,715 | 6,306,728 B1 | 6,583,505 | 6,710,463 | 6,771,478 B2 | 7,071,537 | |

Fig. 1. Output Characteristics @ $T_J = 25^\circ\text{C}$

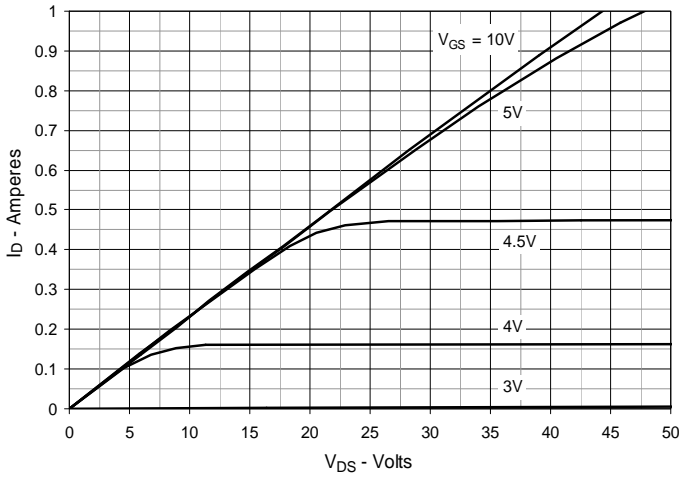

Fig. 2. Extended Output Characteristics @ $T_J = 25^\circ\text{C}$

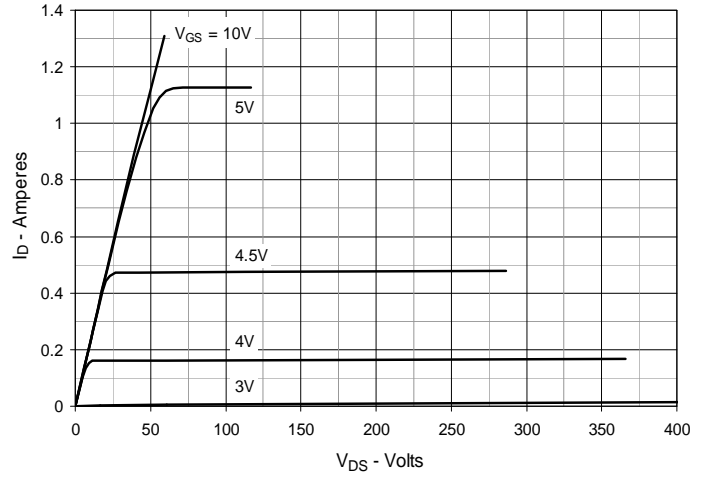

Fig. 3. Output Characteristics @ $T_J = 125^\circ\text{C}$

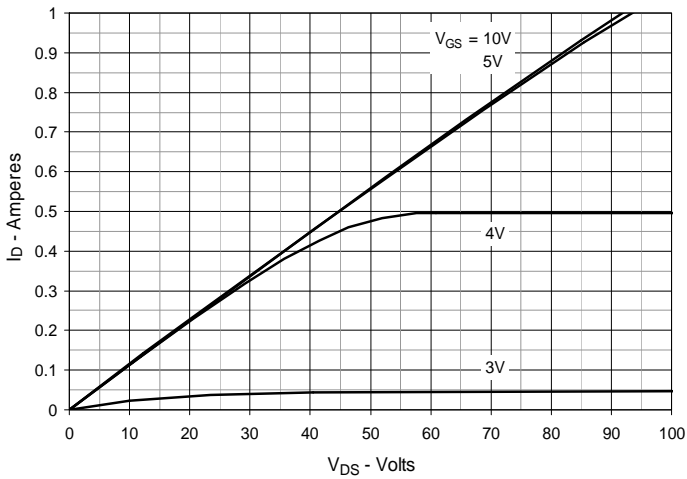

Fig. 4. $R_{DS(on)}$ Normalized to $I_D = 0.5A$ Value vs. Junction Temperature

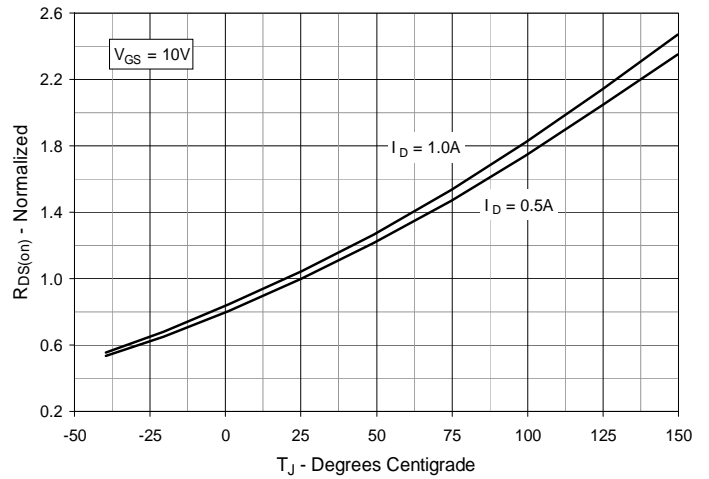

Fig. 5. $R_{DS(on)}$ Normalized to $I_D = 0.5A$ Value vs. Drain Current

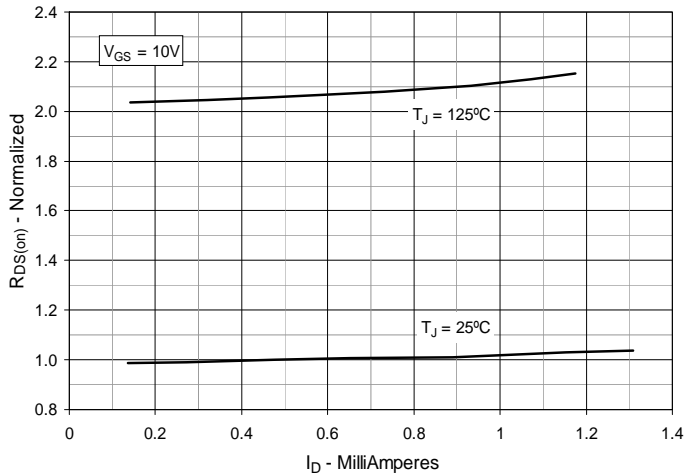

Fig. 6. Maximum Drain Current vs. Case Temperature

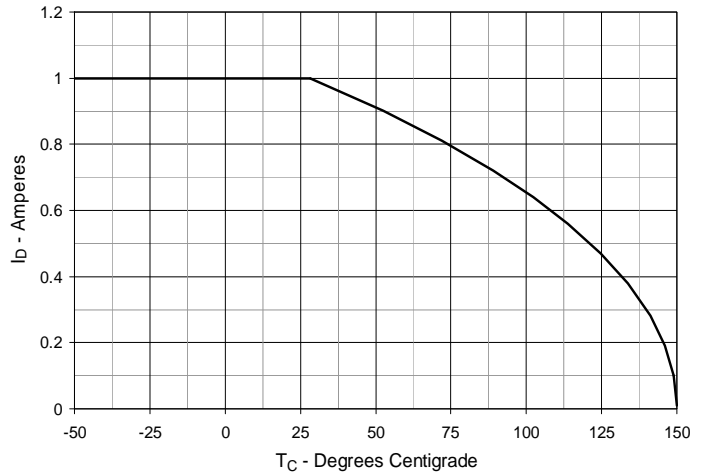

Fig. 7. Input Admittance

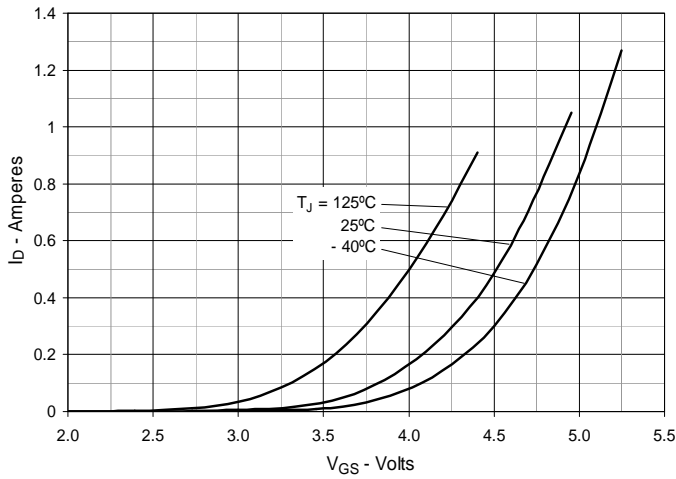

Fig. 8. Transconductance

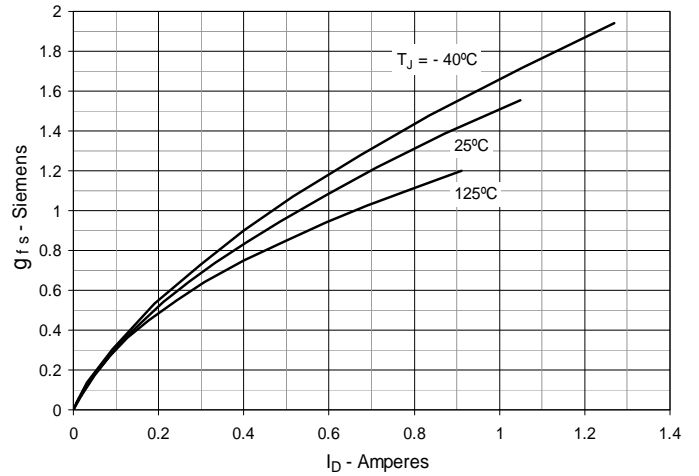

Fig. 9. Forward Voltage Drop of Intrinsic Diode

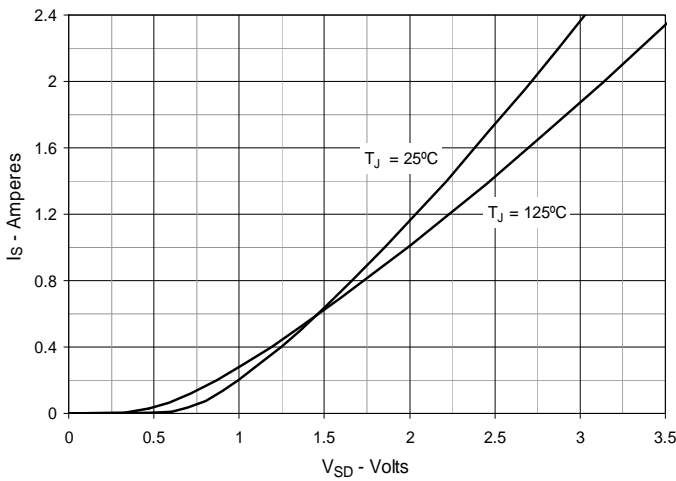

Fig. 10. Gate Charge

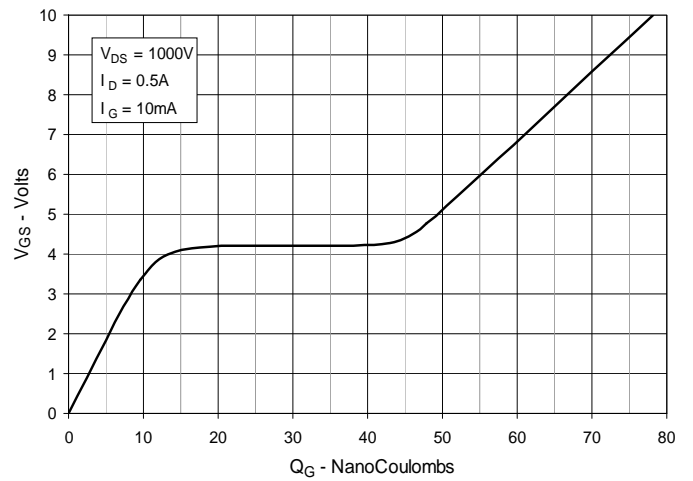

Fig. 11. Capacitance

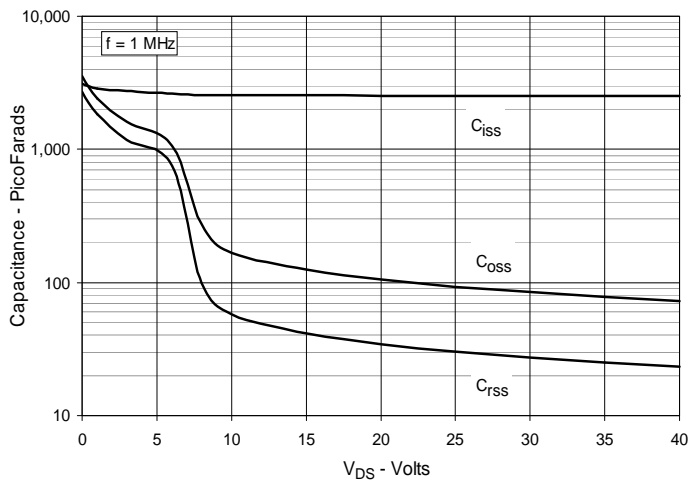
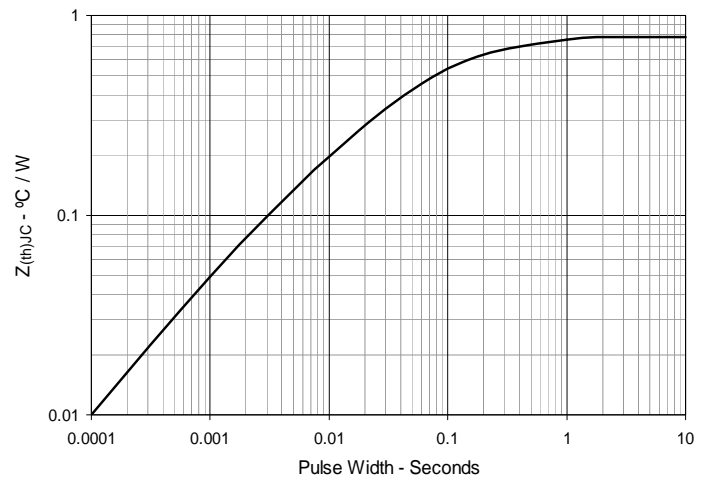

Fig. 12. Maximum Transient Thermal Impedance





Disclaimer Notice - Information furnished is believed to be accurate and reliable. However, users should independently evaluate the suitability of and test each product selected for their own applications. Littelfuse products are not designed for, and may not be used in, all applications. Read complete Disclaimer Notice at www.littelfuse.com/disclaimer-electronics.