

High Voltage Power MOSFETs

IXTA4N150HV IXTT4N150HV

$$V_{DSS} = 1500V$$

$$I_{D25} = 4A$$

$$R_{DS(on)} \leq 6\Omega$$

N-Channel Enhancement Mode
Fast Intrinsic Diode

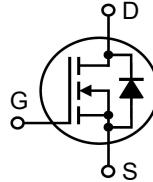

Symbol	Test Conditions	Maximum Ratings	
V_{DSS}	$T_J = 25^\circ C$ to $150^\circ C$	1500	V
V_{DGR}	$T_J = 25^\circ C$ to $150^\circ C$, $R_{GS} = 1M\Omega$	1500	V
V_{GSS}	Continuous	± 30	V
V_{GSM}	Transient	± 40	V
I_{D25}	$T_C = 25^\circ C$	4	A
I_{DM}	$T_C = 25^\circ C$, Pulse Width Limited by T_{JM}	12	A
I_A	$T_C = 25^\circ C$	4	A
E_{AS}	$T_C = 25^\circ C$	350	mJ
dv/dt	$I_S \leq I_{DM}$, $V_{DD} \leq V_{DSS}$, $T_J \leq 150^\circ C$	5	V/ns
P_D	$T_C = 25^\circ C$	280	W
T_J		- 55 ... +150	$^\circ C$
T_{JM}		150	$^\circ C$
T_{stg}		- 55 ... +150	$^\circ C$
T_{SOLD}	Plastic Body for 10s	260	$^\circ C$
Weight	TO-263	2.5	g
	TO-268	4.0	g

TO-263HV

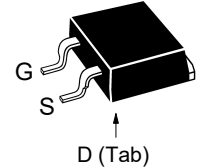

TO-268HV

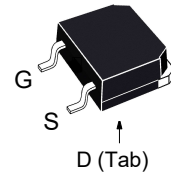

G = Gate D = Drain
S = Source Tab = Drain

Features

- High Blocking Voltage
- High Voltage Package
- Fast Intrinsic Diode
- Low Package Inductance

Advantages

- Easy to Mount
- Space Savings
- High Power Density

Applications

- High Voltage Power Supplies
- Capacitor Discharge
- Pulse Circuits

Symbol	Test Conditions ($T_J = 25^\circ C$, Unless Otherwise Specified)	Characteristic Values		
		Min.	Typ.	Max.
BV_{DSS}	$V_{GS} = 0V$, $I_D = 250\mu A$	1500		V
$V_{GS(th)}$	$V_{DS} = V_{GS}$, $I_D = 250\mu A$	2.5		5.0 V
I_{GSS}	$V_{GS} = \pm 30V$, $V_{DS} = 0V$			± 100 nA
I_{DSS}	$V_{DS} = V_{DSS}$, $V_{GS} = 0V$ $T_J = 125^\circ C$			10 μA 100 μA
$R_{DS(on)}$	$V_{GS} = 10V$, $I_D = 0.5 \cdot I_{D25}$, Note 1			6 Ω

Symbol	Test Conditions ($T_J = 25^\circ\text{C}$, Unless Otherwise Specified)	Characteristic Values		
		Min.	Typ.	Max.
g_{fs}	$V_{DS} = 20\text{V}$, $I_D = 0.5 \cdot I_{D25}$, Note 1	2.8	4.6	S
C_{iss}	$V_{GS} = 0\text{V}$, $V_{DS} = 25\text{V}$, $f = 1\text{MHz}$		1576	pF
C_{oss}			105	pF
C_{rss}			35	pF
$t_{d(on)}$	Resistive Switching Times $V_{GS} = 10\text{V}$, $V_{DS} = 0.5 \cdot V_{DSS}$, $I_D = 0.5 \cdot I_{D25}$ $R_G = 5\Omega$ (External)		19	ns
t_r			23	ns
$t_{d(off)}$			42	ns
t_f			22	ns
$Q_{g(on)}$	$V_{GS} = 10\text{V}$, $V_{DS} = 0.5 \cdot V_{DSS}$, $I_D = 0.5 \cdot I_{D25}$		44.5	nC
Q_{gs}			7.7	nC
Q_{gd}			21.7	nC
R_{thJC}				0.45 $^\circ\text{C/W}$

Source-Drain Diode

Symbol	Test Conditions ($T_J = 25^\circ\text{C}$, Unless Otherwise Specified)	Characteristic Values		
		Min.	Typ.	Max.
I_S	$V_{GS} = 0\text{V}$			4 A
I_{SM}	Repetitive, Pulse Width Limited by T_{JM}			16 A
V_{SD}	$I_F = I_S$, $V_{GS} = 0\text{V}$, Note 1			1.3 V
t_{rr}	$I_F = 2\text{A}$, $-di/dt = 100\text{A}/\mu\text{s}$ $V_R = 100\text{V}$, $V_{GS} = 0\text{V}$		0.9	μs
I_{RM}			15.0	A
Q_{RM}			6.7	μC

Note 1. Pulse test, $t \leq 300\mu\text{s}$, duty cycle, $d \leq 2\%$.

Littelfuse reserves the right to change limits, test conditions, and dimensions.

LF MOSFETs and IGBTs are covered by one or more of the following U.S. patents:	4,835,592	4,931,844	5,049,961	5,237,481	6,162,665	6,404,065 B1	6,683,344	6,727,585	7,005,734 B2	7,157,338 B2
	4,860,072	5,017,508	5,063,307	5,381,025	6,259,123 B1	6,534,343	6,710,405 B2	6,759,692	7,063,975 B2	
	4,881,106	5,034,796	5,187,117	5,486,715	6,306,728 B1	6,583,505	6,710,463	6,771,478 B2	7,071,537	

Fig. 1. Output Characteristics @ $T_J = 25^\circ\text{C}$

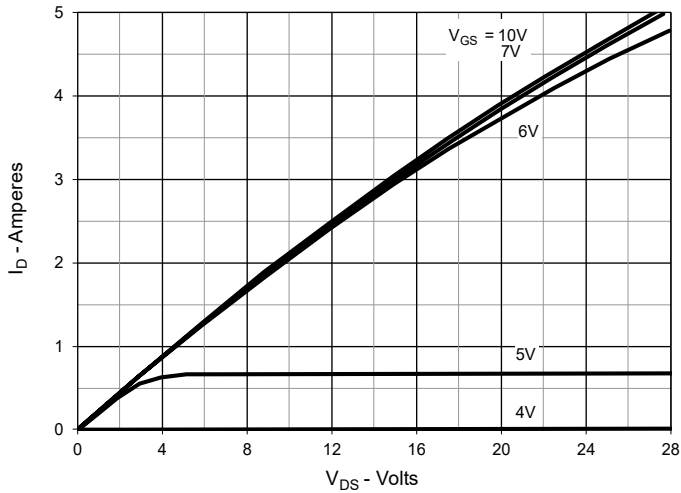

Fig. 2. Output Characteristics @ $T_J = 125^\circ\text{C}$

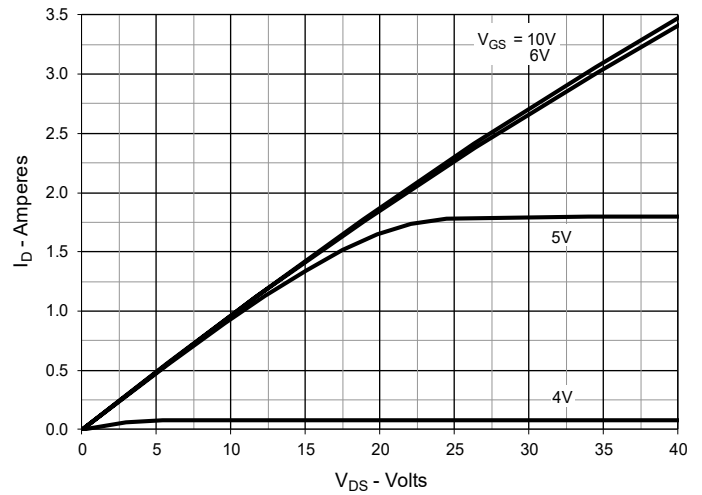

Fig. 3. $R_{DS(on)}$ Normalized to $I_D = 2\text{A}$ Value vs. Junction Temperature

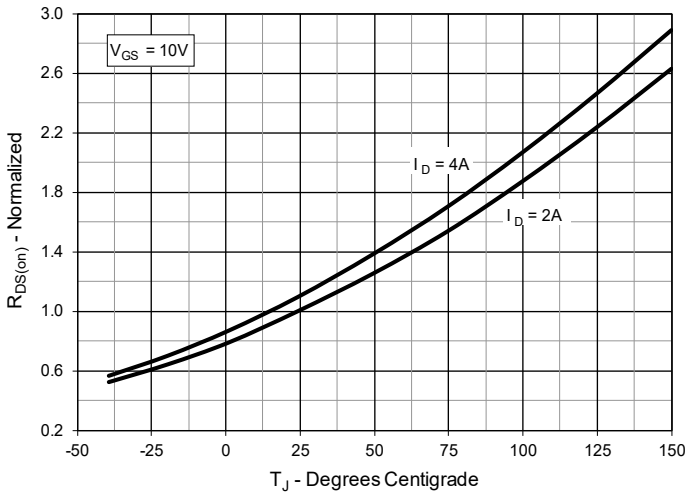

Fig. 4. $R_{DS(on)}$ Normalized to $I_D = 2\text{A}$ Value vs. Drain Current

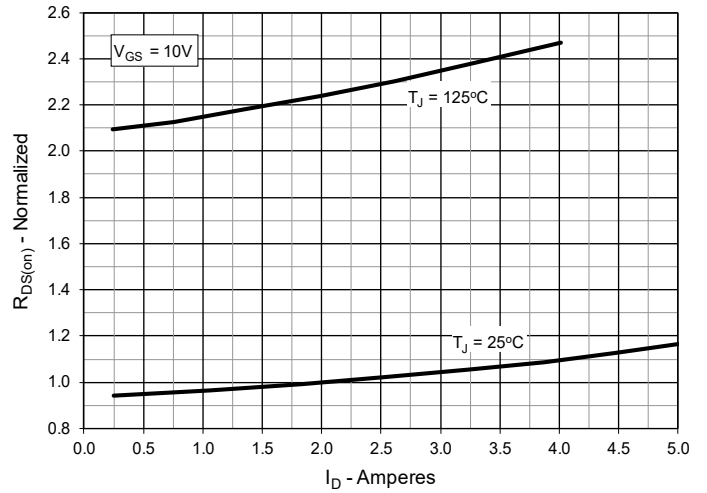

Fig. 5. Maximum Drain Current vs. Case Temperature

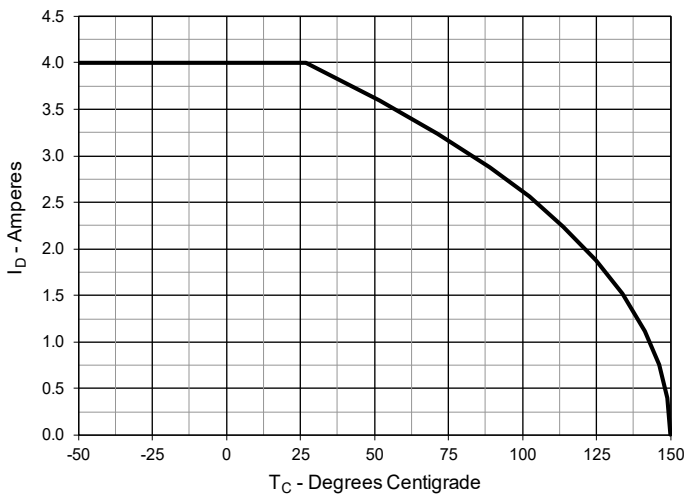

Fig. 6. Input Admittance

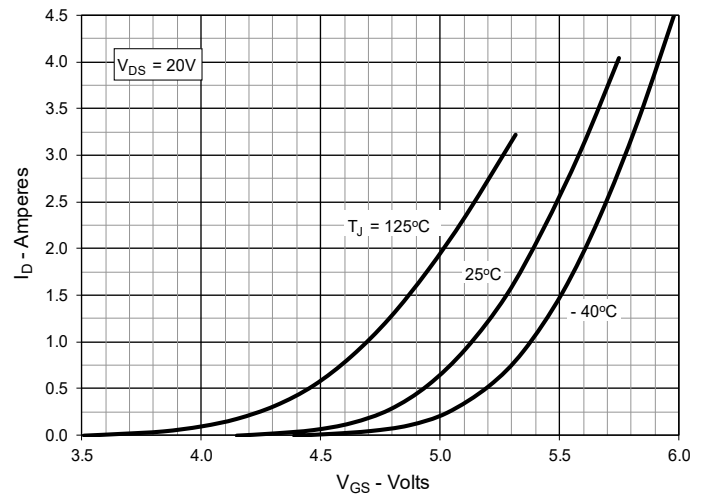

Fig. 7. Transconductance

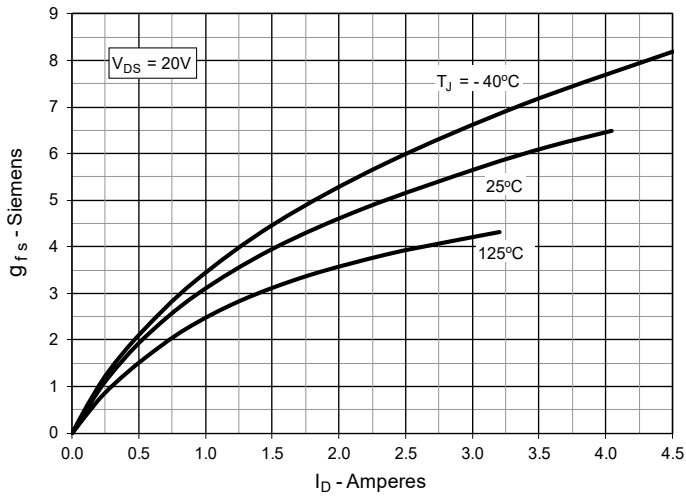

Fig. 8. Forward Voltage Drop of Intrinsic Diode

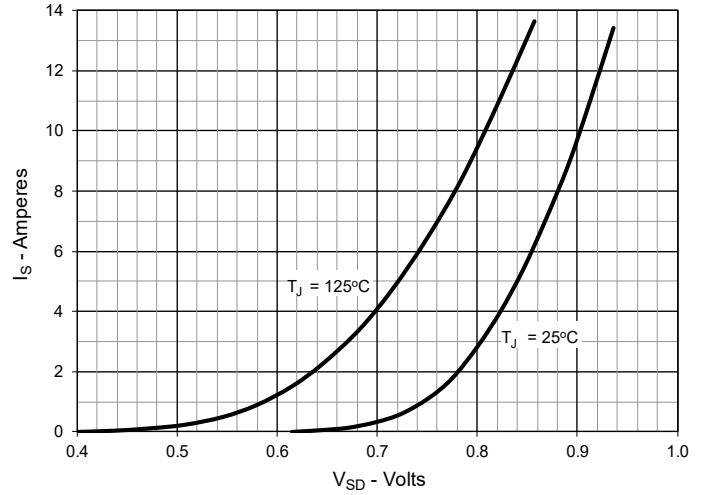

Fig. 9. Gate Charge

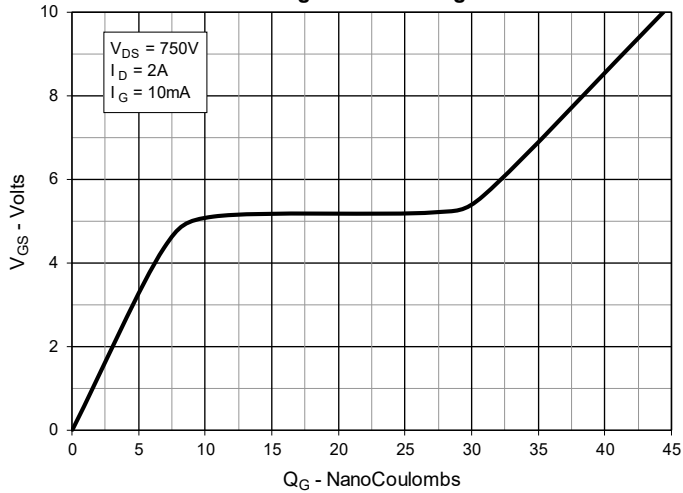

Fig. 10. Capacitance

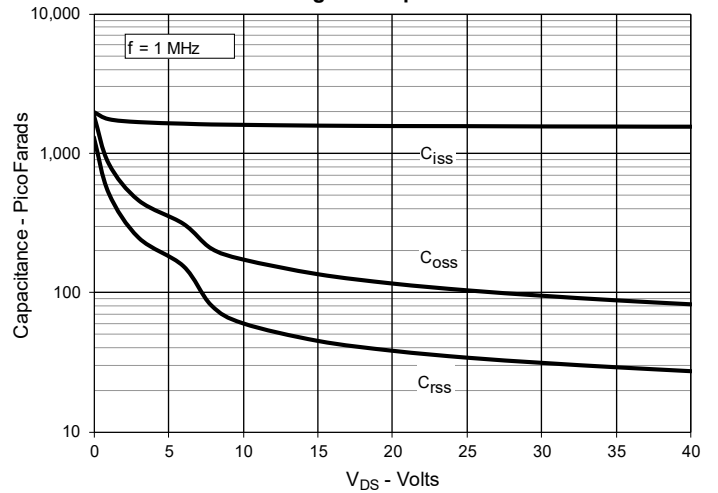

Fig. 11. Breakdown and Threshold Voltages vs. Junction Temperature

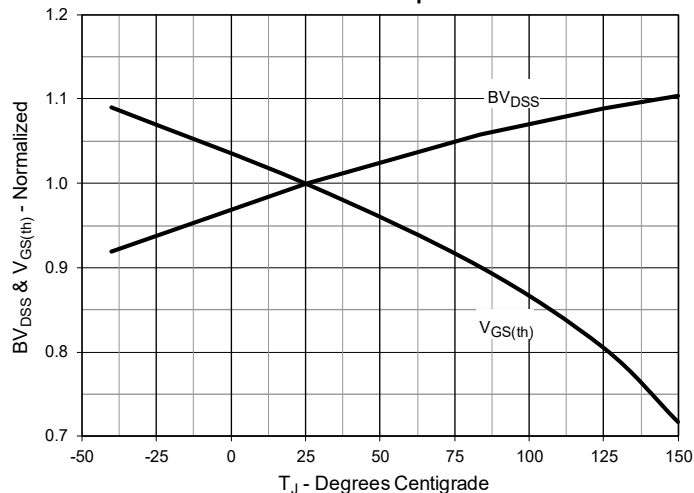

Fig. 12. Forward-Bias Safe Operating Area

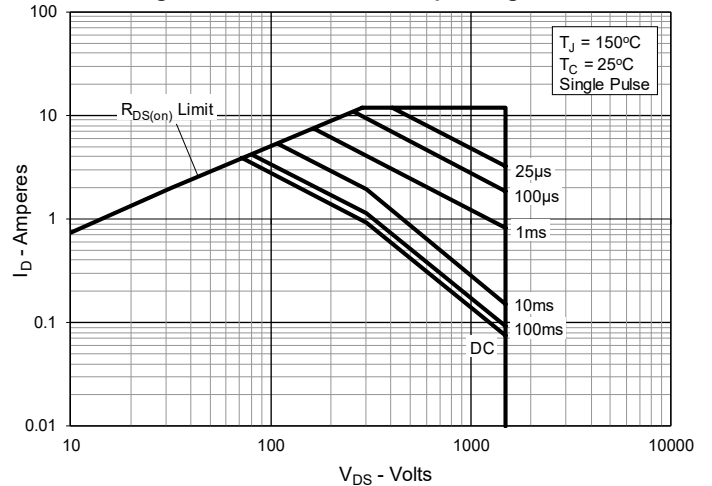
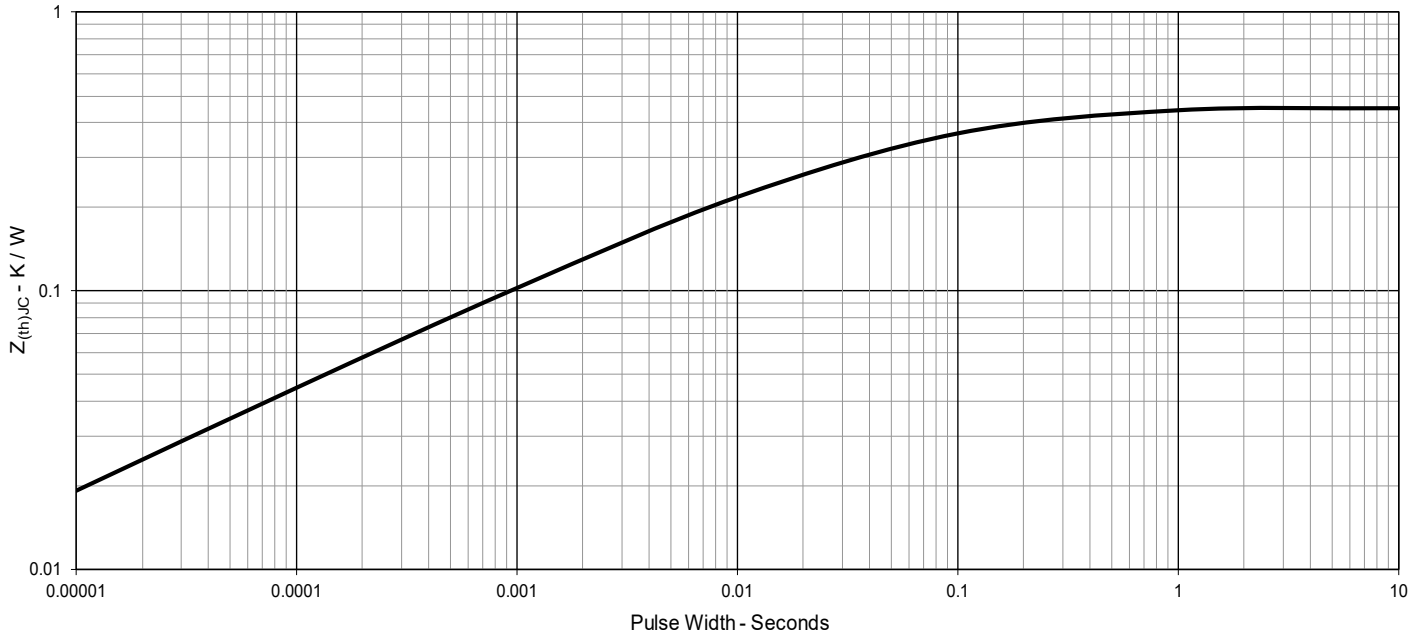
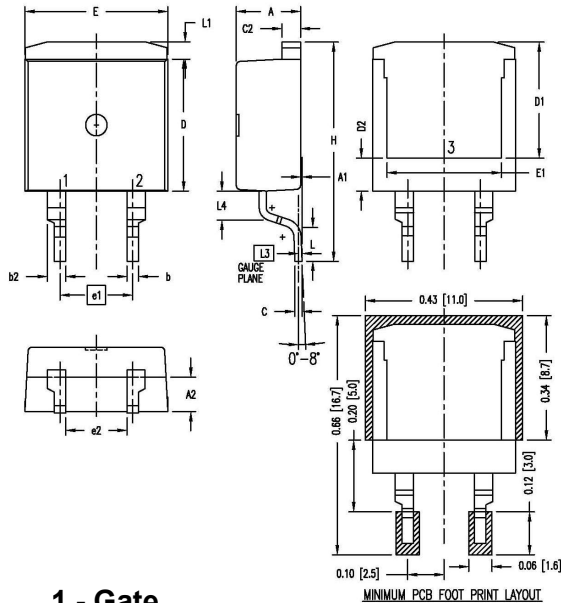

Fig. 13. Maximum Transient Thermal Impedance



Disclaimer Notice - Information furnished is believed to be accurate and reliable. However, users should independently evaluate the suitability of and test each product selected for their own applications. Littelfuse products are not designed for, and may not be used in, all applications. Read complete Disclaimer Notice at www.littelfuse.com/disclaimer-electronics.

TO-263HV Outline

- 1 - Gate**
- 2 - Source**
- 3 - Drain**

SYM	Inches		Millimeters	
	MIN	MAX	MIN	MAX
A	0.170	0.185	4.30	4.70
A1	0.000	0.008	0.00	0.20
A2	0.091	0.098	2.30	2.50
b	0.028	0.035	0.70	0.90
b2	0.046	0.054	1.18	1.38
c	0.018	0.024	0.45	0.60
C2	0.049	0.055	1.25	1.40
D	0.354	0.370	9.00	9.40
D1	0.311	0.327	7.90	8.30
D2	0.083	0.098	2.10	2.50
E	0.386	0.402	9.80	10.20
E1	0.307	0.323	7.80	8.20
e1	0.200	BSC	5.08	BSC
e (2)	0.163	0.174	4.13	4.43
H	0.591	0.614	15.00	15.60
L	0.079	0.102	2.00	2.60
L1	0.039	0.055	1.00	1.40
L3	0.100	BSC	0.254	BSC
L4	0.071	0.087	1.80	2.20

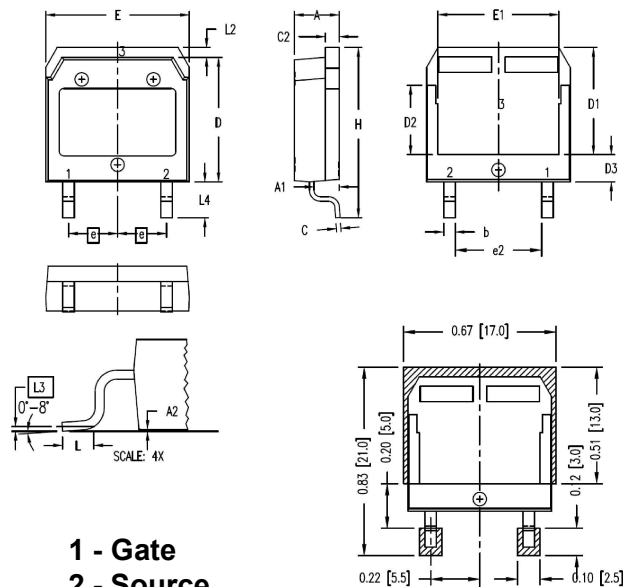
TO-268HV Outline

- 1 - Gate**
- 2 - Source**
- 3 - Drain**

SYM	Inches		Millimeters	
	MIN	MAX	MIN	MAX
A	0.193	0.201	4.90	5.10
A1	0.106	0.114	2.70	2.90
A2	0.001	0.010	0.02	0.25
b	0.045	0.057	1.15	1.45
C	0.016	0.026	0.40	0.65
C2	0.057	0.063	1.45	1.60
D	0.543	0.551	13.80	14.00
D1	0.465	0.476	11.80	12.10
D2	0.295	0.307	7.50	7.80
D3	0.114	0.126	2.90	3.20
E	0.624	0.632	15.85	16.05
E1	0.524	0.535	13.30	13.60
e	0.215	BSC	5.45	BSC
e (2)	0.374	0.386	9.50	9.80
H	0.736	0.752	18.70	19.10
L	0.067	0.079	1.70	2.00
L2	0.039	0.045	1.00	1.15
L3	0.010	BSC	0.25	BSC
L4	0.150	0.161	3.80	4.10