

PolarHT™ Power MOSFET

IXTQ 74N20P
IXTT 74N20P

$V_{DSS} = 200 \text{ V}$
 $I_{D25} = 74 \text{ A}$
 $R_{DS(on)} \leq 34 \text{ m}\Omega$

N-Channel Enhancement Mode
Avalanche Rated



Symbol	Test Conditions	Maximum Ratings	
V_{DSS}	$T_J = 25^\circ\text{C to } 175^\circ\text{C}$	200	V
V_{DGR}	$T_J = 25^\circ\text{C to } 175^\circ\text{C}; R_{GS} = 1 \text{ M}\Omega$	200	V
V_{GSS}	Continuous	± 20	V
V_{GSM}	Transient	± 30	V
I_{D25}	$T_C = 25^\circ\text{C}$	74	A
I_{DM}	$T_C = 25^\circ\text{C}$, pulse width limited by T_{JM}	200	A
I_{AR}	$T_C = 25^\circ\text{C}$	60	A
E_{AR}	$T_C = 25^\circ\text{C}$	40	mJ
E_{AS}	$T_C = 25^\circ\text{C}$	1.0	J
dv/dt	$I_S \leq I_{DM}$, $di/dt \leq 100 \text{ A}/\mu\text{s}$, $V_{DD} \leq V_{DSS}$, $T_J \leq 150^\circ\text{C}$, $R_G = 4 \Omega$	10	V/ns
P_D	$T_C = 25^\circ\text{C}$	480	W
T_J		-55 ... +175	$^\circ\text{C}$
T_{JM}		175	$^\circ\text{C}$
T_{stg}		-55 ... +150	$^\circ\text{C}$
T_L	1.6 mm (0.062 in.) from case for 10 s	300	$^\circ\text{C}$
T_{SOLD}	Plastic body for 10 s	260	$^\circ\text{C}$
M_d	Mounting torque (TO-3P)	1.13/10	Nm/lb.in.
Weight	TO-3P	5.5	g
	TO-268	5.0	g

TO-3P (IXTQ)

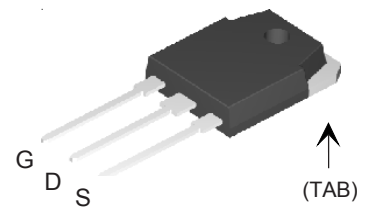

TO-268 (IXTT)



G = Gate D = Drain
S = Source TAB = Drain

Features

- † International standard packages
- † Unclamped Inductive Switching (UIS) rated
- † Low package inductance
- easy to drive and to protect

Advantages

- † Easy to mount
- † Space savings
- † High power density

Symbol	Test Conditions ($T_J = 25^\circ\text{C}$, unless otherwise specified)	Characteristic Values		
		Min.	Typ.	Max.
BV_{DSS}	$V_{GS} = 0 \text{ V}$, $I_D = 250 \mu\text{A}$	200		V
$V_{GS(th)}$	$V_{DS} = V_{GS}$, $I_D = 250 \mu\text{A}$	2.5		5.0 V
I_{GSS}	$V_{GS} = \pm 20 \text{ V}_{DC}$, $V_{DS} = 0$			$\pm 100 \text{ nA}$
I_{DSS}	$V_{DS} = V_{DSS}$ $V_{GS} = 0 \text{ V}$ $T_J = 125^\circ\text{C}$			25 μA
				250 μA
$R_{DS(on)}$	$V_{GS} = 10 \text{ V}$, $I_D = 0.5 I_{D25}$ Pulse test, $t \leq 300 \mu\text{s}$, duty cycle $d \leq 2\%$			34 $\text{m}\Omega$

Symbol	Test Conditions	Characteristic Values		
		$(T_J = 25^\circ\text{C}, \text{ unless otherwise specified})$		
		Min.	Typ.	Max.
g_{fs}	$V_{DS} = 10\text{ V}; I_D = 0.5 I_{D25}, \text{ pulse test}$	30	44	S
C_{iss}	$V_{GS} = 0\text{ V}, V_{DS} = 25\text{ V}, f = 1\text{ MHz}$		3300	pF
C_{oss}			800	pF
C_{rss}			190	pF
$t_{d(on)}$	$V_{GS} = 10\text{ V}, V_{DS} = 0.5 V_{DSS}, I_D = I_{D25}$ $R_G = 4\ \Omega \text{ (External)}$		23	ns
t_r			21	ns
$t_{d(off)}$			60	ns
t_f			21	ns
$Q_{g(on)}$	$V_{GS} = 10\text{ V}, V_{DS} = 0.5 V_{DSS}, I_D = 0.5 I_{D25}$		107	nC
Q_{gs}			24	nC
Q_{gd}			52	nC
R_{thJC}	(TO-3P)			0.31°C/W
R_{thCS}			0.21	$^\circ\text{C/W}$

Symbol	Test Conditions	Characteristic Values		
		$(T_J = 25^\circ\text{C}, \text{ unless otherwise specified})$		
		Min.	Typ.	Max.
I_s	$V_{GS} = 0\text{ V}$			74 A
I_{SM}	Repetitive			180 A
V_{SD}	$I_F = I_s, V_{GS} = 0\text{ V},$ Pulse test, $t \leq 300\ \mu\text{s}, \text{ duty cycle } d \leq 2\%$			1.5 V
t_{rr}	$I_F = 25\text{ A}, -di/dt = 100\text{ A}/\mu\text{s}$ $V_R = 100\text{ V}, V_{GS} = 0\text{ V}$		160	ns
Q_{RM}			3.0	μC

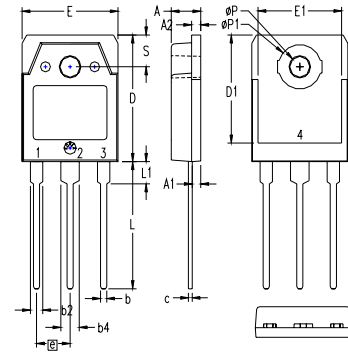
TO-3P (IXTQ) Outline

- 1 - GATE
- 2 - DRAIN (COLLECTOR)
- 3 - SOURCE (EMITTER)
- 4 - DRAIN (COLLECTOR)

SYM	INCHES		MILLIMETERS	
	MIN	MAX	MIN	MAX
A	.185	.193	4.70	4.90
A1	.051	.059	1.30	1.50
A2	.057	.065	1.45	1.65
b	.035	.045	0.90	1.15
b2	.075	.087	1.90	2.20
b4	.114	.126	2.90	3.20
c	.022	.031	0.55	0.80
D	.780	.799	19.80	20.30
D1	.665	.677	16.90	17.20
E	.610	.622	15.50	15.80
E1	.531	.539	13.50	13.70
e	.215 BSC		5.45 BSC	
L	.779	.795	19.80	20.20
L1	.134	.142	3.40	3.60
ϕP	.126	.134	3.20	3.40
$\phi P1$.272	.280	6.90	7.10
S	.193	.201	4.90	5.10

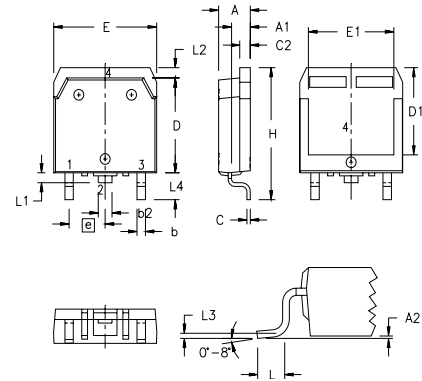
TO-268 Outline

SYM	INCHES		MILLIMETERS	
	MIN	MAX	MIN	MAX
A	.193	.201	4.90	5.10
A1	.106	.114	2.70	2.90
A2	.001	.010	0.02	0.25
b	.045	.057	1.15	1.45
b2	.075	.083	1.90	2.10
C	.016	.026	0.40	0.65
C2	.057	.063	1.45	1.60
D	.543	.551	13.80	14.00
D1	.488	.500	12.40	12.70
E	.624	.632	15.85	16.05
E1	.524	.535	13.30	13.60
e	.215 BSC		5.45 BSC	
H	.736	.752	18.70	19.10
L	.094	.106	2.40	2.70
L1	.047	.055	1.20	1.40
L2	.039	.045	1.00	1.15
L3	.010 BSC		0.25 BSC	
L4	.150	.161	3.80	4.10

IXYS reserves the right to change limits, test conditions, and dimensions.

IXYS MOSFETs and IGBTs are covered by 4,835,592 4,931,844 5,049,961 5,237,481 6,162,665 6,404,065 B1 6,683,344 6,727,585
 one or more of the following U.S. patents: 4,850,072 5,017,508 5,063,307 5,381,025 6,259,123 B1 6,534,343 6,710,405 B2 6,759,692
 4,881,106 5,034,796 5,187,117 5,486,715 6,306,728 B1 6,583,505 6,710,463 6,771,478 B2

Fig. 1. Output Characteristics
@ 25°C

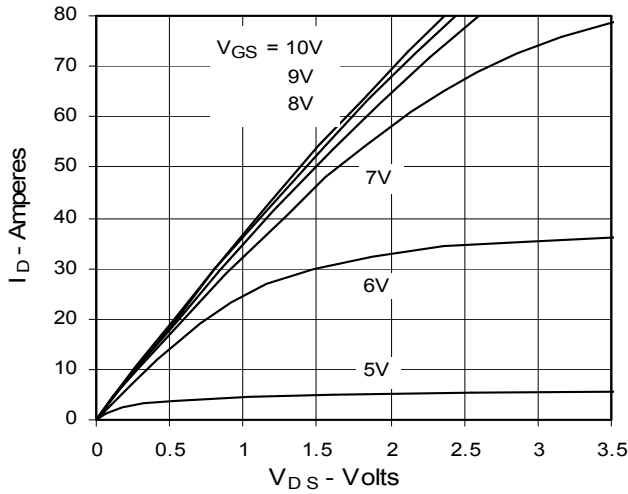

Fig. 2. Extended Output Characteristics
@ 25°C

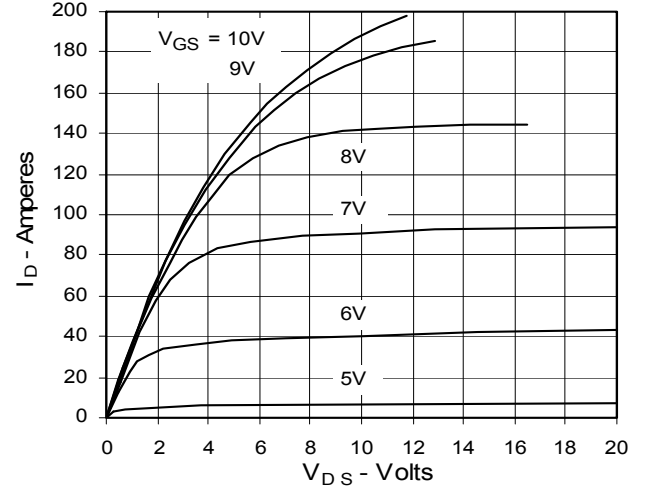

Fig. 3. Output Characteristics
@ 150°C

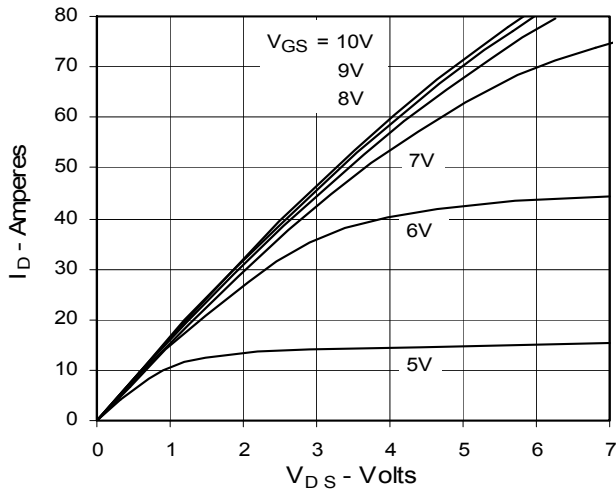

Fig. 4. $R_{DS(on)}$ Normalized to 0.5 I_{D25} Value vs. Junction Temperature

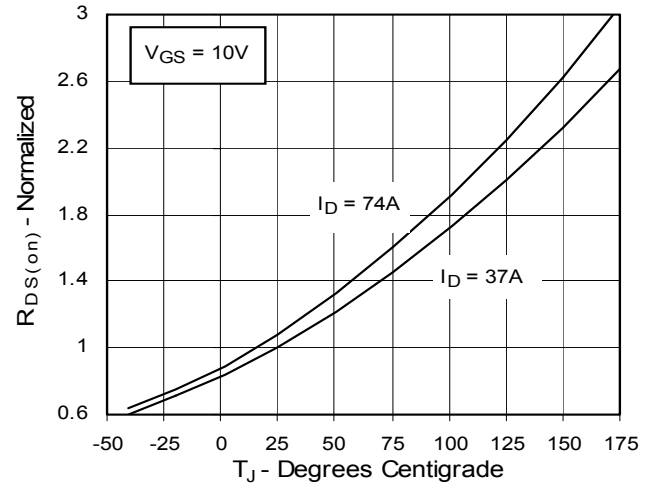

Fig. 5. $R_{DS(on)}$ Normalized to 0.5 I_{D25} Value vs. I_D

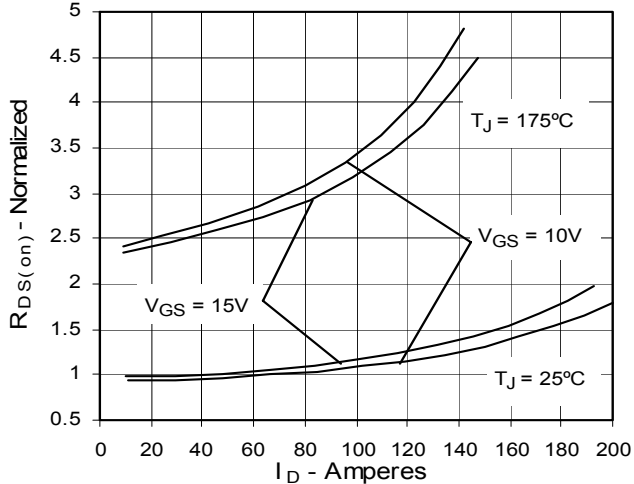

Fig. 6. Drain Current vs. Case Temperature

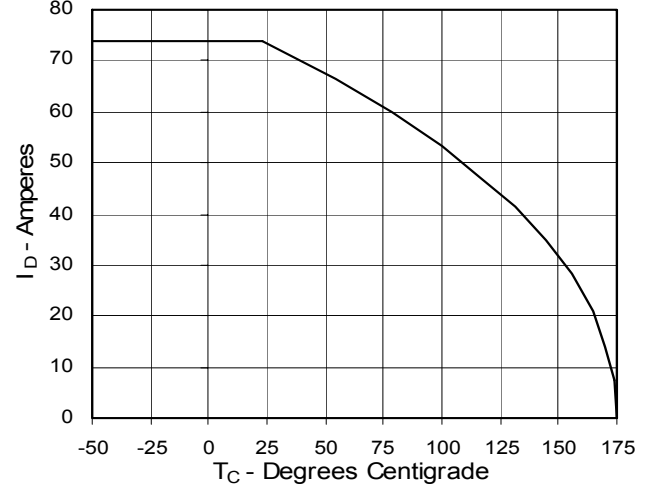

Fig. 7. Input Admittance

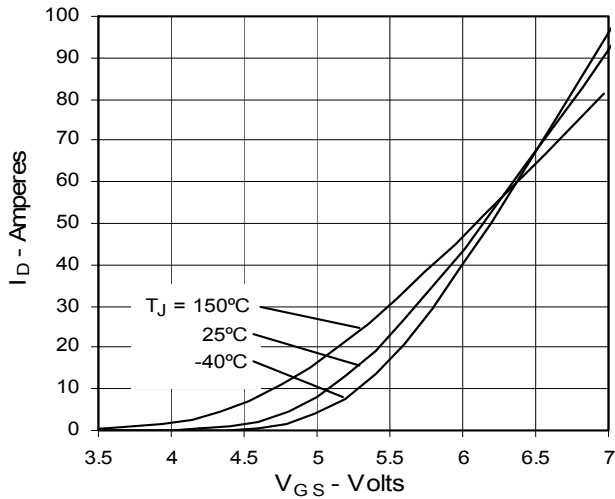

Fig. 8. Transconductance

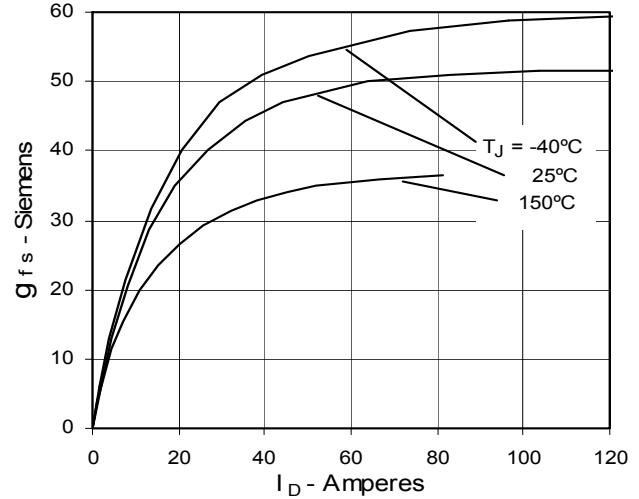

Fig. 9. Source Current vs. Source-To-Drain Voltage

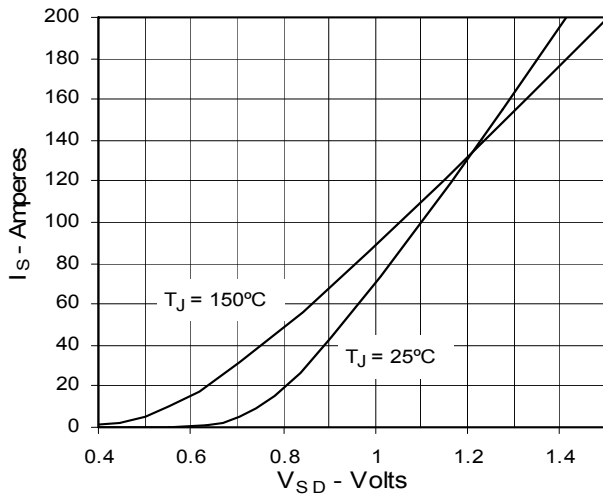

Fig. 10. Gate Charge

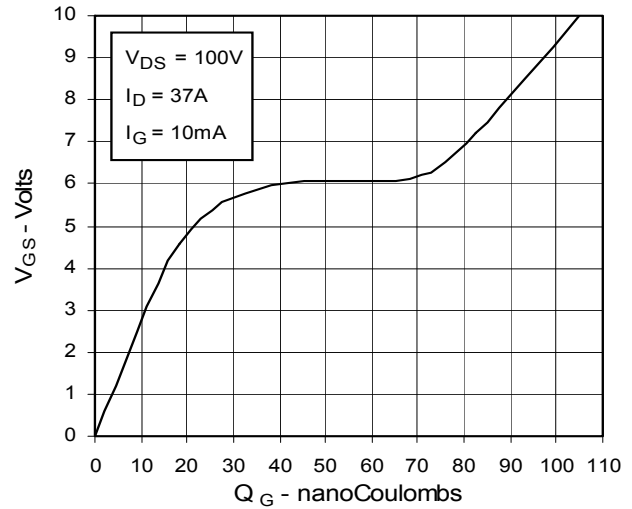

Fig. 11. Capacitance

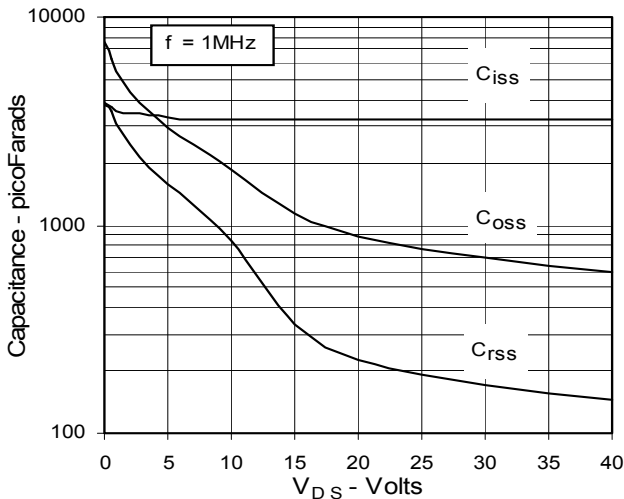

Fig. 12. Forward-Bias Safe Operating Area

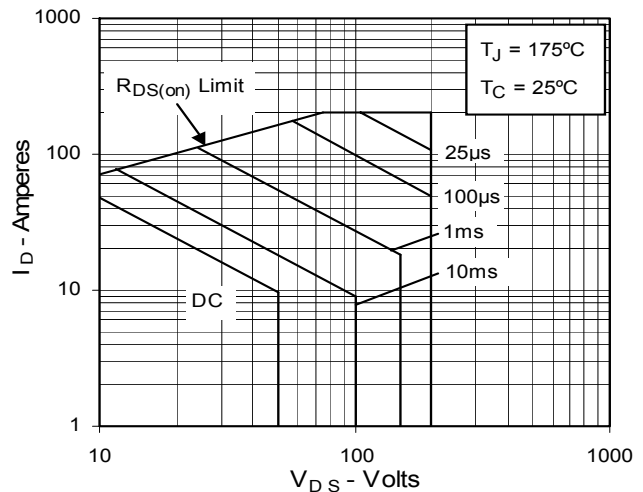
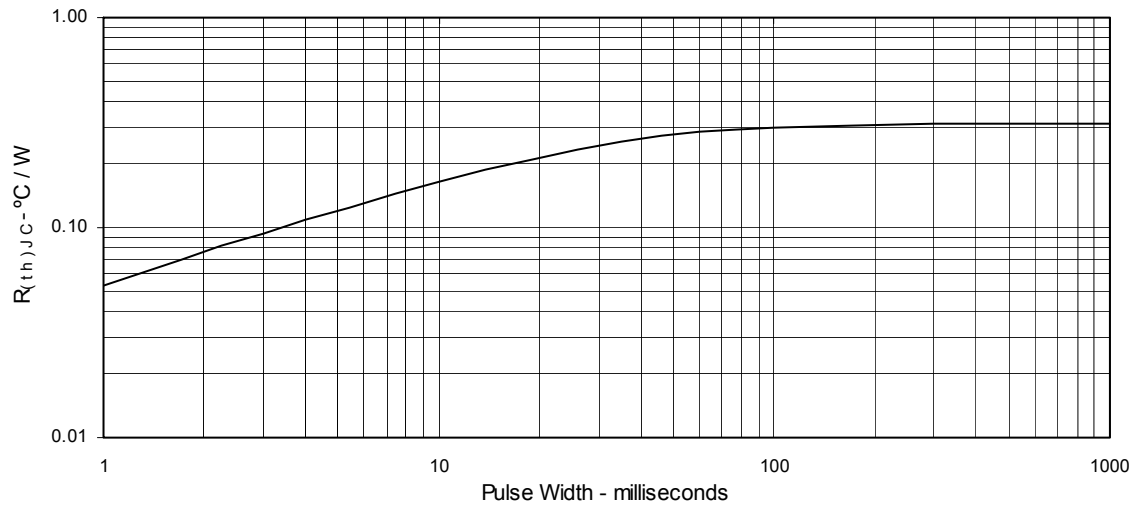

Fig. 13. Maximum Transient Thermal Resistance



Disclaimer Notice - Information furnished is believed to be accurate and reliable. However, users should independently evaluate the suitability of and test each product selected for their own applications. Littelfuse products are not designed for, and may not be used in, all applications. Read complete Disclaimer Notice at www.littelfuse.com/disclaimer-electronics.