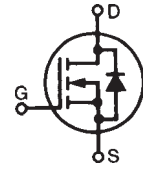


# PolarHV™ Power MOSFET

N-Channel Enhancement Mode  
Avalanche Rated

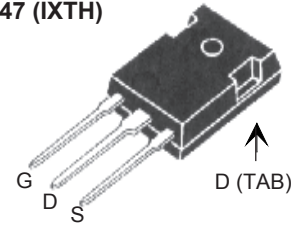
**IXTH 30N60P**  
**IXTQ 30N60P**  
**IXTT 30N60P**  
**IXTV 30N60P**  
**IXTV 30N60PS**

$V_{DSS} = 600 \text{ V}$   
 $I_{D25} = 30 \text{ A}$   
 $R_{DS(on)} \leq 240 \text{ m}\Omega$

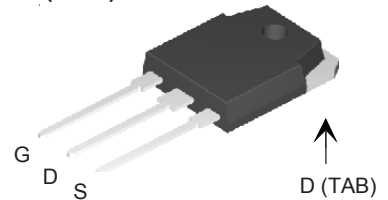


Symbol	Test Conditions	Maximum Ratings	
$V_{DSS}$	$T_J = 25^\circ\text{C}$ to $150^\circ\text{C}$	600	V
$V_{DGR}$	$T_J = 25^\circ\text{C}$ to $150^\circ\text{C}$ ; $R_{GS} = 1 \text{ M}\Omega$	600	V
$V_{GSS}$	Continuous	$\pm 30$	V
$V_{GSM}$	Transient	$\pm 40$	V
$I_{D25}$	$T_C = 25^\circ\text{C}$	30	A
$I_{DM}$	$T_C = 25^\circ\text{C}$ , pulse width limited by $T_{JM}$	80	A
$I_{AR}$	$T_C = 25^\circ\text{C}$	30	A
$E_{AR}$	$T_C = 25^\circ\text{C}$	50	mJ
$E_{AS}$	$T_C = 25^\circ\text{C}$	1.5	J
$dv/dt$	$I_S \leq I_{DM}$ , $di/dt \leq 100 \text{ A}/\mu\text{s}$ , $V_{DD} \leq V_{DSS}$ , $T_J \leq 150^\circ\text{C}$ , $R_G = 4 \Omega$	10	V/ns
$P_D$	$T_C = 25^\circ\text{C}$	540	W
$T_J$		-55 ... +150	$^\circ\text{C}$
$T_{JM}$		150	$^\circ\text{C}$
$T_{stg}$		-55 ... +150	$^\circ\text{C}$
$T_L$	1.6 mm (0.062 in.) from case for 10 s	300	$^\circ\text{C}$
$T_{SOLD}$	Plastic body for 10 s	260	$^\circ\text{C}$
$M_d$	Mounting torque (TO-3P, TO-247)	1.13/10	Nm/lb.in.
$F_C$	Mounting force (PLUS220)	11..65/2.5..15	N/lb.
Weight	TO-247	6.0	g
	TO-3P	5.5	g
	PLUS220	4.0	g
	TO-268	5.0	g

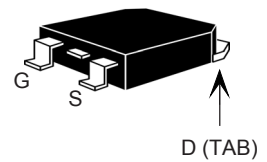
TO-247 (IXTH)



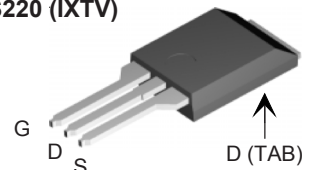
TO-3P (IXTQ)



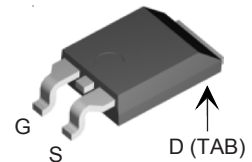
TO-268 (IXTT)



PLUS220 (IXTV)



PLUS220 (IXTV...S)



G = Gate      D = Drain  
S = Source    TAB = Drain

### Features

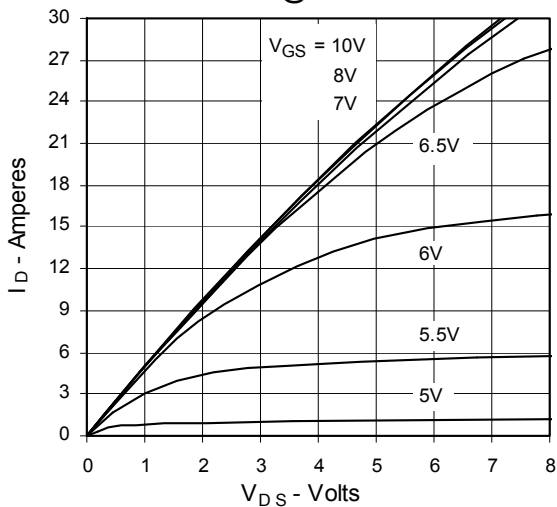
- <sup>1</sup> Fast Recovery diode
- <sup>1</sup> Unclamped Inductive Switching (UIS) rated
- <sup>1</sup> International standard packages
- <sup>1</sup> Low package inductance
- easy to drive and to protect

Symbol	Test Conditions ( $T_J = 25^\circ\text{C}$ , unless otherwise specified)	Characteristic Values		
		Min.	Typ.	Max.
$BV_{DSS}$	$V_{GS} = 0 \text{ V}$ , $I_D = 250 \mu\text{A}$	600		V
$V_{GS(th)}$	$V_{DS} = V_{GS}$ , $I_D = 250 \mu\text{A}$	3.0		V
$I_{GSS}$	$V_{GS} = \pm 30 \text{ V}$ , $V_{DS} = 0$			$\pm 100 \text{ nA}$
$I_{DSS}$	$V_{DS} = V_{DSS}$			25 $\mu\text{A}$
	$V_{GS} = 0 \text{ V}$ $T_J = 125^\circ\text{C}$			250 $\mu\text{A}$
$R_{DS(on)}$	$V_{GS} = 10 \text{ V}$ , $I_D = 0.5 I_{D25}$ Pulse test, $t \leq 300 \mu\text{s}$ , duty cycle $d \leq 2\%$			240 $\text{m}\Omega$

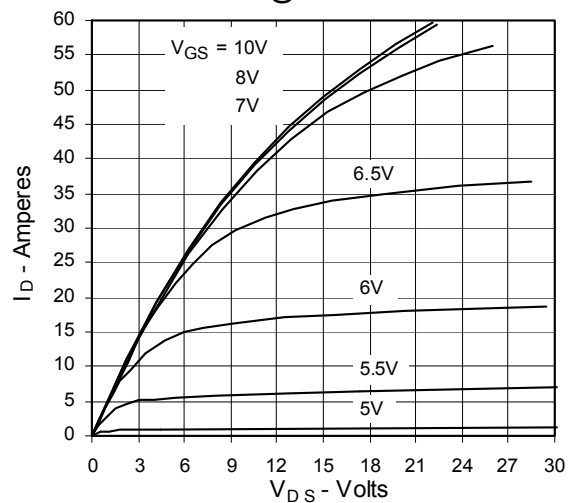
Symbol	Test Conditions	Characteristic Values		
		(T <sub>J</sub> = 25° C, unless otherwise specified)		
		Min.	Typ.	Max.
<b>g<sub>fs</sub></b>	V <sub>DS</sub> = 20 V; I <sub>D</sub> = 0.5 I <sub>D25</sub> , pulse test	22	25	S
<b>C<sub>iss</sub></b>			5050	pF
<b>C<sub>oss</sub></b>	V <sub>GS</sub> = 0 V, V <sub>DS</sub> = 25 V, f = 1 MHz		540	pF
<b>C<sub>rss</sub></b>			53	pF
<b>t<sub>d(on)</sub></b>			29	ns
<b>t<sub>r</sub></b>	V <sub>GS</sub> = 10 V, V <sub>DS</sub> = 0.5 I <sub>D25</sub>		20	ns
<b>t<sub>d(off)</sub></b>	R <sub>G</sub> = 4 Ω (External)		80	ns
<b>t<sub>f</sub></b>			25	ns
<b>Q<sub>g(on)</sub></b>			82	nC
<b>Q<sub>gs</sub></b>	V <sub>GS</sub> = 10 V, V <sub>DS</sub> = 0.5 V <sub>DSS</sub> , I <sub>D</sub> = 0.5 I <sub>D25</sub>		28	nC
<b>Q<sub>gd</sub></b>			30	nC
<b>R<sub>thJC</sub></b>				0.23 °C/W
<b>R<sub>thCS</sub></b>		0.21		°C/W

Source-Drain Diode		Characteristic Values		
		(T <sub>J</sub> = 25° C, unless otherwise specified)		
Symbol	Test Conditions	Min.	Typ.	Max.
<b>I<sub>S</sub></b>	V <sub>GS</sub> = 0 V			30 A
<b>I<sub>SM</sub></b>	Repetitive			80 A
<b>V<sub>SD</sub></b>	I <sub>F</sub> = I <sub>S</sub> , V <sub>GS</sub> = 0 V, Pulse test, t ≤ 300 μs, duty cycle d ≤ 2 %			1.5 V
<b>t<sub>rr</sub></b>	I <sub>F</sub> = 25A, -di/dt = 100 A/μs		500	ns
<b>Q<sub>RM</sub></b>	V <sub>R</sub> = 100V		4.0	μC

**Fig. 1. Output Characteristics @ 25°C**



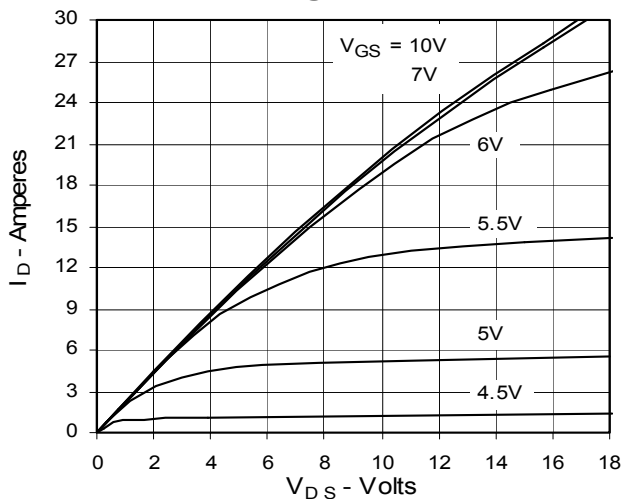
**Fig. 2. Extended Output Characteristics @ 25°C**



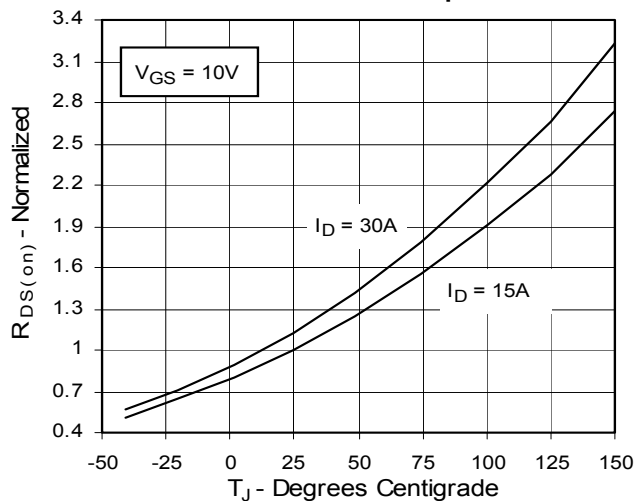
IXYS reserves the right to change limits, test conditions, and dimensions.

IXYS MOSFETs and IGBTs are covered by 4,835,592 4,931,844 5,049,961 5,237,481 6,162,665 6,404,065 B1 6,683,344 6,727,585  
one or more of the following U.S. patents: 4,850,072 5,017,508 5,063,307 5,381,025 6,259,123 B1 6,534,343 6,710,405B2 6,759,692  
4,881,106 5,034,796 5,187,117 5,486,715 6,306,728 B1 6,583,505 6,710,463 6,771,478 B2

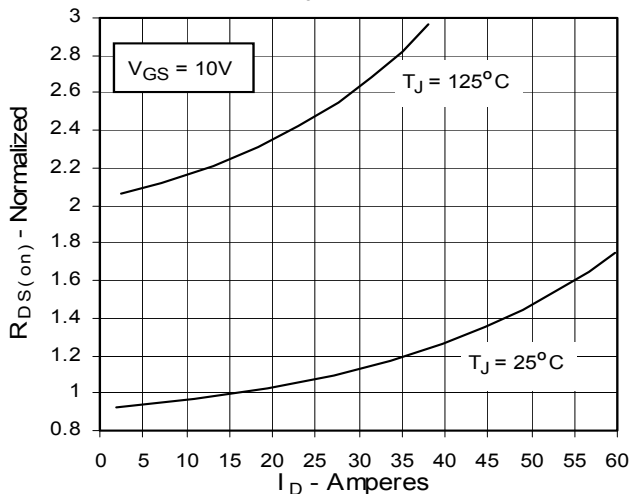
**Fig. 3. Output Characteristics  
@ 125°C**



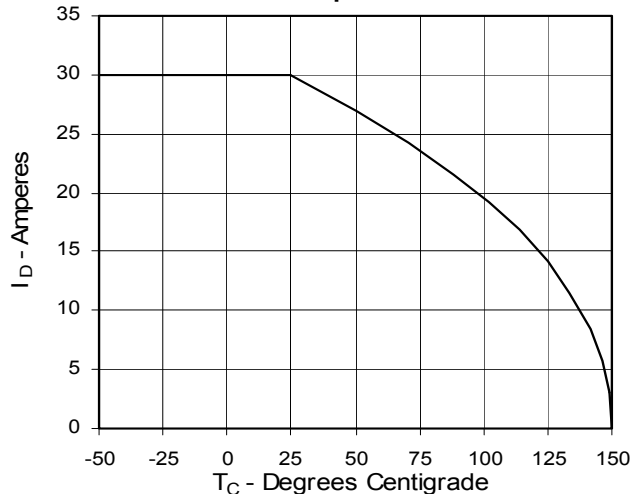
**Fig. 4.  $R_{DS(on)}$  Normalized to 0.5  $I_{D25}$   
Value vs. Junction Temperature**



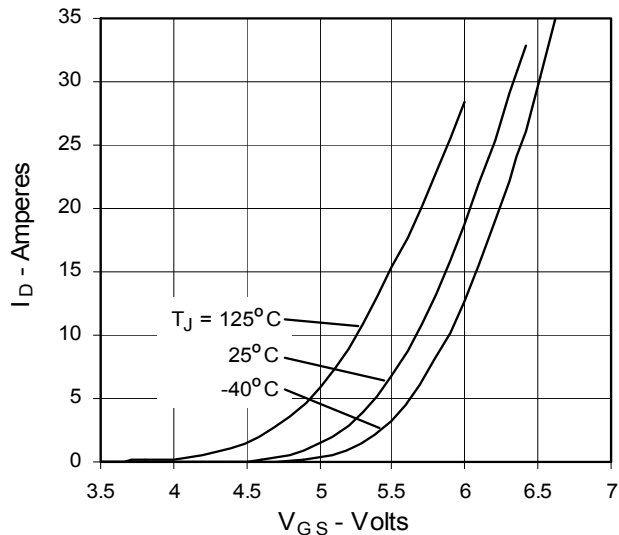
**Fig. 5.  $R_{DS(on)}$  Normalized to  
0.5  $I_{D25}$  Value vs.  $I_D$**



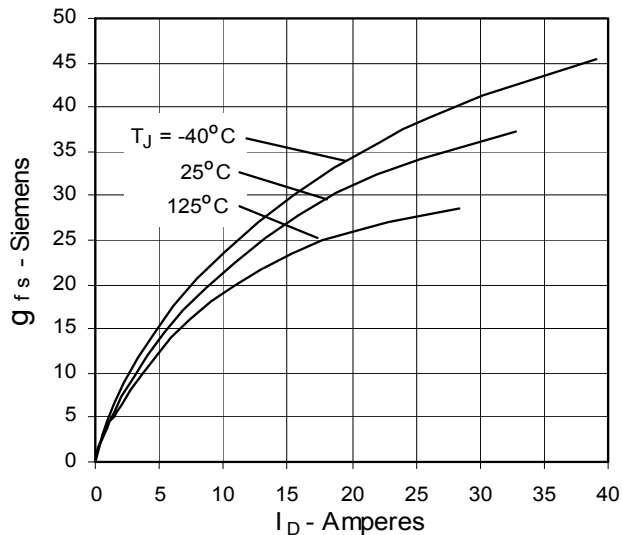
**Fig. 6. Drain Current vs. Case  
Temperature**



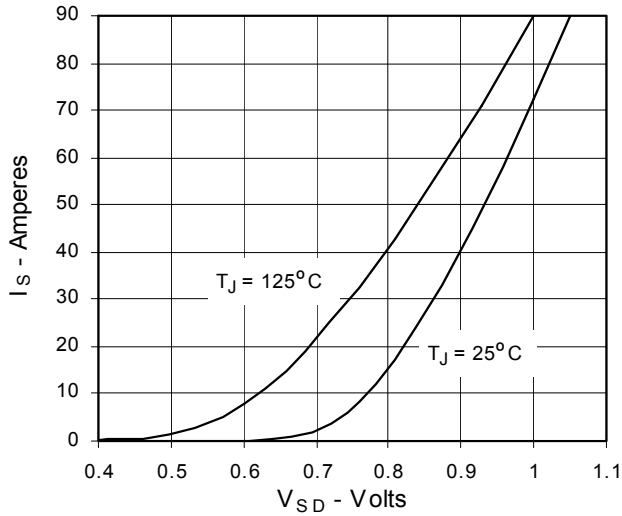
**Fig. 7. Input Admittance**



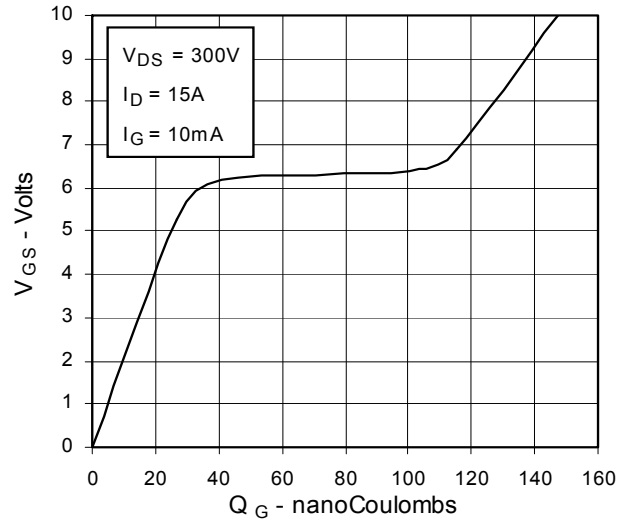
**Fig. 8. Transconductance**



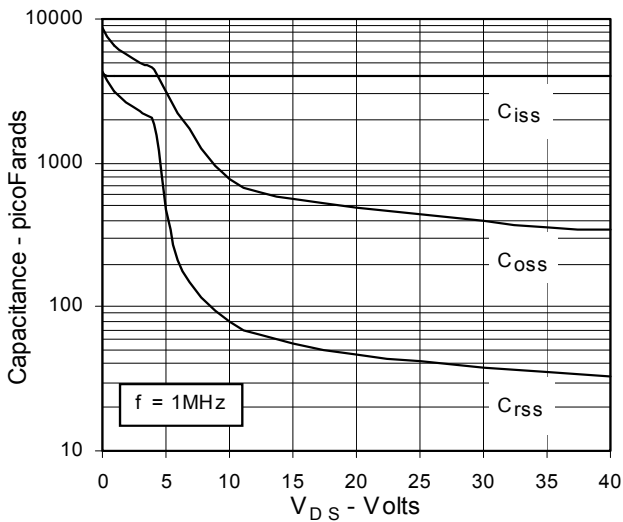
**Fig. 9. Source Current vs. Source-To-Drain Voltage**



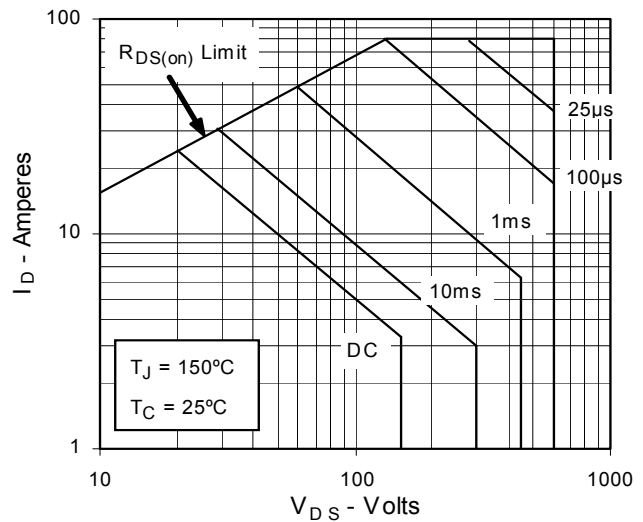
**Fig. 10. Gate Charge**



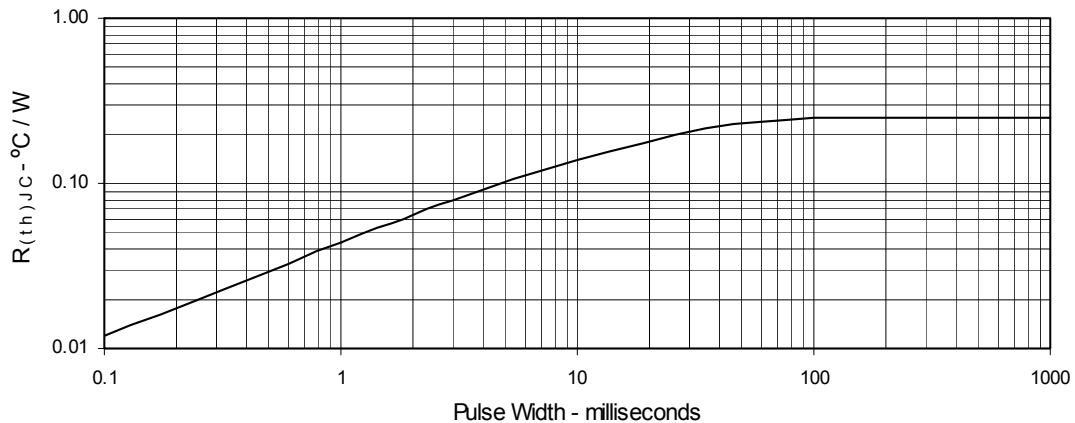
**Fig. 11. Capacitance**



**Fig. 12. Forward-Bias Safe Operating Area**

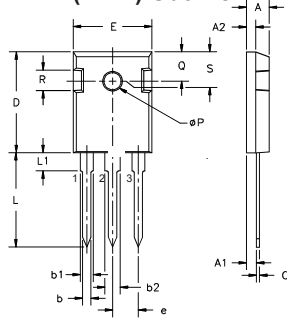


**Fig. 13. Maximum Transient Thermal Resistance**



**Package Outline Drawings**

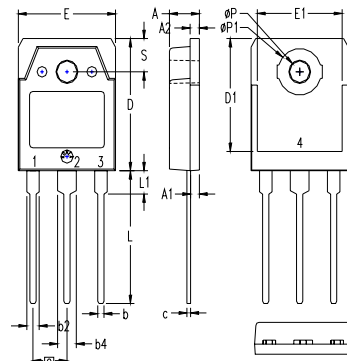
**TO-247AD (IXTH) Outline**



Terminals: 1 - Gate 2 - Drain  
3 - Source Tab - Drain

Dim.	Millimeter		Inches	
	Min.	Max.	Min.	Max.
A	4.7	5.3	.185	.209
A <sub>1</sub>	2.2	2.54	.087	.102
A <sub>2</sub>	2.2	2.6	.059	.098
b	1.0	1.4	.040	.055
b <sub>1</sub>	1.65	2.13	.065	.084
b <sub>2</sub>	2.87	3.12	.113	.123
C	.4	.8	.016	.031
D	20.80	21.46	.819	.845
E	15.75	16.26	.610	.640
e	5.20	5.72	0.205	0.225
L	19.81	20.32	.780	.800
L <sub>1</sub>		4.50		.177
∅P	3.55	3.65	.140	.144
Q	5.89	6.40	0.232	0.252
R	4.32	5.49	.170	.216
S	6.15	BSC	242	BSC

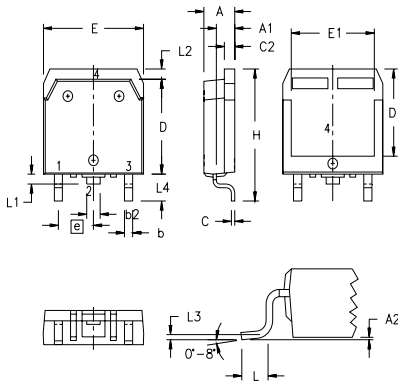
**TO-3P (IXTQ) Outline**



1 - GATE  
2 - DRAIN (COLLECTOR)  
3 - SOURCE (EMITTER)  
4 - DRAIN (COLLECTOR)

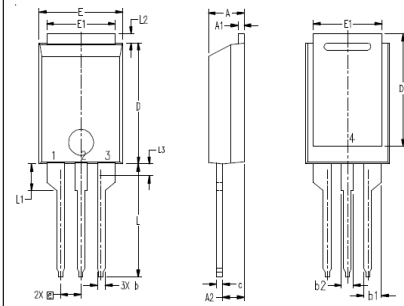
SYM	INCHES		MILLIMETERS	
	MIN	MAX	MIN	MAX
A	.185	.193	4.70	4.90
A <sub>1</sub>	.051	.059	1.30	1.50
A <sub>2</sub>	.057	.065	1.45	1.65
b	.035	.045	0.90	1.15
b <sub>2</sub>	.075	.087	1.90	2.20
b <sub>4</sub>	.114	.126	2.90	3.20
c	.022	.031	0.55	0.80
D	.780	.799	19.80	20.30
D <sub>1</sub>	.665	.677	16.90	17.20
E	.610	.622	15.50	15.80
E <sub>1</sub>	.531	.539	13.50	13.70
e	.215 BSC		5.45 BSC	
L	.779	.795	19.80	20.20
L <sub>1</sub>	.134	.142	3.40	3.60
∅P	.126	.134	3.20	3.40
∅P <sub>1</sub>	.272	.280	6.90	7.10
S	.193	.201	4.90	5.10

**TO-268 (IXTT) Outline**



SYM	INCHES		MILLIMETERS	
	MIN	MAX	MIN	MAX
A	.193	.201	4.90	5.10
A <sub>1</sub>	.106	.114	2.70	2.90
A <sub>2</sub>	.001	.010	0.02	0.25
b	.045	.057	1.15	1.45
b <sub>2</sub>	.075	.083	1.90	2.10
C	.016	.026	0.40	0.65
C <sub>2</sub>	.057	.063	1.45	1.60
D	5.43	5.51	13.80	14.00
D <sub>1</sub>	4.88	5.00	12.40	12.70
E	6.24	6.32	15.85	16.05
E <sub>1</sub>	5.24	5.35	13.30	13.60
e	.215 BSC		5.45 BSC	
H	.736	.752	18.70	19.10
L	.094	.106	2.40	2.70
L <sub>1</sub>	.047	.055	1.20	1.40
L <sub>2</sub>	.039	.045	1.00	1.15
L <sub>3</sub>	.010 BSC		0.25 BSC	
L <sub>4</sub>	.150	.161	3.80	4.10

**PLUS220 (IXTV) Outline**

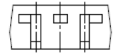
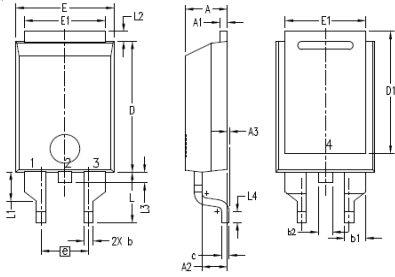


1. GATE  
2. DRAIN (COLLECTOR)  
3. SOURCE (EMITTER)  
4. DRAIN (COLLECTOR)

SYM	INCHES		MILLIMETER	
	MIN	MAX	MIN	MAX
A	.169	.185	4.30	4.70
A <sub>1</sub>	.028	.035	0.70	0.90
A <sub>2</sub>	.098	.118	2.50	3.00
b	.035	.047	0.90	1.20
b <sub>1</sub>	.080	.095	2.03	2.41
b <sub>2</sub>	.054	.064	1.37	1.63
c	.028	.035	0.70	0.90
D	.551	.591	14.00	15.00
D <sub>1</sub>	.512	.539	13.00	13.70
E	.394	.433	10.00	11.00
E <sub>1</sub>	.331	.346	8.40	8.80
e	.100 BSC		2.54 BSC	
L	.512	.551	13.00	14.00
L <sub>1</sub>	.118	.138	3.00	3.50
L <sub>2</sub>	.035	.051	0.90	1.30
L <sub>3</sub>	.047	.059	1.20	1.50

Package Outline Drawings

PLUS220SMD (IXTV\_S) Outline



1. GATE
2. DRAIN (COLLECTOR)
3. SOURCE (EMITTER)
4. DRAIN (COLLECTOR)

SYM	INCHES		MILLIMETER	
	MIN	MAX	MIN	MAX
A	.169	.185	4.30	4.70
A1	.028	.035	0.70	0.90
A2	.098	.118	2.50	3.00
A3	.000	.010	0.00	0.25
b	.035	.047	0.90	1.20
b1	.080	.095	2.03	2.41
b2	.054	.064	1.37	1.63
c	.028	.035	0.70	0.90
D	.551	.591	14.00	15.00
D1	.512	.539	13.00	13.70
E	.394	.433	10.00	11.00
E1	.331	.346	8.40	8.80
e	.200BSC		5.08 BSC	
L	.209	.228	5.30	5.80
L1	.118	.138	3.00	3.50
L2	.035	.051	0.90	1.30
L3	.047	.059	1.20	1.50
L4	.039	.059	1.00	1.50



---

Disclaimer Notice - Information furnished is believed to be accurate and reliable. However, users should independently evaluate the suitability of and test each product selected for their own applications. Littelfuse products are not designed for, and may not be used in, all applications. Read complete Disclaimer Notice at [www.littelfuse.com/disclaimer-electronics](http://www.littelfuse.com/disclaimer-electronics).