

# PolarHV™ Power MOSFET

**IXTQ 26N50P**  
**IXTT 26N50P**  
**IXTV 26N50P**  
**IXTV 26N50PS**

$V_{DSS} = 500 \text{ V}$   
 $I_{D25} = 26 \text{ A}$   
 $R_{DS(on)} \leq 230 \text{ m}\Omega$

N-Channel Enhancement Mode  
Avalanche Rated

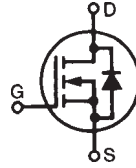

Symbol	Test Conditions	Maximum Ratings	
$V_{DSS}$	$T_J = 25^\circ\text{C}$ to $150^\circ\text{C}$	500	V
$V_{DGR}$	$T_J = 25^\circ\text{C}$ to $150^\circ\text{C}$ ; $R_{GS} = 1 \text{ M}\Omega$	500	V
$V_{GSS}$	Continuos	$\pm 30$	V
$V_{GSM}$	Transient	$\pm 40$	V
$I_{D25}$	$T_C = 25^\circ\text{C}$	26	A
$I_{DM}$	$T_C = 25^\circ\text{C}$ , pulse width limited by $T_{JM}$	78	A
$I_{AR}$	$T_C = 25^\circ\text{C}$	26	A
$E_{AR}$	$T_C = 25^\circ\text{C}$	40	mJ
$E_{AS}$	$T_C = 25^\circ\text{C}$	1.0	J
$dv/dt$	$I_S \leq I_{DM}$ , $di/dt \leq 100 \text{ A}/\mu\text{s}$ , $V_{DD} \leq V_{DSS}$ , $T_J \leq 150^\circ\text{C}$ , $R_G = 4 \Omega$	10	V/ns
$P_D$	$T_C = 25^\circ\text{C}$	400	W
$T_J$		-55 ... +150	$^\circ\text{C}$
$T_{JM}$		150	$^\circ\text{C}$
$T_{stg}$		-55 ... +150	$^\circ\text{C}$
$T_L$	1.6 mm (0.062 in.) from case for 10 s	300	$^\circ\text{C}$
$T_{SOLD}$	Plastic body for 10 s	260	$^\circ\text{C}$
$M_d$	Mounting torque (TO-3P)	1.13/10	Nm/lb.in.
Weight	TO-3P	6	g
	TO-268	5.5	g
	PLUS220 & PLUS220SMD	5	g

TO-3P (IXTQ)

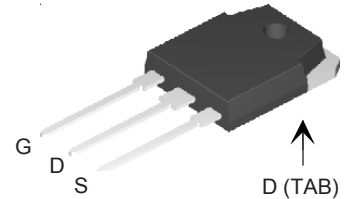

TO-268 (IXTT)

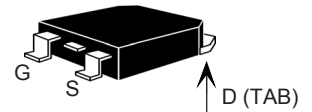

PLUS220 (IXTV)

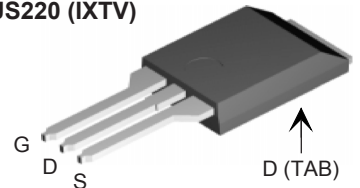

PLUS220SMD (IXTV\_S)

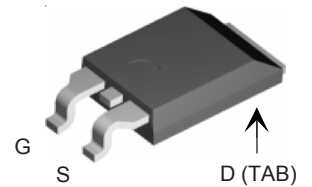

G = Gate      D = Drain  
S = Source      TAB = Drain

Symbol	Test Conditions	Characteristic Values		
		Min.	Typ.	Max.
$BV_{DSS}$	$V_{GS} = 0 \text{ V}$ , $I_D = 250 \mu\text{A}$	500		V
$V_{GS(th)}$	$V_{DS} = V_{GS}$ , $I_D = 250 \mu\text{A}$	3.0		5.5 V
$I_{GSS}$	$V_{GS} = \pm 30 \text{ V}_{DC}$ , $V_{DS} = 0$			$\pm 100 \text{ nA}$
$I_{DSS}$	$V_{DS} = V_{DSS}$			25 $\mu\text{A}$
	$V_{GS} = 0 \text{ V}$ $T_J = 125^\circ\text{C}$			250 $\mu\text{A}$
$R_{DS(on)}$	$V_{GS} = 10 \text{ V}$ , $I_D = 0.5 I_{D25}$ Pulse test, $t \leq 300 \mu\text{s}$ , duty cycle $d \leq 2 \%$			230 $\text{m}\Omega$

## Features

- <sup>1</sup> International standard packages
- <sup>1</sup> Unclamped Inductive Switching (UIS) rated
- <sup>1</sup> Low package inductance
- easy to drive and to protect

## Advantages

- <sup>1</sup> Easy to mount
- <sup>1</sup> Space savings
- <sup>1</sup> High power density

Symbol	Test Conditions	Characteristic Values ( $T_j = 25^\circ\text{C}$ , unless otherwise specified)		
		Min.	Typ.	Max.
$g_{fs}$	$V_{DS} = 20\text{ V}; I_D = 0.5 I_{D25}$ , pulse test	24	31	S
$C_{iss}$	$V_{GS} = 0\text{ V}, V_{DS} = 25\text{ V}, f = 1\text{ MHz}$		3600	pF
$C_{oss}$			380	pF
$C_{rss}$			48	pF
$t_{d(on)}$	$V_{GS} = 10\text{ V}, V_{DS} = 0.5 I_{D25}$ $R_G = 4\ \Omega$ (External)		20	ns
$t_r$			25	ns
$t_{d(off)}$			58	ns
$t_f$			20	ns
$Q_{g(on)}$	$V_{GS} = 10\text{ V}, V_{DS} = 0.5 V_{DSS}, I_D = 0.5 I_{D25}$		65	nC
$Q_{gs}$			18	nC
$Q_{gd}$			20	nC
$R_{thJC}$			0.31	$^\circ\text{C/W}$
$R_{thCS}$		0.21		$^\circ\text{C/W}$

Symbol	Test Conditions	Characteristic Values ( $T_j = 25^\circ\text{C}$ , unless otherwise specified)		
		Min.	Typ.	Max.
$I_S$	$V_{GS} = 0\text{ V}$			26 A
$I_{SM}$	Repetitive			104 A
$V_{SD}$	$I_F = I_S, V_{GS} = 0\text{ V}$ , Pulse test, $t \leq 300\ \mu\text{s}$ , duty cycle $d \leq 2\%$			1.5 V
$t_{rr}$	$I_F = 25\text{ A}, -di/dt = 100\text{ A}/\mu\text{s}$ $V_R = 100\text{ V}, V_{GS} = 0\text{ V}$		300	ns
$Q_{RM}$			3.3	$\mu\text{C}$

**TO-3P (IXTQ) Outline**

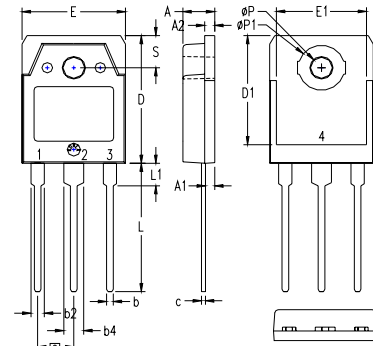

- 1 - GATE
- 2 - DRAIN (COLLECTOR)
- 3 - SOURCE (EMITTER)
- 4 - DRAIN (COLLECTOR)

SYM	INCHES		MILLIMETERS	
	MIN	MAX	MIN	MAX
A	.185	.193	4.70	4.90
A1	.051	.059	1.30	1.50
A2	.057	.065	1.45	1.65
b	.035	.045	0.90	1.15
b2	.075	.087	1.90	2.20
b4	.114	.126	2.90	3.20
c	.022	.031	0.55	0.80
D	.780	.799	19.80	20.30
D1	.665	.677	16.90	17.20
E	.610	.622	15.50	15.80
E1	.531	.539	13.50	13.70
e	.215 BSC		5.45 BSC	
L	.779	.795	19.80	20.20
L1	.134	.142	3.40	3.60
$\phi P$	.126	.134	3.20	3.40
$\phi P1$	.272	.280	6.90	7.10
S	.193	.201	4.90	5.10

**PLUS220 (IXTV) Outline**

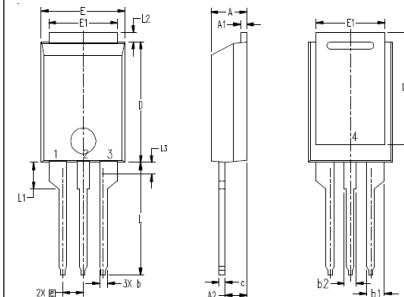

- 1. GATE
- 2. DRAIN (COLLECTOR)
- 3. SOURCE (EMITTER)
- 4. DRAIN (COLLECTOR)

SYM	INCHES		MILLIMETER	
	MIN	MAX	MIN	MAX
A	.169	.185	4.30	4.70
A1	.028	.035	0.70	0.90
A2	.098	.118	2.50	3.00
b	.035	.047	0.90	1.20
b1	.080	.095	2.03	2.41
b2	.054	.064	1.37	1.63
c	.028	.035	0.70	0.90
D	.551	.591	14.00	15.00
D1	.512	.539	13.00	13.70
E	.394	.433	10.00	11.00
E1	.331	.346	8.40	8.80
e	.100 BSC		2.54 BSC	
L	.512	.551	13.00	14.00
L1	.118	.138	3.00	3.50
L2	.035	.051	0.90	1.30
L3	.047	.059	1.20	1.50

**PLUS220SMD (IXTV\_S) Outline**

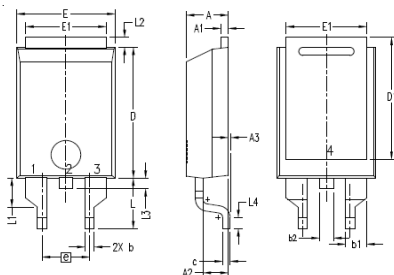

- 1. GATE
- 2. DRAIN (COLLECTOR)
- 3. SOURCE (EMITTER)
- 4. DRAIN (COLLECTOR)

SYM	INCHES		MILLIMETER	
	MIN	MAX	MIN	MAX
A	.169	.185	4.30	4.70
A1	.028	.035	0.70	0.90
A2	.098	.118	2.50	3.00
A3	.000	.010	0.00	0.25
b	.035	.047	0.90	1.20
b1	.080	.095	2.03	2.41
b2	.054	.064	1.37	1.63
c	.028	.035	0.70	0.90
D	.551	.591	14.00	15.00
D1	.512	.539	13.00	13.70
E	.394	.433	10.00	11.00
E1	.331	.346	8.40	8.80
e	.200 BSC		5.08 BSC	
L	.209	.228	5.30	5.80
L1	.118	.138	3.00	3.50
L2	.035	.051	0.90	1.30
L3	.047	.059	1.20	1.50
L4	.039	.059	1.00	1.50

IXYS reserves the right to change limits, test conditions, and dimensions.

IXYS MOSFETs and IGBTs are covered by 4,835,592 4,931,844 5,049,961 5,237,481 6,162,665 6,404,065 B1 6,683,344 6,727,585  
one or more of the following U.S. patents: 4,850,072 5,017,508 5,063,307 5,381,025 6,259,123 B1 6,534,343 6,710,405 B2 6,759,692  
4,881,106 5,034,796 5,187,117 5,486,715 6,306,728 B1 6,583,505 6,710,463 6,771,478 B2

**Fig. 1. Output Characteristics  
@ 25°C**

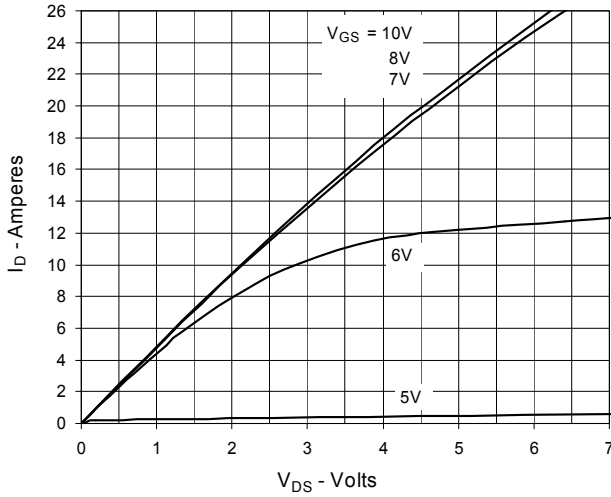

**Fig. 2. Extended Output Characteristics  
@ 25°C**

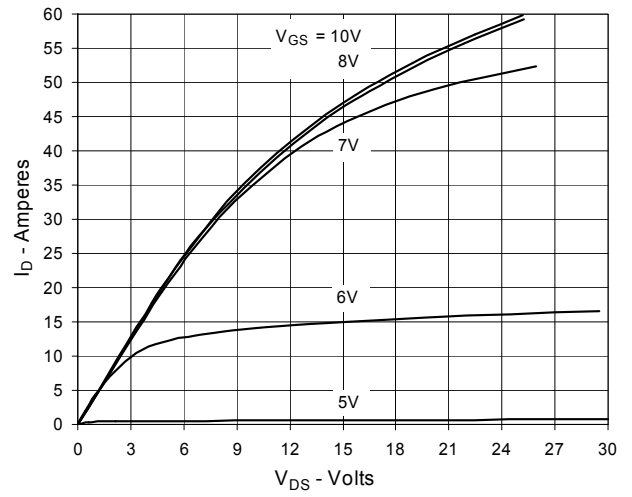

**Fig. 3. Output Characteristics  
@ 125°C**

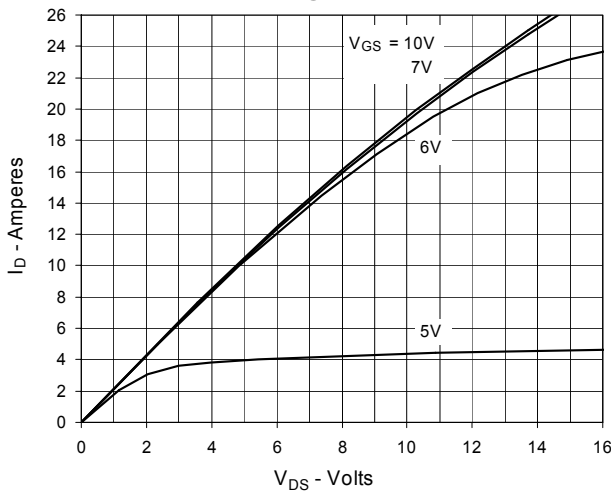

**Fig. 4.  $R_{DS(on)}$  Normalized to  $I_D = 13A$  Value  
vs. Junction Temperature**

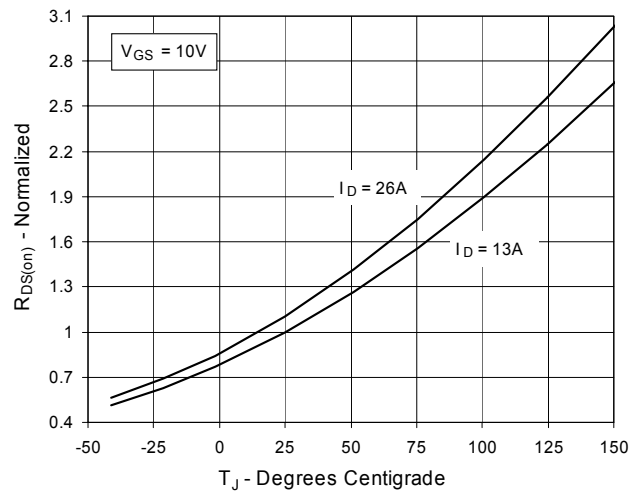

**Fig. 5.  $R_{DS(on)}$  Normalized to  $I_D = 13A$  Value  
vs. Drain Current**

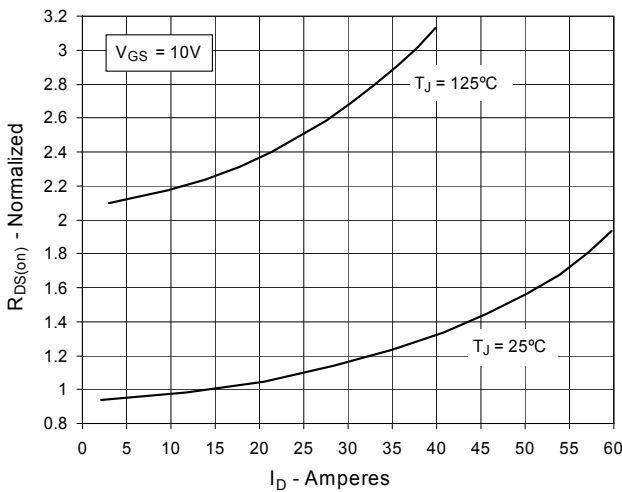

**Fig. 6. Maximum Drain Current vs.  
Case Temperature**

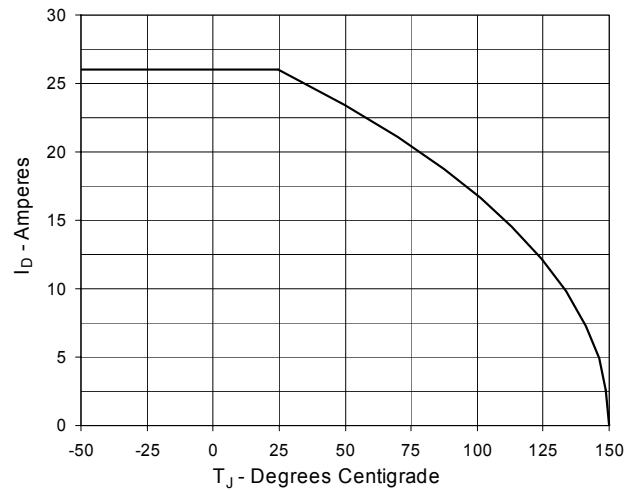

**Fig. 7. Input Admittance**

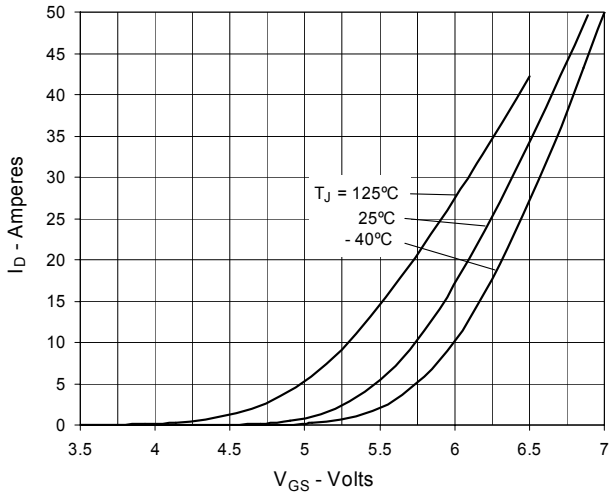

**Fig. 8. Transconductance**

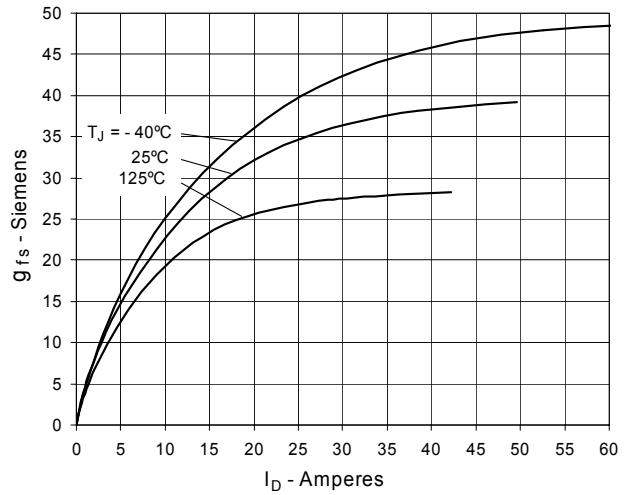

**Fig. 9. Forward Voltage Drop of Intrinsic Diode**

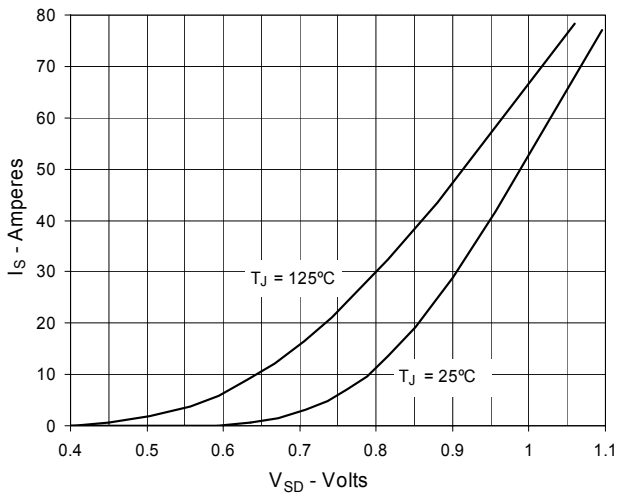

**Fig. 10. Gate Charge**

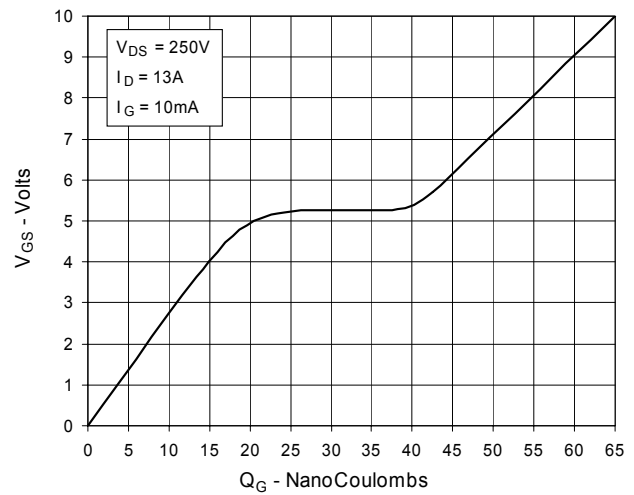

**Fig. 11. Capacitance**

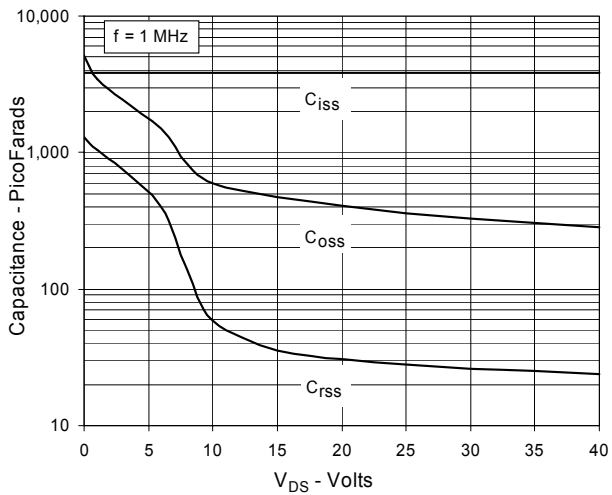

**Fig. 12. Forward-Bias Safe Operating Area**

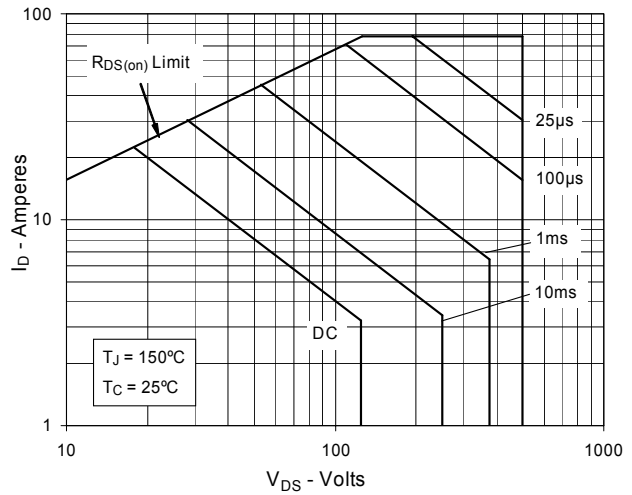
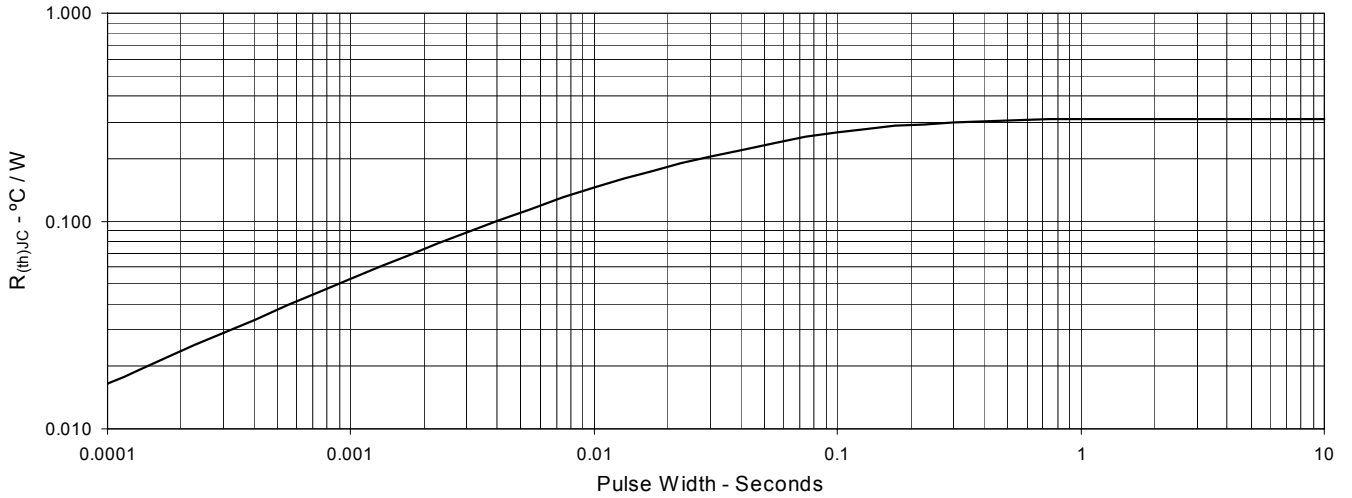
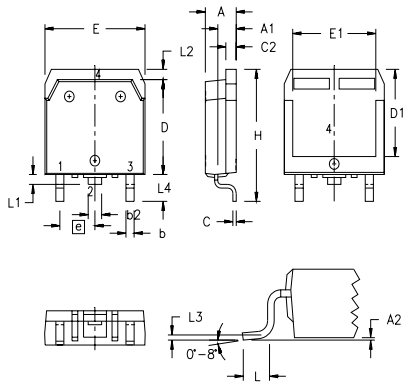

Fig. 13. Maximum Transient Thermal Resistance



TO-268 (IXTT) Outline



SYM	INCHES		MILLIMETERS	
	MIN	MAX	MIN	MAX
A	.193	.201	4.90	5.10
A1	.106	.114	2.70	2.90
A2	.001	.010	0.02	0.25
b	.045	.057	1.15	1.45
b2	.075	.083	1.90	2.10
C	.016	.026	0.40	0.65
C2	.057	.063	1.45	1.60
D	.543	.551	13.80	14.00
D1	.488	.500	12.40	12.70
E	.624	.632	15.85	16.05
E1	.524	.535	13.30	13.60
e	.215 BSC		5.45 BSC	
H	.736	.752	18.70	19.10
L	.094	.106	2.40	2.70
L1	.047	.055	1.20	1.40
L2	.039	.045	1.00	1.15
L3	.010 BSC		0.25 BSC	
L4	.150	.161	3.80	4.10



---

Disclaimer Notice - Information furnished is believed to be accurate and reliable. However, users should independently evaluate the suitability of and test each product selected for their own applications. Littelfuse products are not designed for, and may not be used in, all applications. Read complete Disclaimer Notice at [www.littelfuse.com/disclaimer-electronics](http://www.littelfuse.com/disclaimer-electronics).