

PolarHT™ Power MOSFET

IXTK 100N25P
IXTQ 100N25P
IXTT 100N25P

V_{DSS} = 250 V
I_{D25} = 100 A
R_{DS(on)} ≤ 27 mΩ

N-Channel Enhancement Mode
Avalanche Rated



Symbol	Test Conditions	Maximum Ratings	
V _{DSS}	T _J = 25° C to 150° C	250	V
V _{DGR}	T _J = 25° C to 150° C; R _{GS} = 1 MΩ	250	V
V _{GSS}	Continuous	±20	V
V _{GSM}	Transient	±30	V
I _{D25}	T _C = 25° C	100	A
I _{D(RMS)}	External lead current limit	75	A
I _{DM}	T _C = 25° C, pulse width limited by T _{JM}	250	A
I _{AR}	T _C = 25° C	60	A
E _{AR}	T _C = 25° C	60	mJ
E _{AS}	T _C = 25° C	2.0	J
dv/dt	I _S ≤ I _{DM} , di/dt ≤ 100 A/μs, V _{DD} ≤ V _{DSS} , T _J ≤ 150° C, R _G = 4 Ω	10	V/ns
P _D	T _C = 25° C	600	W
T _J		-55 ... +150	°C
T _{JM}		150	°C
T _{stg}		-55 ... +150	°C
T _L	1.6 mm (0.062 in.) from case for 10 s	300	°C
T _{SOLD}	Plastic body for 10 s	260	°C
M _d	Mounting torque	1.13/10	Nm/lb.in.
Weight	TO-3P	5.5	g
	TO-264	10	g
	TO-268	5.0	g

TO-264 (IXTK)

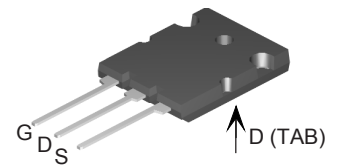

TO-3P (IXTQ)

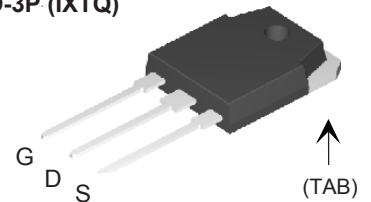

TO-268 (IXTT)

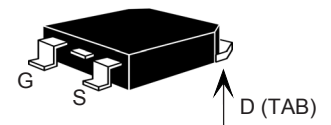

G = Gate D = Drain
S = Source TAB = Drain

Features

- † International standard packages
- † Unclamped Inductive Switching (UIS) rated
- † Low package inductance
- easy to drive and to protect

Advantages

- † Easy to mount
- † Space savings
- † High power density

Symbol	Test Conditions (T _J = 25° C, unless otherwise specified)	Characteristic Values		
		Min.	Typ.	Max.
BV _{DSS}	V _{GS} = 0 V, I _D = 250 μA	250		V
V _{GS(th)}	V _{DS} = V _{GS} , I _D = 250 μA	2.5		5.0 V
I _{GSS}	V _{GS} = ±20 V _{DC} , V _{DS} = 0			±100 nA
I _{DSS}	V _{DS} = V _{DSS} V _{GS} = 0 V T _J = 125° C			25 μA
				250 μA
R _{DS(on)}	V _{GS} = 10 V, I _D = 0.5 I _{D25} Pulse test, t ≤ 300 μs, duty cycle d ≤ 2 %			27 mΩ

Symbol	Test Conditions	Characteristic Values ($T_J = 25^\circ\text{C}$, unless otherwise specified)		
		Min.	Typ.	Max.
g_{fs}	$V_{DS} = 10\text{ V}; I_D = 0.5 I_{D25}$, pulse test	40	56	S
C_{iss}	$V_{GS} = 0\text{ V}, V_{DS} = 25\text{ V}, f = 1\text{ MHz}$		6300	pF
C_{oss}			1150	pF
C_{rss}			240	pF
$t_{d(on)}$	$V_{GS} = 10\text{ V}, V_{DS} = 0.5 V_{DSS}, I_D = I_{D25}$ $R_G = 3.3\ \Omega$ (External)		25	ns
t_r			26	ns
$t_{d(off)}$			100	ns
t_f			28	ns
$Q_{g(on)}$	$V_{GS} = 10\text{ V}, V_{DS} = 0.5 V_{DSS}, I_D = 0.5 I_{D25}$		185	nC
Q_{gs}			43	nC
Q_{gd}			91	nC
R_{thJC}				0.21°C/W
R_{thCS}	TO-3P		0.21	$^\circ\text{C/W}$
R_{thCS}	TO-264		0.15	$^\circ\text{C/W}$

Symbol	Test Conditions	Characteristic Values ($T_J = 25^\circ\text{C}$, unless otherwise specified)		
		Min.	Typ.	Max.
I_S	$V_{GS} = 0\text{ V}$			100 A
I_{SM}	Repetitive			250 A
V_{SD}	$I_F = I_S, V_{GS} = 0\text{ V}$, Pulse test, $t \leq 300\ \mu\text{s}$, duty cycle $d \leq 2\%$			1.5 V
t_{rr}	$I_F = 25\text{ A}, -di/dt = 100\text{ A}/\mu\text{s}$ $V_R = 100\text{ V}, V_{GS} = 0\text{ V}$		200	ns
Q_{RM}			3.0	μC

TO-268 (IXTT) Outline

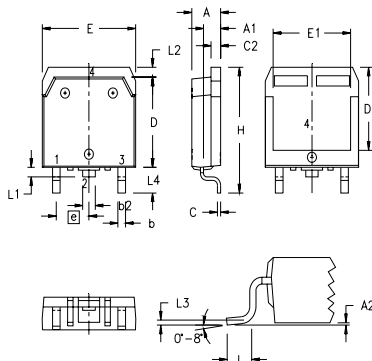

SYM	INCHES		MILLIMETERS	
	MIN	MAX	MIN	MAX
A	.193	.201	4.90	5.10
A1	.106	.114	2.70	2.90
A2	.001	.010	0.02	0.25
b	.045	.057	1.15	1.45
b2	.075	.083	1.90	2.10
C	.016	.026	0.40	0.65
C2	.057	.063	1.45	1.60
D	.543	.551	13.80	14.00
D1	.488	.500	12.40	12.70
E	.624	.632	15.85	16.05
E1	.524	.535	13.30	13.60
e	.215 BSC		5.45 BSC	
H	.736	.752	18.70	19.10
L	.094	.106	2.40	2.70
L1	.047	.055	1.20	1.40
L2	.039	.045	1.00	1.15
L3	.010 BSC		0.25 BSC	
L4	.150	.161	3.80	4.10

TO-3P (IXTQ) Outline

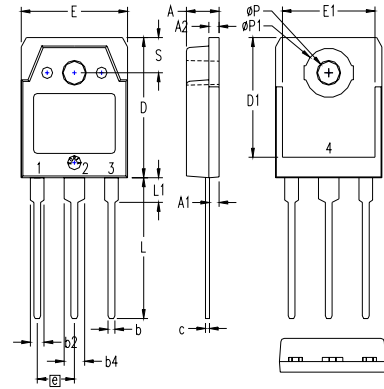

- 1 - GATE
- 2 - DRAIN (COLLECTOR)
- 3 - SOURCE (EMITTER)
- 4 - DRAIN (COLLECTOR)

SYM	INCHES		MILLIMETERS	
	MIN	MAX	MIN	MAX
A	.185	.193	4.70	4.90
A1	.051	.059	1.30	1.50
A2	.057	.065	1.45	1.65
b	.035	.045	0.90	1.15
b2	.075	.087	1.90	2.20
b4	.114	.126	2.90	3.20
c	.022	.031	0.55	0.80
D	.780	.799	19.80	20.30
D1	.665	.677	16.90	17.20
E	.610	.622	15.50	15.80
E1	.531	.539	13.50	13.70
e	.215 BSC		5.45 BSC	
L	.779	.795	19.80	20.20
L1	.134	.142	3.40	3.60
ØP	.126	.134	3.20	3.40
ØP1	.272	.280	6.90	7.10
S	.193	.201	4.90	5.10

TO-264 (IXTK) Outline

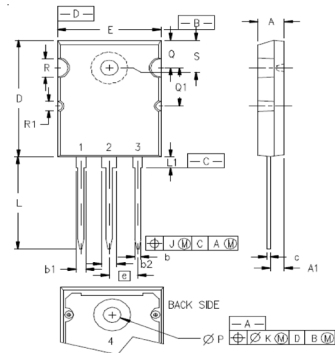

- 1 - GATE
- 2, 4 - DRAIN (COLLECTOR)
- 3 - SOURCE (EMITTER)

SYM	INCHES		MILLIMETERS	
	MIN	MAX	MIN	MAX
A	.185	.209	4.70	5.31
A1	.102	.118	2.59	3.00
b	.037	.055	0.94	1.40
b1	.087	.102	2.21	2.59
b2	.110	.126	2.79	3.20
c	.017	.029	0.43	0.74
D	1.007	1.047	25.58	26.59
E	.760	.799	19.30	20.29
e	.215 BSC		5.46 BSC	
J	.000	.010	0.00	0.25
K	.000	.010	0.00	0.25
L	.779	.842	19.79	21.39
L1	.087	.102	2.21	2.59
ØP	.122	.138	3.10	3.51
Q	.240	.256	6.10	6.50
Q1	.330	.346	8.38	8.79
ØR	.155	.187	3.94	4.75
ØR1	.085	.093	2.16	2.36
S	.243	.253	6.17	6.43

IXYS reserves the right to change limits, test conditions, and dimensions.

IXYS MOSFETs and IGBTs are covered by 4,835,592 4,931,844 5,049,961 5,237,481 6,162,665 6,404,065 B1 6,683,344 6,727,585
 one or more of the following U.S. patents: 4,850,072 5,017,508 5,063,307 5,381,025 6,259,123 B1 6,534,343 6,710,405 B2 6,759,692
 4,881,106 5,034,796 5,187,117 5,486,715 6,306,728 B1 6,583,505 6,710,463 6,771,478 B2

**Fig. 1. Output Characteristics
@ 25°C**

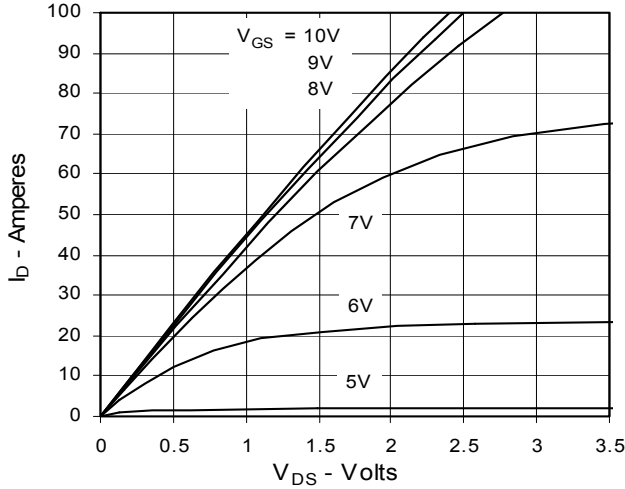

**Fig. 2. Extended Output Characteristics
@ 25°C**

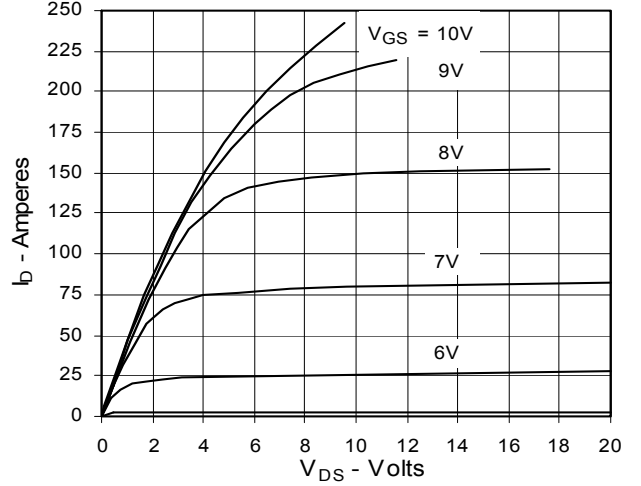

**Fig. 3. Output Characteristics
@ 125°C**

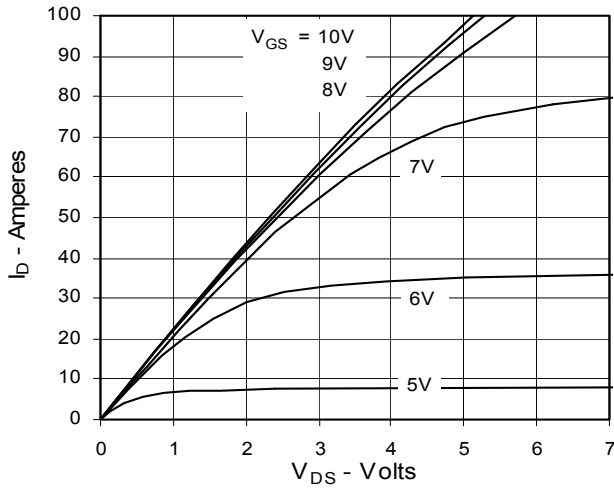

**Fig. 4. $R_{DS(on)}$ Normalized to 0.5 I_{D25}
Value vs. Junction Temperature**

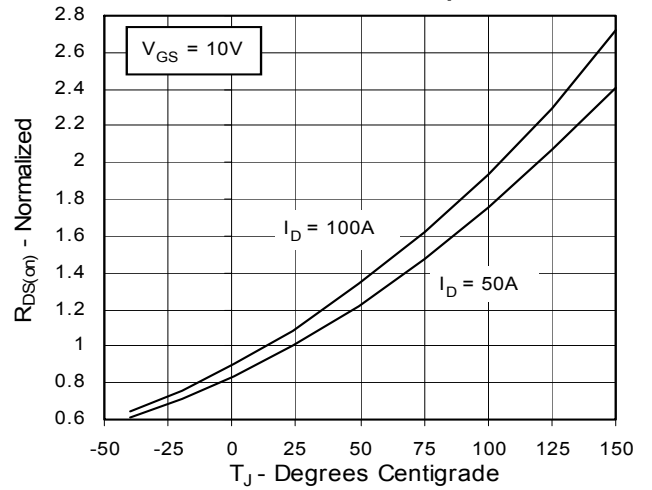

**Fig. 5. $R_{DS(on)}$ Normalized to
0.5 I_{D25} Value vs. I_D**

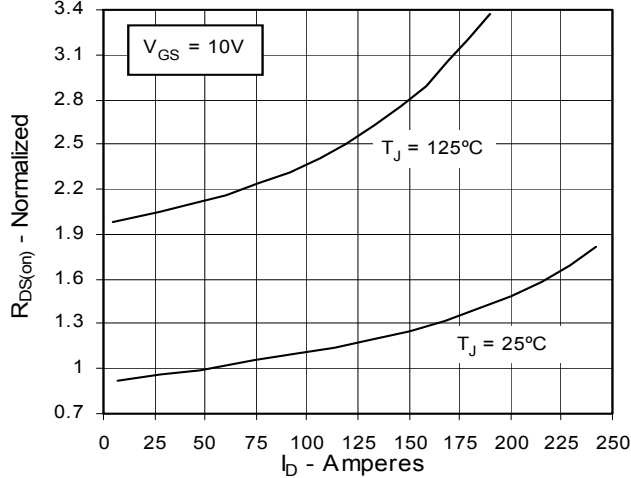

**Fig. 6. Drain Current vs. Case
Temperature**

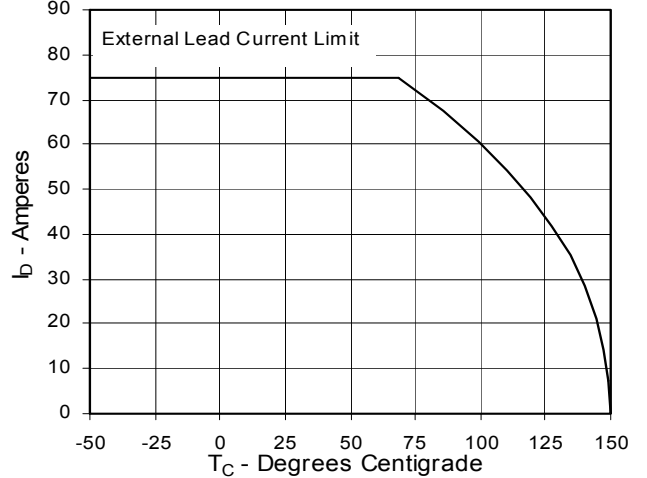

Fig. 7. Input Admittance

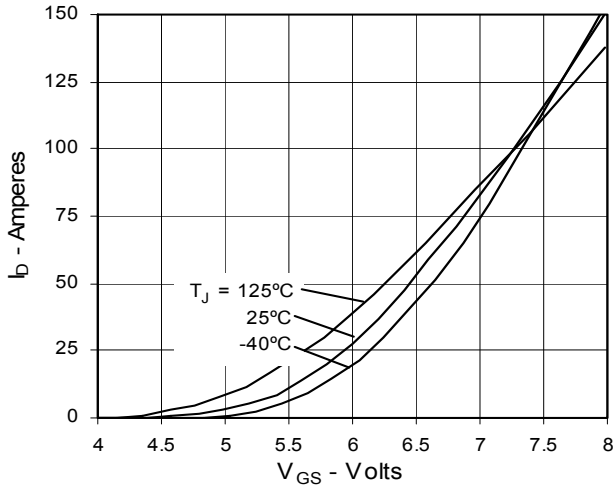

Fig. 8. Transconductance

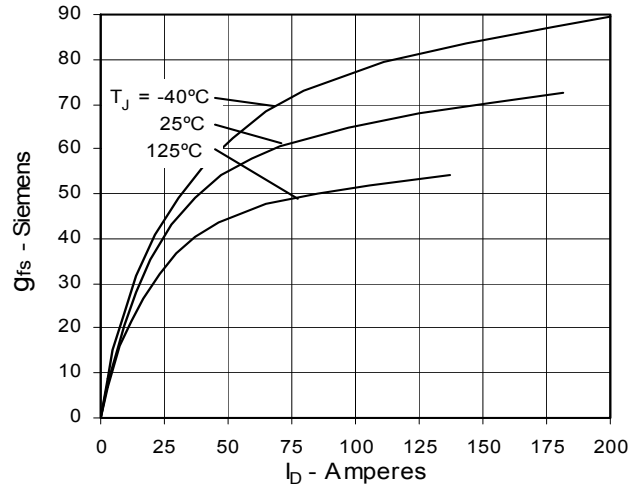

Fig. 9. Source Current vs. Source-To-Drain Voltage

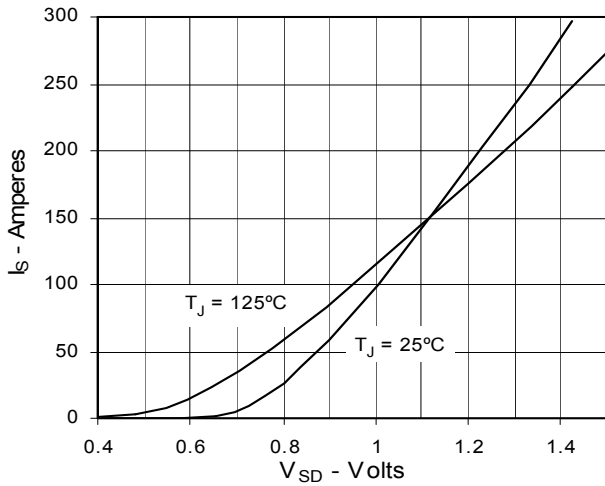

Fig. 10. Gate Charge

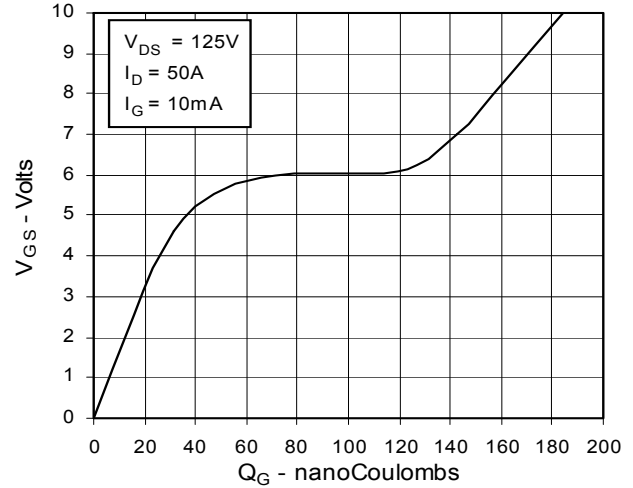

Fig. 11. Capacitance

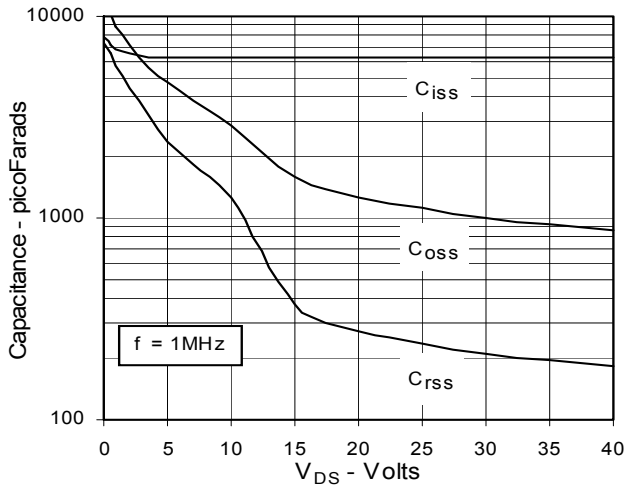

Fig. 12. Forward-Bias Safe Operating Area

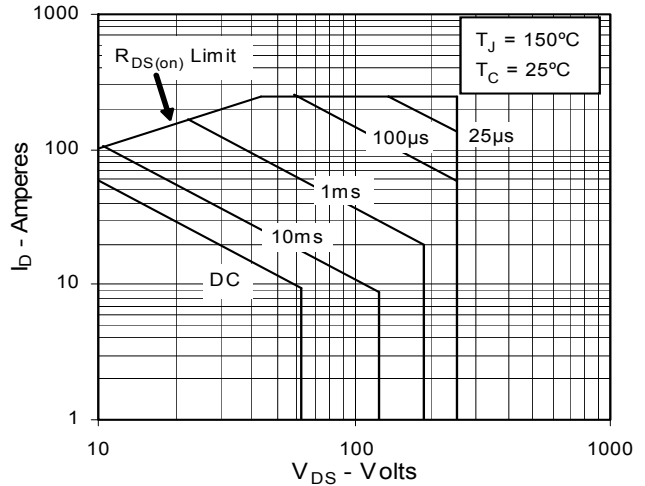
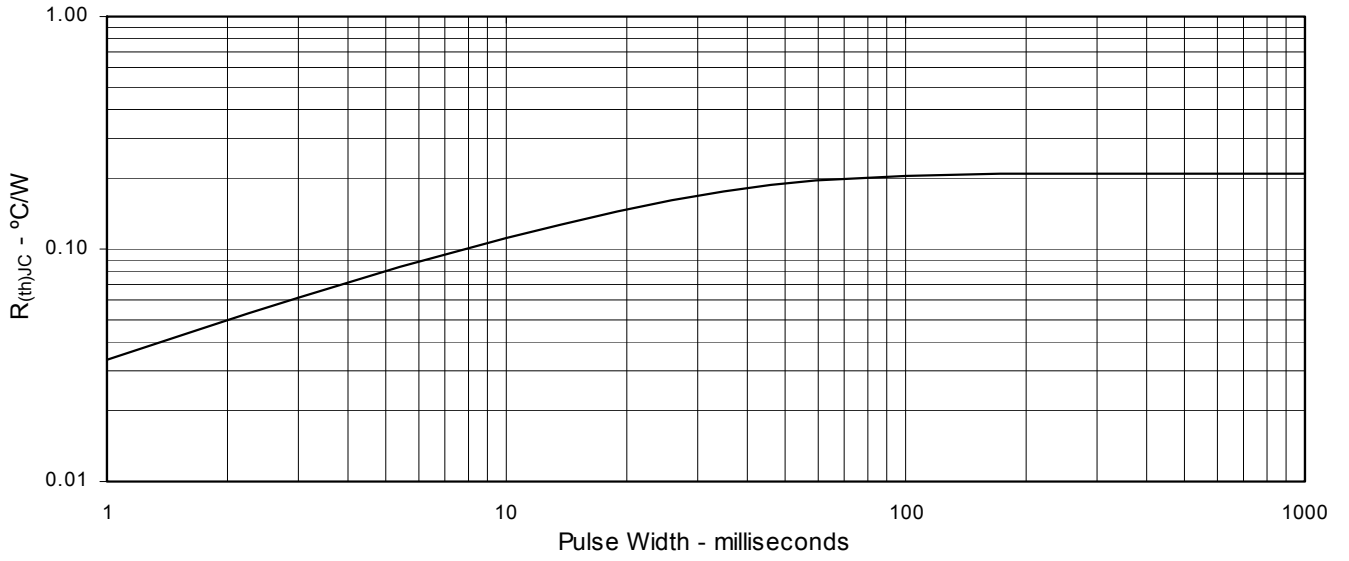

Fig. 13. Maximum Transient Thermal Resistance





Disclaimer Notice - Information furnished is believed to be accurate and reliable. However, users should independently evaluate the suitability of and test each product selected for their own applications. Littelfuse products are not designed for, and may not be used in, all applications. Read complete Disclaimer Notice at www.littelfuse.com/disclaimer-electronics.