

LinearL2™
Power MOSFET
w/ Extended FBSOA

IXTK90N25L2
IXTX90N25L2

V_{DSS} = 250V
I_{D25} = 90A
R_{DS(on)} ≤ 36mΩ

N-Channel Enhancement Mode
 Avalanche Rated



| Symbol | Test Conditions | Maximum Ratings | |
|-------------------|---|------------------|----------|
| V _{DSS} | T _J = 25°C to 150°C | 250 | V |
| V _{DGR} | T _J = 25°C to 150°C, R _{GS} = 1MΩ | 250 | V |
| V _{GSS} | Continuous | ±20 | V |
| V _{GSM} | Transient | ±30 | V |
| I _{D25} | T _C = 25°C | 90 | A |
| I _{DM} | T _C = 25°C, Pulse Width Limited by T _{JM} | 360 | A |
| I _A | T _C = 25°C | 45 | A |
| E _{AS} | T _C = 25°C | 3 | J |
| P _D | T _C = 25°C | 960 | W |
| T _J | | -55...+150 | °C |
| T _{JM} | | 150 | °C |
| T _{stg} | | -55...+150 | °C |
| T _L | Maximum Lead Temperature for Soldering | 300 | °C |
| T _{SOLD} | 1.6 mm (0.062in.) from Case for 10s | 260 | °C |
| M _d | Mounting Torque (TO-264) | 1.13/10 | Nm/lb.in |
| F _C | Mounting Force (PLUS247) | 20..120 /4.5..27 | N/lb |
| Weight | TO-264 | 10 | g |
| | PLUS247 | 6 | g |

TO-264 (IXTK)

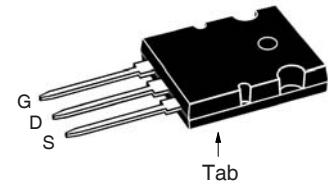

PLUS247 (IXTX)

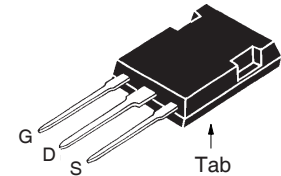

G = Gate D = Drain
 S = Source Tab = Drain

Features

- Designed for Linear Operation
- International Standard Packages
- Avalanche Rated
- Guaranteed FBSOA at 75°C

Advantages

- Easy to Mount
- Space Savings
- High Power Density

Applications

- Solid State Circuit Breakers
- Soft Start Controls
- Linear Amplifiers
- Programmable Loads
- Current Regulators

| Symbol | Test Conditions (T _J = 25°C, Unless Otherwise Specified) | Characteristic Values | | |
|---------------------|---|-----------------------|------|-----------------|
| | | Min. | Typ. | Max. |
| BV _{DSS} | V _{GS} = 0V, I _D = 1mA | 250 | | V |
| V _{GS(th)} | V _{DS} = V _{GS} , I _D = 3mA | 2.0 | | V |
| I _{GSS} | V _{GS} = ±20V, V _{DS} = 0V | | | ±200 nA |
| I _{DSS} | V _{DS} = V _{DSS} , V _{GS} = 0V T _J = 125°C | | | 50 μA 2.5 mA |
| R _{DS(on)} | V _{GS} = 10V, I _D = 0.5 • I _{D25} , Note 1 | | | 36 mΩ |

| Symbol | Test Conditions ($T_J = 25^\circ\text{C}$, Unless Otherwise Specified) | Characteristic Values | | | |
|--------------|--|-----------------------|------|------|--------------------|
| | | Min. | Typ. | Max. | |
| g_{fs} | $V_{DS} = 10\text{V}$, $I_D = 0.5 \cdot I_{D25}$, Note 1 | 35 | 50 | 65 | S |
| C_{iss} | $V_{GS} = 0\text{V}$, $V_{DS} = 25\text{V}$, $f = 1\text{MHz}$ | | 23 | | nF |
| C_{oss} | | | 2140 | | pF |
| C_{rss} | | | 360 | | pF |
| $t_{d(on)}$ | Resistive Switching Times $V_{GS} = 10\text{V}$, $V_{DS} = 0.5 \cdot V_{DSS}$, $I_D = 0.5 \cdot I_{D25}$ $R_G = 1\Omega$ (External) | | 50 | | ns |
| t_r | | | 175 | | ns |
| $t_{d(off)}$ | | | 40 | | ns |
| t_f | | | 160 | | ns |
| $Q_{g(on)}$ | $V_{GS} = 10\text{V}$, $V_{DS} = 0.5 \cdot V_{DSS}$, $I_D = 0.5 \cdot I_{D25}$ | | 640 | | nC |
| Q_{gs} | | | 125 | | nC |
| Q_{gd} | | | 385 | | nC |
| R_{thJC} | | | | 0.13 | $^\circ\text{C/W}$ |
| R_{thCS} | | 0.15 | | | $^\circ\text{C/W}$ |

Safe Operating Area Specification

| Symbol | Test Conditions | Characteristic Values | | |
|--------|---|-----------------------|------|------|
| | | Min. | Typ. | Max. |
| SOA | $V_{DS} = 250\text{V}$, $I_D = 2.3\text{A}$, $T_C = 75^\circ\text{C}$, $T_p = 5\text{s}$ | 575 | | W |

Source-Drain Diode

| Symbol | Test Conditions ($T_J = 25^\circ\text{C}$, Unless Otherwise Specified) | Characteristic Values | | | |
|----------|--|-----------------------|------|------|---------------|
| | | Min. | Typ. | Max. | |
| I_S | $V_{GS} = 0\text{V}$ | | | 90 | A |
| I_{SM} | Repetitive, Pulse Width Limited by T_{JM} | | | 360 | A |
| V_{SD} | $I_F = 45\text{A}$, $V_{GS} = 0\text{V}$, Note 1 | | | 1.5 | V |
| t_{rr} | $I_F = 45\text{A}$, $-di/dt = 100\text{A}/\mu\text{s}$, $V_R = 80\text{V}$, $V_{GS} = 0\text{V}$ | | 266 | | ns |
| I_{RM} | | | 23 | | A |
| Q_{RM} | | | 3.0 | | μC |

Note: 1. Pulse test, $t \leq 300\mu\text{s}$, duty cycle, $d \leq 2\%$.

IXYS Reserves the Right to Change Limits, Test Conditions, and Dimensions.

IXYS MOSFETs and IGBTs are covered by one or more of the following U.S. patents:

| | | | | | | | | | |
|-----------|-----------|-----------|-----------|--------------|--------------|--------------|--------------|--------------|-------------|
| 4,835,592 | 4,931,844 | 5,049,961 | 5,237,481 | 6,162,665 | 6,404,065 B1 | 6,683,344 | 6,727,585 | 7,005,734 B2 | 7,157,338B2 |
| 4,860,072 | 5,017,508 | 5,063,307 | 5,381,025 | 6,259,123 B1 | 6,534,343 | 6,710,405 B2 | 6,759,692 | 7,063,975 B2 | |
| 4,881,106 | 5,034,796 | 5,187,117 | 5,486,715 | 6,306,728 B1 | 6,583,505 | 6,710,463 | 6,771,478 B2 | 7,071,537 | |

TO-264 AA Outline

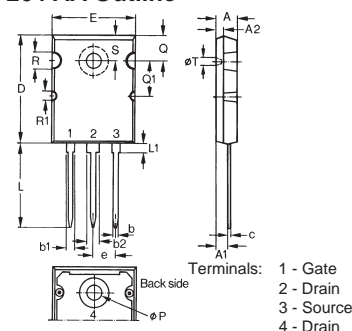

| Dim. | Millimeter | | Inches | |
|------|------------|-------|----------|-------|
| | Min. | Max. | Min. | Max. |
| A | 4.82 | 5.13 | .190 | .202 |
| A1 | 2.54 | 2.89 | .100 | .114 |
| A2 | 2.00 | 2.10 | .079 | .083 |
| b | 1.12 | 1.42 | .044 | .056 |
| b1 | 2.39 | 2.69 | .094 | .106 |
| b2 | 2.90 | 3.09 | .114 | .122 |
| c | 0.53 | 0.83 | .021 | .033 |
| D | 25.91 | 26.16 | 1.020 | 1.030 |
| E | 19.81 | 19.96 | .780 | .786 |
| e | 5.46 BSC | | .215 BSC | |
| J | 0.00 | 0.25 | .000 | .010 |
| K | 0.00 | 0.25 | .000 | .010 |
| L | 20.32 | 20.83 | .800 | .820 |
| L1 | 2.29 | 2.59 | .090 | .102 |
| P | 3.17 | 3.66 | .125 | .144 |
| Q | 6.07 | 6.27 | .239 | .247 |
| Q1 | 8.38 | 8.69 | .330 | .342 |
| R | 3.81 | 4.32 | .150 | .170 |
| R1 | 1.78 | 2.29 | .070 | .090 |
| S | 6.04 | 6.30 | .238 | .248 |
| T | 1.57 | 1.83 | .062 | .072 |

PLUS 247™ Outline

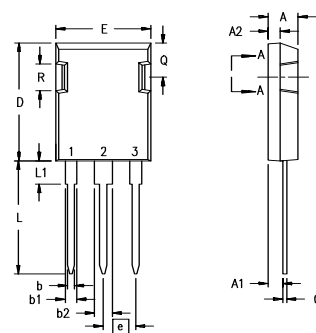

Terminals: 1 - Gate
2 - Drain
3 - Source

| Dim. | Millimeter | | Inches | |
|------|------------|-------|----------|-------|
| | Min. | Max. | Min. | Max. |
| A | 4.83 | 5.21 | .190 | .205 |
| A1 | 2.29 | 2.54 | .090 | .100 |
| A2 | 1.91 | 2.16 | .075 | .085 |
| b | 1.14 | 1.40 | .045 | .055 |
| b1 | 1.91 | 2.13 | .075 | .084 |
| b2 | 2.92 | 3.12 | .115 | .123 |
| C | 0.61 | 0.80 | .024 | .031 |
| D | 20.80 | 21.34 | .819 | .840 |
| E | 15.75 | 16.13 | .620 | .635 |
| e | 5.45 BSC | | .215 BSC | |
| L | 19.81 | 20.32 | .780 | .800 |
| L1 | 3.81 | 4.32 | .150 | .170 |
| Q | 5.59 | 6.20 | .220 | 0.244 |
| R | 4.32 | 4.83 | .170 | .190 |

Fig. 1. Output Characteristics @ $T_J = 25^\circ\text{C}$

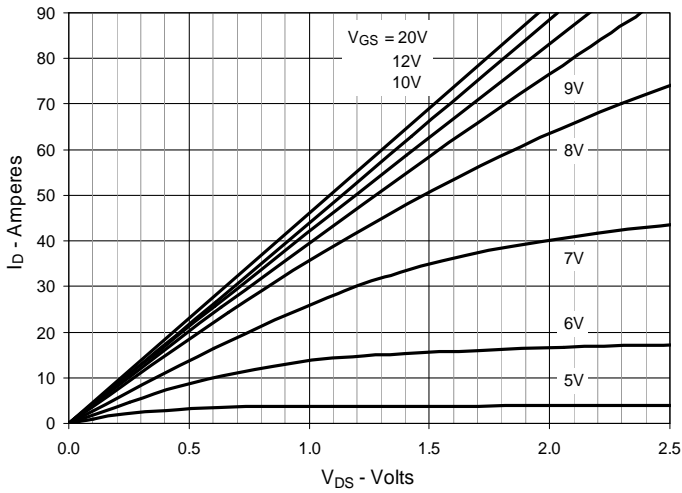

Fig. 2. Extended Output Characteristics @ $T_J = 25^\circ\text{C}$

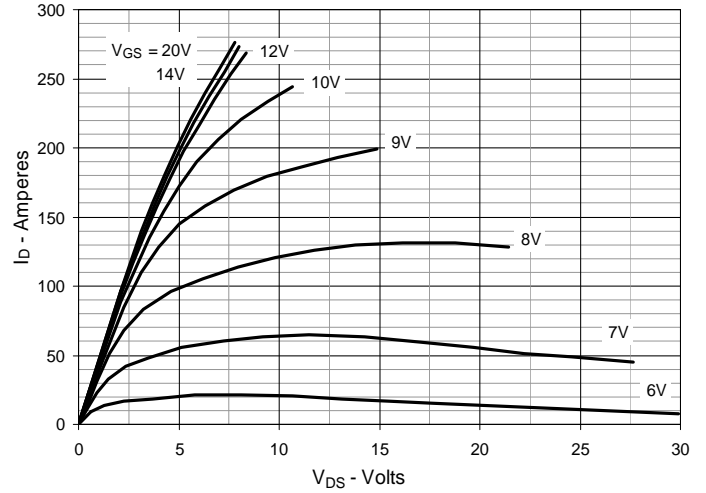

Fig. 3. Output Characteristics @ $T_J = 125^\circ\text{C}$

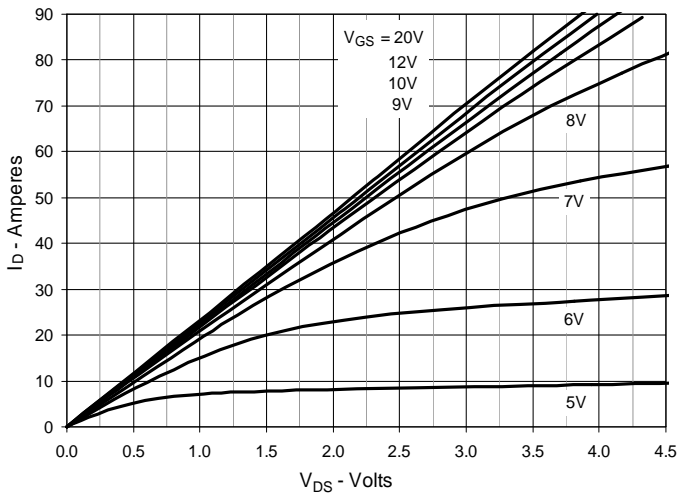

Fig. 4. $R_{DS(on)}$ Normalized to $I_D = 45\text{A}$ Value vs. Junction Temperature

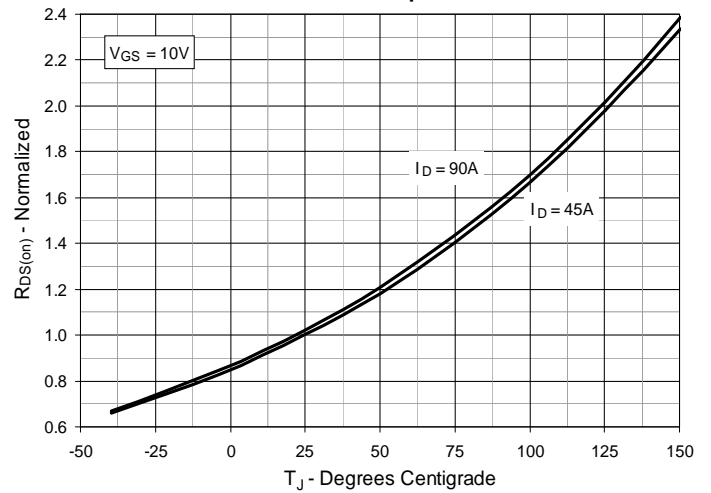

Fig. 5. $R_{DS(on)}$ Normalized to $I_D = 45\text{A}$ Value vs. Drain Current

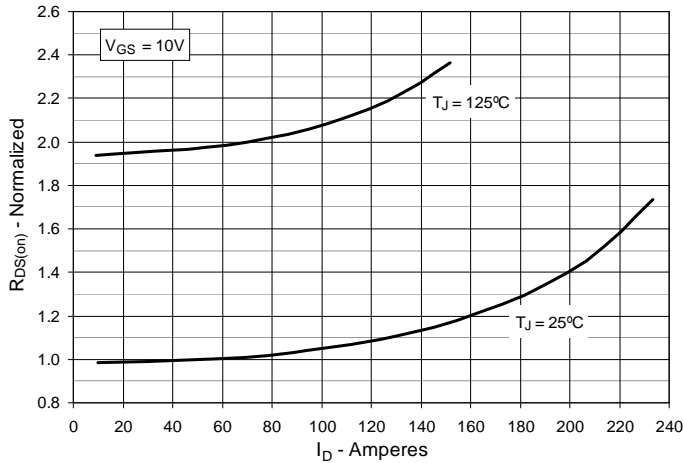

Fig. 6. Maximum Drain Current vs. Case Temperature

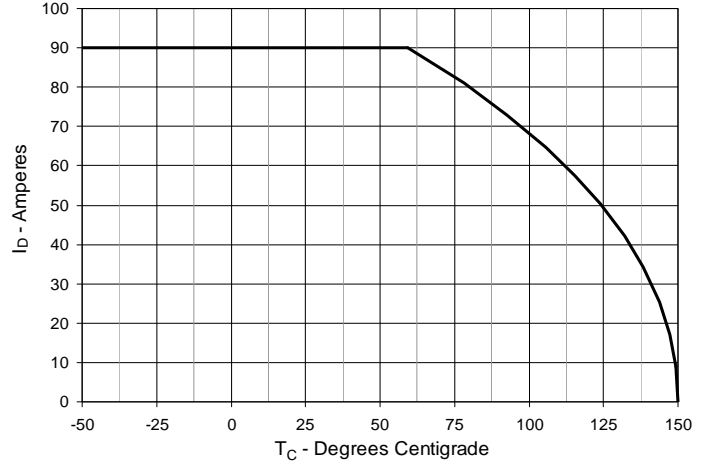

Fig. 7. Input Admittance

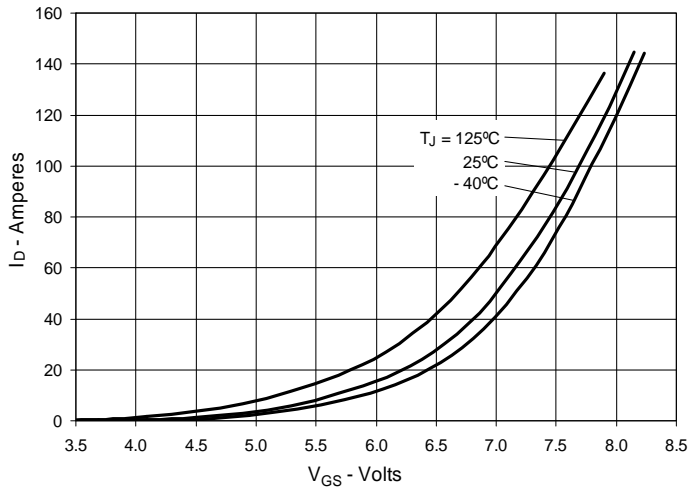

Fig. 8. Transconductance

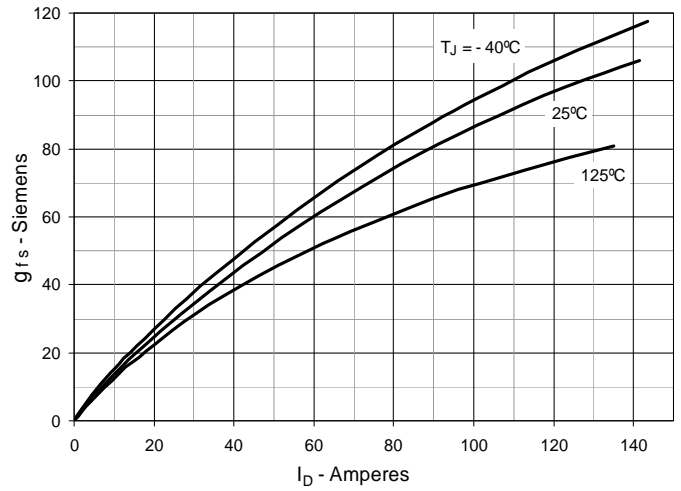

Fig. 9. Forward Voltage Drop of Intrinsic Diode

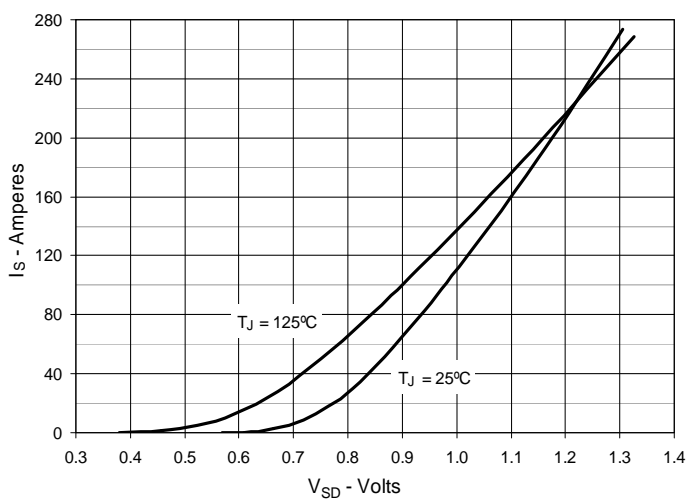

Fig. 10. Gate Charge

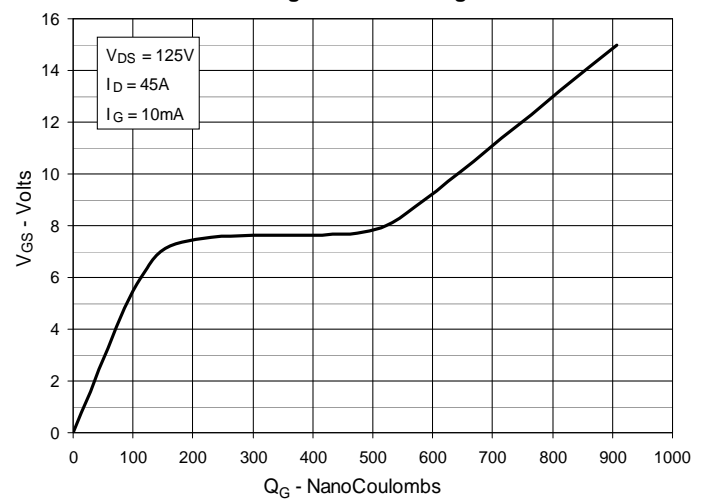

Fig. 11. Capacitance

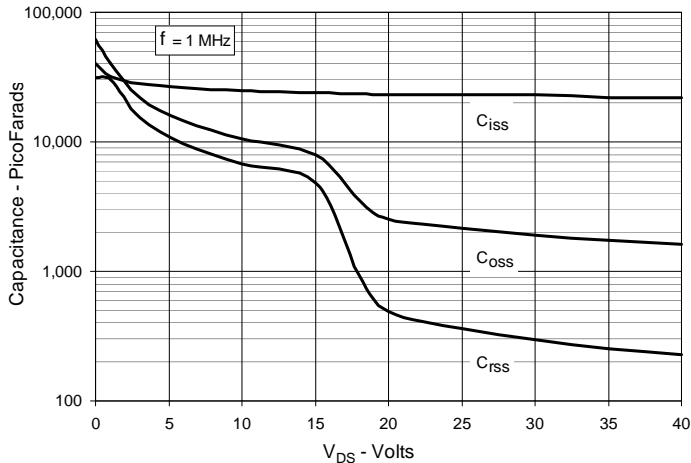

Fig. 12. Maximum Transient Thermal Impedance

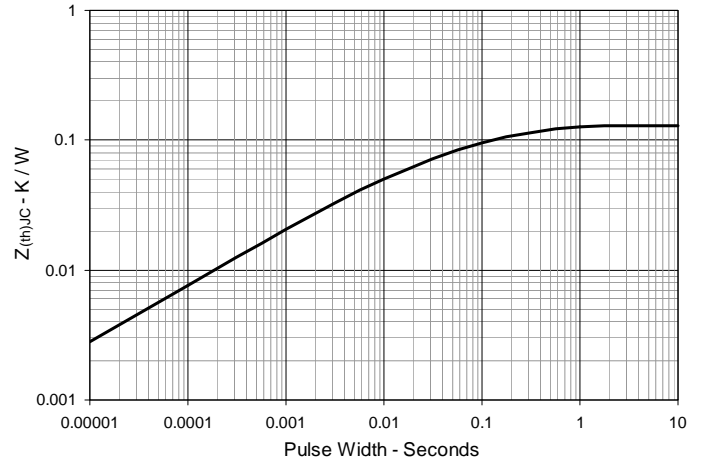

Fig. 13. Forward-Bias Safe Operating Area
@ $T_C = 25^\circ\text{C}$

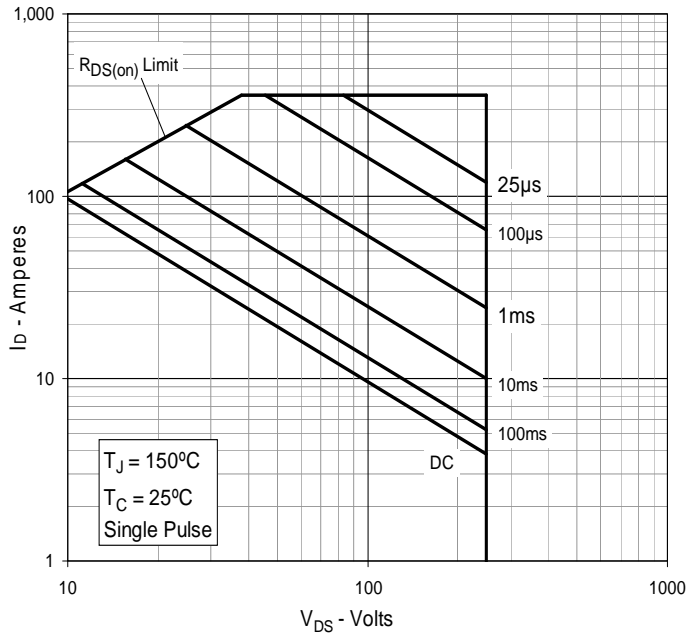
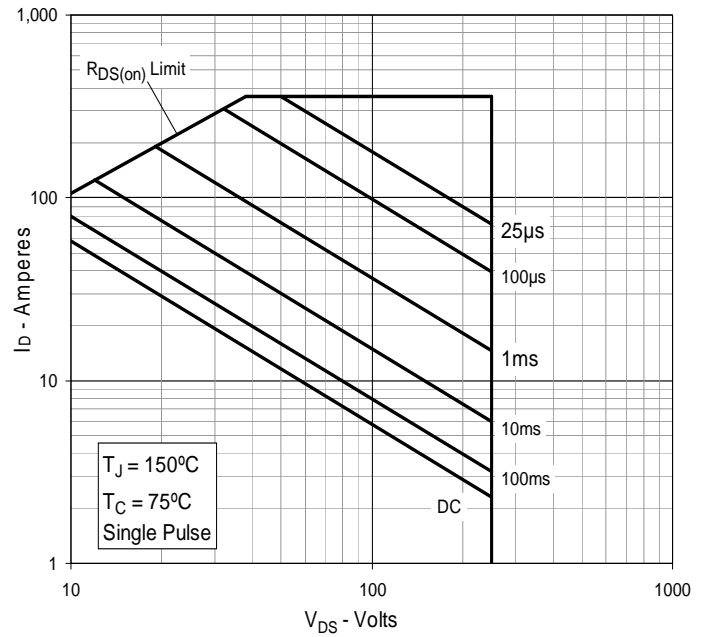

Fig. 14. Forward-Bias Safe Operating Area
@ $T_C = 75^\circ\text{C}$





Disclaimer Notice - Information furnished is believed to be accurate and reliable. However, users should independently evaluate the suitability of and test each product selected for their own applications. Littelfuse products are not designed for, and may not be used in, all applications. Read complete Disclaimer Notice at www.littelfuse.com/disclaimer-electronics.