

**Polar™ HiPerFET™  
Power MOSFETs**

**IXFK40N90P  
IXFX40N90P**

N-Channel Enhancement Mode  
Avalanche Rated  
Fast Intrinsic Rectifier

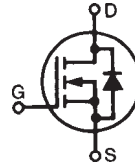

$V_{DSS} = 900V$   
 $I_{D25} = 40A$   
 $R_{DS(on)} \leq 230m\Omega$   
 $t_{rr} \leq 300ns$

| Symbol        | Test Conditions  | Maximum Ratings   |            |
|---------------|--|-------------------|------------|
| $V_{DSS}$     | $T_J = 25^\circ C$ to $150^\circ C$                                | 900               | V          |
| $V_{DGR}$     | $T_J = 25^\circ C$ to $150^\circ C$ , $R_{GS} = 1M\Omega$          | 900               | V          |
| $V_{GSS}$     | Continuous   | $\pm 30$          | V          |
| $V_{GSM}$     | Transient  | $\pm 40$          | V          |
| $I_{D25}$     | $T_C = 25^\circ C$   | 40                | A          |
| $I_{DM}$      | $T_C = 25^\circ C$ , Pulse Width Limited by $T_{JM}$               | 80                | A          |
| $I_A$         | $T_C = 25^\circ C$   | 20                | A          |
| $E_{AS}$      | $T_C = 25^\circ C$   | 2.5               | J          |
| $dv/dt$       | $I_S \leq I_{DM}$ , $V_{DD} \leq V_{DSS}$ , $T_J \leq 150^\circ C$ | 15                | V/ns       |
| $P_D$         | $T_C = 25^\circ C$   | 960               | W          |
| $T_J$         |  | -55 to +150       | $^\circ C$ |
| $T_{JM}$      |  | 150               | $^\circ C$ |
| $T_{stg}$     |  | -55 to +150       | $^\circ C$ |
| $T_L$         | 1.6mm (0.062 in.) from Case for 10s                                | 300               | $^\circ C$ |
| $T_{SOLD}$    | Plastic Body for 10s   | 260               | $^\circ C$ |
| $M_d$         | Mounting Torque (TO-264)   | 1.13/10           | Nm/lb.in.  |
| $F_C$         | Mounting Force (PLUS247)   | 20..120 / 4.5..27 | N/lb.      |
| <b>Weight</b> | TO-264   | 10                | g          |
|               | PLUS247  | 6                 | g          |

TO-264 (IXFK)

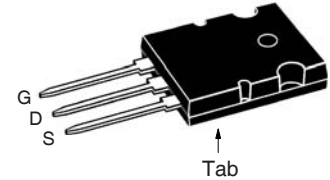

PLUS247 (IXFX)

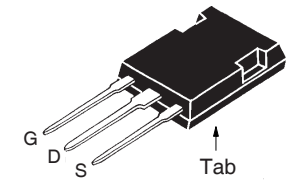

G = Gate      D = Drain  
S = Source      Tab = Drain

**Features**

- Low  $R_{DS(on)}$  and  $Q_G$
- Avalanche Rated
- Low Package Inductance
- Fast Intrinsic Rectifier

**Advantages**

- High Power Density
- Easy to Mount
- Space Savings

**Applications**

- Switch-Mode and Resonant-Mode Power Supplies
- DC-DC Converters
- Laser Drivers
- AC and DC Motor Drives
- Robotics and Servo Controls

| Symbol       | Test Conditions<br>( $T_J = 25^\circ C$ , Unless Otherwise Specified) | Characteristic Values |      |                      |
|--------------|---|-----------------------|------|----------------------|
|              |   | Min.                  | Typ. | Max.                 |
| $BV_{DSS}$   | $V_{GS} = 0V$ , $I_D = 3mA$   | 900                   |      | V                    |
| $V_{GS(th)}$ | $V_{DS} = V_{GS}$ , $I_D = 1mA$                                       | 3.5                   |      | 6.5 V                |
| $I_{GSS}$    | $V_{GS} = \pm 30V$ , $V_{DS} = 0V$                                    |                       |      | $\pm 200$ nA         |
| $I_{DSS}$    | $V_{DS} = V_{DSS}$ , $V_{GS} = 0V$<br>$T_J = 125^\circ C$             |                       |      | 50 $\mu A$<br>3.5 mA |
| $R_{DS(on)}$ | $V_{GS} = 10V$ , $I_D = 0.5 \cdot I_{D25}$ , Note 1                   |                       |      | 230 m $\Omega$       |

| Symbol       | Test Conditions<br>( $T_J = 25^\circ\text{C}$ , Unless Otherwise Specified)  | Characteristic Values |      |                    |
|--------------|--|-----------------------|------|--------------------|
|              |  | Min.                  | Typ. | Max.               |
| $g_{fs}$     | $V_{DS} = 20\text{V}$ , $I_D = 0.5 \cdot I_{D25}$ , Note 1   | 18                    | 30   | S                  |
| $C_{iss}$    | $V_{GS} = 0\text{V}$ , $V_{DS} = 25\text{V}$ , $f = 1\text{MHz}$   |                       | 14   | nF                 |
| $C_{oss}$    |  |                       | 896  | pF                 |
| $C_{rss}$    |  |                       | 58   | pF                 |
| $R_{Gi}$     | Gate Input Resistance  |                       | 1.5  | $\Omega$           |
| $t_{d(on)}$  | <b>Resistive Switching Times</b><br>$V_{GS} = 10\text{V}$ , $V_{DS} = 0.5 \cdot V_{DSS}$ , $I_D = 0.5 \cdot I_{D25}$<br>$R_G = 1\Omega$ (External) |                       | 53   | ns                 |
| $t_r$        |  |                       | 50   | ns                 |
| $t_{d(off)}$ |  |                       | 77   | ns                 |
| $t_f$        |  |                       | 46   | ns                 |
| $Q_{g(on)}$  | $V_{GS} = 10\text{V}$ , $V_{DS} = 0.5 \cdot V_{DSS}$ , $I_D = 0.5 \cdot I_{D25}$   |                       | 230  | nC                 |
| $Q_{gs}$     |  |                       | 70   | nC                 |
| $Q_{gd}$     |  |                       | 100  | nC                 |
| $R_{thJC}$   |  |                       | 0.13 | $^\circ\text{C/W}$ |
| $R_{thCS}$   |  | 0.15                  |      | $^\circ\text{C/W}$ |

### Source-Drain Diode

| Symbol   | Test Conditions<br>( $T_J = 25^\circ\text{C}$ , Unless Otherwise Specified)                             | Characteristic Values |      |               |
|----------|---|-----------------------|------|---------------|
|          |   | Min.                  | Typ. | Max.          |
| $I_S$    | $V_{GS} = 0\text{V}$  |                       |      | 40 A          |
| $I_{SM}$ | Repetitive, Pulse Width Limited by $T_{JM}$   |                       |      | 160 A         |
| $V_{SD}$ | $I_F = I_S$ , $V_{GS} = 0\text{V}$ , Note 1   |                       |      | 1.5 V         |
| $t_{rr}$ | $I_F = 20\text{A}$ , $-di/dt = 100\text{A}/\mu\text{s}$ ,<br>$V_R = 100\text{V}$ , $V_{GS} = 0\text{V}$ |                       | 14.0 | ns            |
| $I_{RM}$ |   |                       | 1.7  | A             |
| $Q_{RM}$ |   |                       |      | $\mu\text{C}$ |

Note: 1. Pulse test,  $t \leq 300\mu\text{s}$ , duty cycle,  $d \leq 2\%$ .

### TO-264 Outline

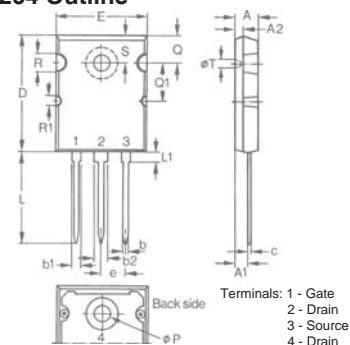

| Dim. | Millimeter |       | Inches   |       |
|------|------------|-------|----------|-------|
|      | Min.       | Max.  | Min.     | Max.  |
| A    | 4.82       | 5.13  | .190     | .202  |
| A1   | 2.54       | 2.89  | .100     | .114  |
| A2   | 2.00       | 2.10  | .079     | .083  |
| b    | 1.12       | 1.42  | .044     | .056  |
| b1   | 2.39       | 2.69  | .094     | .106  |
| b2   | 2.90       | 3.09  | .114     | .122  |
| c    | 0.53       | 0.83  | .021     | .033  |
| D    | 25.91      | 26.16 | 1.020    | 1.030 |
| E    | 19.81      | 19.96 | .780     | .786  |
| e    | 5.46 BSC   |       | .215 BSC |       |
| J    | 0.00       | 0.25  | .000     | .010  |
| K    | 0.00       | 0.25  | .000     | .010  |
| L    | 20.32      | 20.83 | .800     | .820  |
| L1   | 2.29       | 2.59  | .090     | .102  |
| P    | 3.17       | 3.66  | .125     | .144  |
| Q    | 6.07       | 6.27  | .239     | .247  |
| Q1   | 8.38       | 8.69  | .330     | .342  |
| R    | 3.81       | 4.32  | .150     | .170  |
| R1   | 1.78       | 2.29  | .070     | .090  |
| S    | 6.04       | 6.30  | .238     | .248  |
| T    | 1.57       | 1.83  | .062     | .072  |

### PLUS247™ Outline

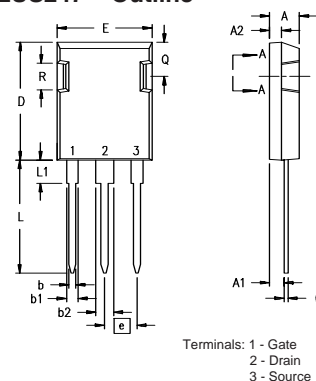

| Dim.           | Millimeter |       | Inches   |       |
|----------------|------------|-------|----------|-------|
|                | Min.       | Max.  | Min.     | Max.  |
| A              | 4.83       | 5.21  | .190     | .205  |
| A <sub>1</sub> | 2.29       | 2.54  | .090     | .100  |
| A <sub>2</sub> | 1.91       | 2.16  | .075     | .085  |
| b              | 1.14       | 1.40  | .045     | .055  |
| b <sub>1</sub> | 1.91       | 2.13  | .075     | .084  |
| b <sub>2</sub> | 2.92       | 3.12  | .115     | .123  |
| C              | 0.61       | 0.80  | .024     | .031  |
| D              | 20.80      | 21.34 | .819     | .840  |
| E              | 15.75      | 16.13 | .620     | .635  |
| e              | 5.45 BSC   |       | .215 BSC |       |
| L              | 19.81      | 20.32 | .780     | .800  |
| L1             | 3.81       | 4.32  | .150     | .170  |
| Q              | 5.59       | 6.20  | .220     | 0.244 |
| R              | 4.32       | 4.83  | .170     | .190  |

IXYS Reserves the Right to Change Limits, Test Conditions, and Dimensions.

|  |           |           |           |           |              |              |              |              |              |             |
|--|-----------|-----------|-----------|-----------|--------------|--------------|--------------|--------------|--------------|-------------|
| IXYS MOSFETs and IGBTs are covered by one or more of the following U.S. patents: | 4,835,592 | 4,931,844 | 5,049,961 | 5,237,481 | 6,162,665    | 6,404,065 B1 | 6,683,344    | 6,727,585    | 7,005,734 B2 | 7,157,338B2 |
|  | 4,850,072 | 5,017,508 | 5,063,307 | 5,381,025 | 6,259,123 B1 | 6,534,343    | 6,710,405 B2 | 6,759,692    | 7,063,975 B2 |             |
|  | 4,881,106 | 5,034,796 | 5,187,117 | 5,486,715 | 6,306,728 B1 | 6,583,505    | 6,710,463    | 6,771,478 B2 | 7,071,537    |             |

**Fig. 1. Output Characteristics @  $T_J = 25^\circ\text{C}$**

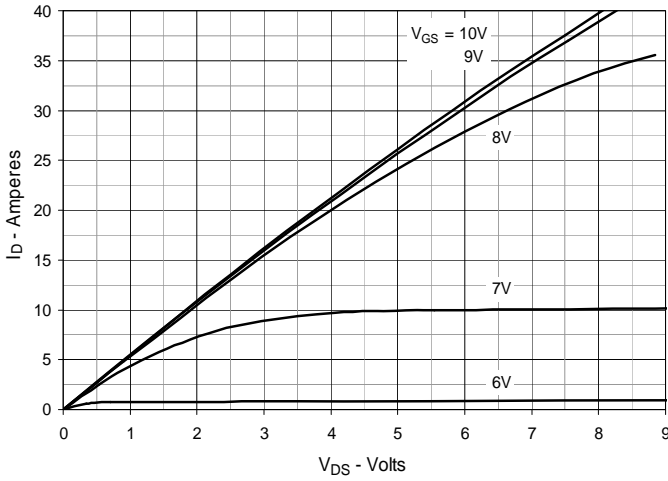

**Fig. 2. Extended Output Characteristics @  $T_J = 25^\circ\text{C}$**

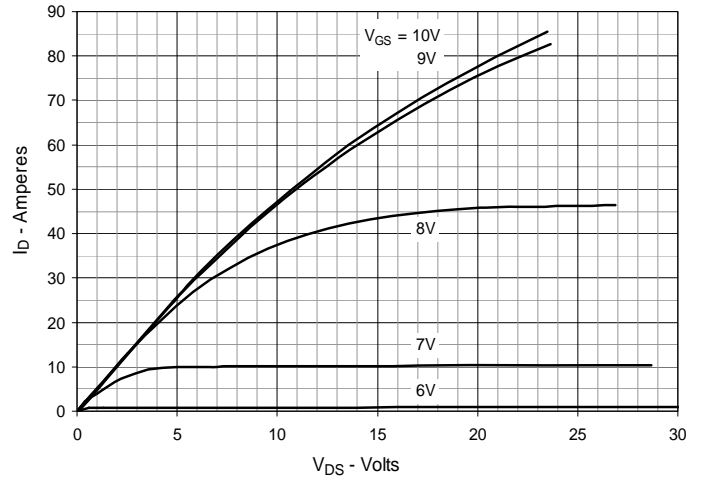

**Fig. 3. Output Characteristics @  $T_J = 125^\circ\text{C}$**

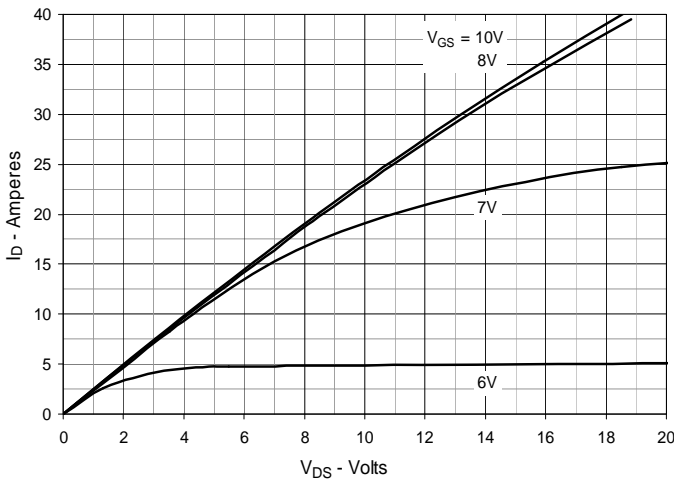

**Fig. 4.  $R_{DS(on)}$  Normalized to  $I_D = 20A$  Value vs. Junction Temperature**

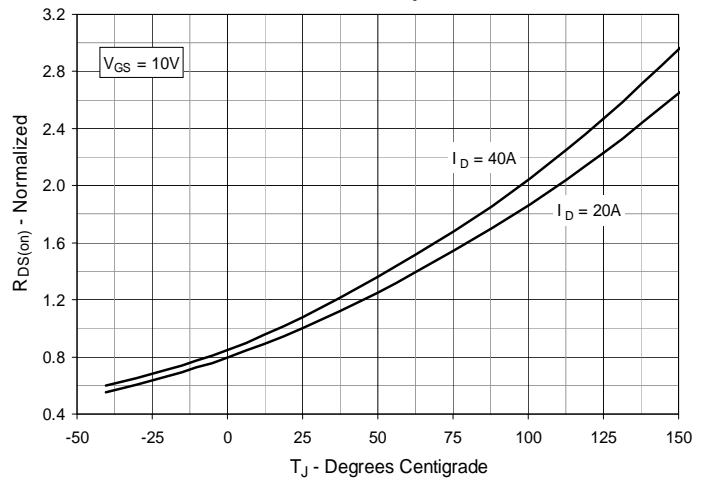

**Fig. 5.  $R_{DS(on)}$  Normalized to  $I_D = 20A$  Value vs. Drain Current**

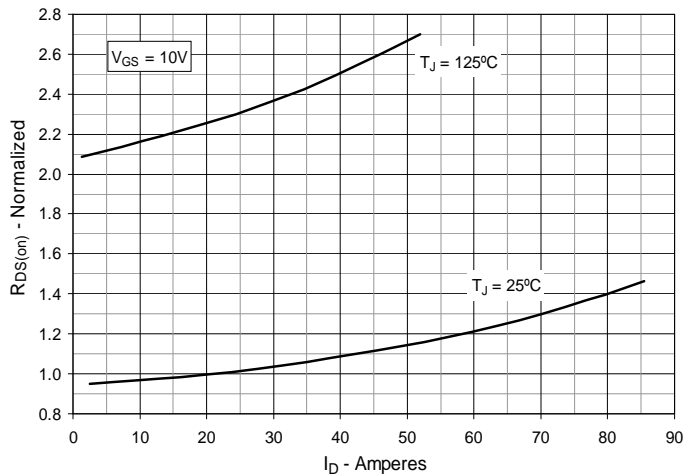

**Fig. 6. Maximum Drain Current vs. Case Temperature**

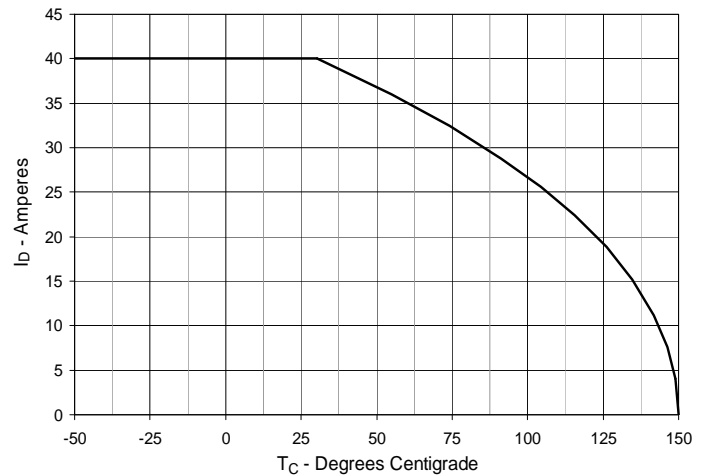

**Fig. 7. Input Admittance**

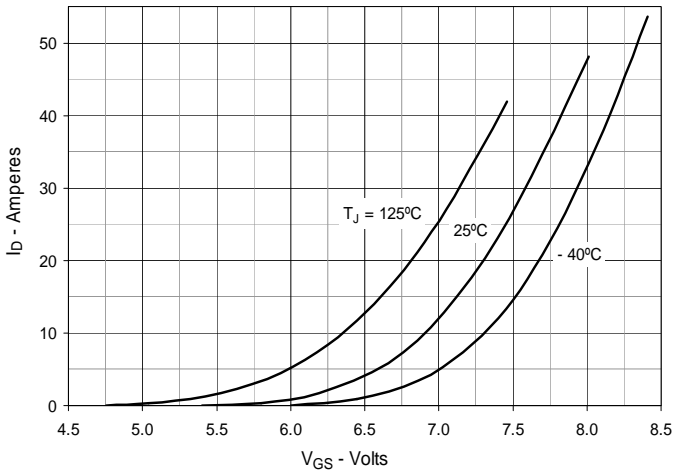

**Fig. 8. Transconductance**

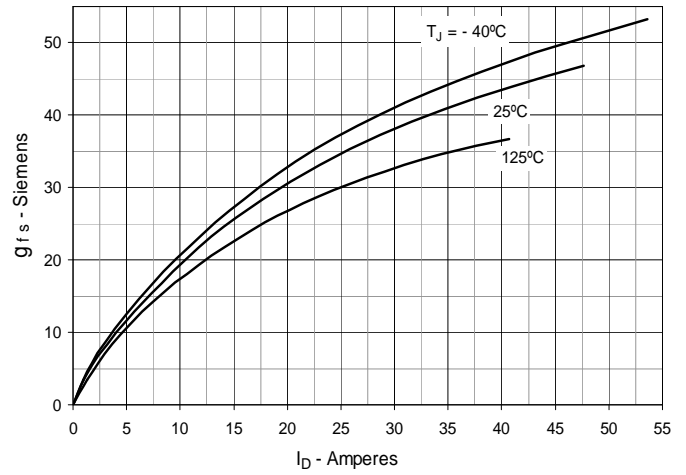

**Fig. 9. Forward Voltage Drop of Intrinsic Diode**

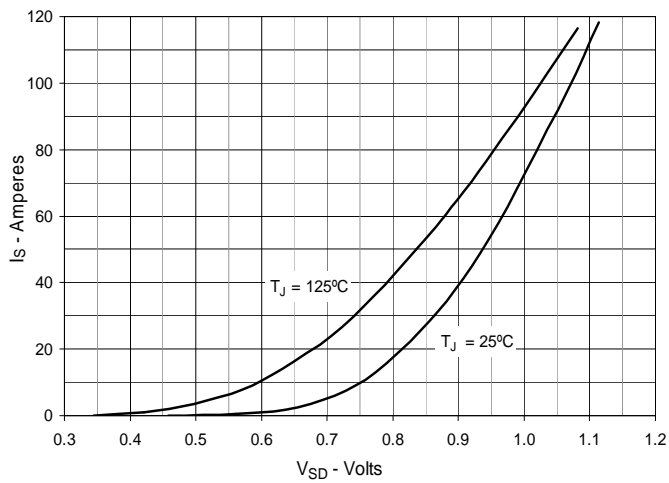

**Fig. 10. Gate Charge**

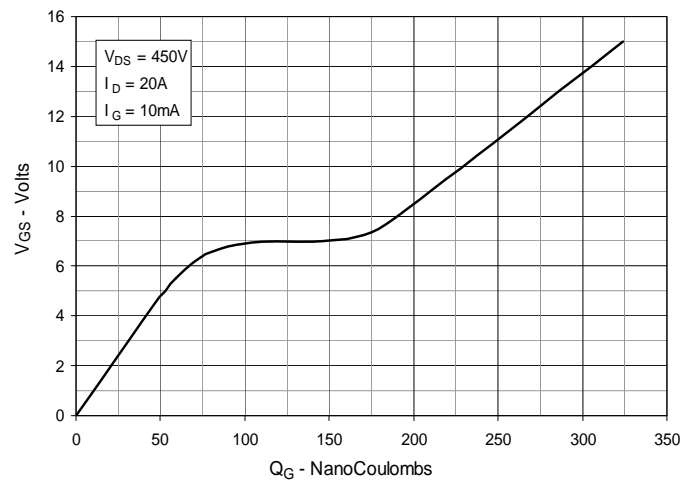

**Fig. 11. Capacitance**

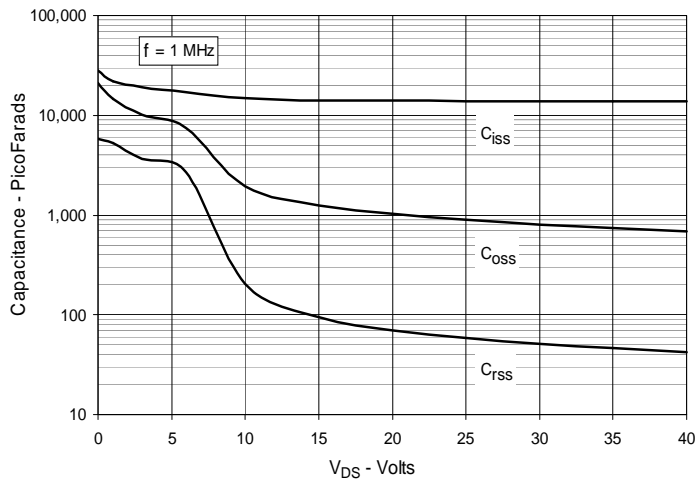

**Fig. 12. Maximum Transient Thermal Impedance**

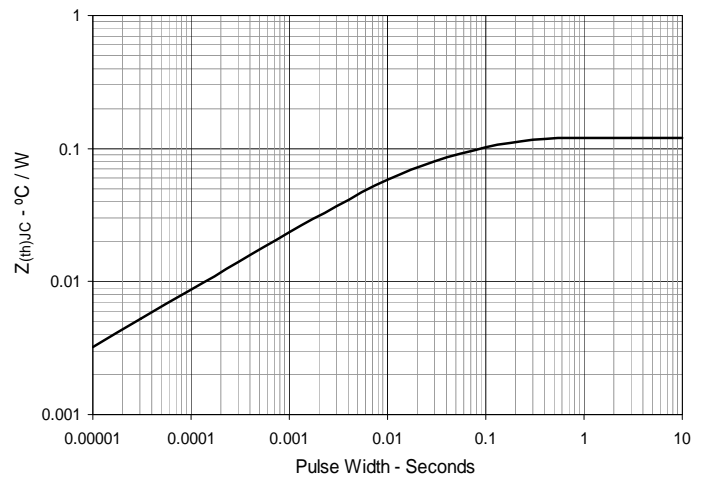



---

Disclaimer Notice - Information furnished is believed to be accurate and reliable. However, users should independently evaluate the suitability of and test each product selected for their own applications. Littelfuse products are not designed for, and may not be used in, all applications. Read complete Disclaimer Notice at [www.littelfuse.com/disclaimer-electronics](http://www.littelfuse.com/disclaimer-electronics).