

**Polar™ HiPerFET™
Power MOSFETs**
**IXFK32N90P
IXFX32N90P**

$$V_{DSS} = 900V$$

$$I_{D25} = 32A$$

$$R_{DS(on)} \leq 300m\Omega$$

N-Channel Enhancement Mode
Avalanche Rated
Fast Intrinsic Rectifier

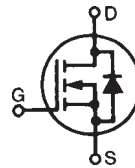

| Symbol | Test Conditions | Maximum Ratings | |
|---------------|--|-------------------|------------|
| V_{DSS} | $T_J = 25^\circ C$ to $150^\circ C$ | 900 | V |
| V_{DGR} | $T_J = 25^\circ C$ to $150^\circ C$, $R_{GS} = 1M\Omega$ | 900 | V |
| V_{GSS} | Continuous | ± 30 | V |
| V_{GSM} | Transient | ± 40 | V |
| I_{D25} | $T_C = 25^\circ C$ | 32 | A |
| I_{DM} | $T_C = 25^\circ C$, Pulse Width Limited by T_{JM} | 80 | A |
| I_A | $T_C = 25^\circ C$ | 16 | A |
| E_{AS} | $T_C = 25^\circ C$ | 2 | J |
| dv/dt | $I_S \leq I_{DM}$, $V_{DD} \leq V_{DSS}$, $T_J \leq 150^\circ C$ | 15 | V/ns |
| P_D | $T_C = 25^\circ C$ | 960 | W |
| T_J | | -55 to +150 | $^\circ C$ |
| T_{JM} | | 150 | $^\circ C$ |
| T_{stg} | | -55 to +150 | $^\circ C$ |
| T_L | 1.6mm (0.062 in.) from Case for 10s | 300 | $^\circ C$ |
| T_{SOLD} | Plastic Body for 10s | 260 | $^\circ C$ |
| M_d | Mounting Torque (TO-264) | 1.13/10 | Nm/lb.in. |
| F_C | Mounting Force (PLUS247) | 20..120 / 4.5..27 | N/lb. |
| Weight | TO-264 | 10 | g |
| | PLUS247 | 6 | g |

TO-264 (IXFK)

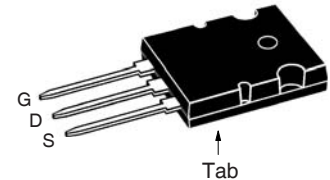

PLUS247 (IXFX)

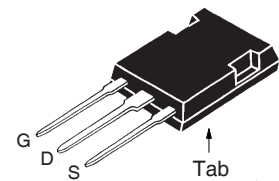

G = Gate D = Drain
S = Source Tab = Drain

Features

- Low $R_{DS(on)}$ and Q_G
- Avalanche Rated
- Low Package Inductance
- Fast Intrinsic Rectifier

Advantages

- High Power Density
- Easy to Mount
- Space Savings

Applications

- Switch-Mode and Resonant-Mode Power Supplies
- DC-DC Converters
- Laser Drivers
- AC and DC Motor Drives
- Robotics and Servo Controls

| Symbol | Test Conditions ($T_J = 25^\circ C$, Unless Otherwise Specified) | Characteristic Values | | |
|--------------|---|-----------------------|------|--------------------|
| | | Min. | Typ. | Max. |
| BV_{DSS} | $V_{GS} = 0V$, $I_D = 3mA$ | 900 | | V |
| $V_{GS(th)}$ | $V_{DS} = V_{GS}$, $I_D = 1mA$ | 3.5 | | 6.5 V |
| I_{GSS} | $V_{GS} = \pm 30V$, $V_{DS} = 0V$ | | | ± 200 nA |
| I_{DSS} | $V_{DS} = V_{DSS}$, $V_{GS} = 0V$ $T_J = 125^\circ C$ | | | 25 μA 2 mA |
| $R_{DS(on)}$ | $V_{GS} = 10V$, $I_D = 0.5 \cdot I_{D25}$, Note 1 | | | 300 m Ω |

| Symbol | Test Conditions ($T_J = 25^\circ\text{C}$, Unless Otherwise Specified) | Characteristic Values | | |
|--------------|--|-----------------------|------|--------------------|
| | | Min. | Typ. | Max. |
| g_{fs} | $V_{DS} = 20\text{V}$, $I_D = 0.5 \cdot I_{D25}$, Note 1 | 13 | 22 | S |
| C_{iss} | $V_{GS} = 0\text{V}$, $V_{DS} = 25\text{V}$, $f = 1\text{MHz}$ | | 10.6 | nF |
| C_{oss} | | | 750 | pF |
| C_{rss} | | | 140 | pF |
| R_{Gi} | Gate Input Resistance | | 1.1 | Ω |
| $t_{d(on)}$ | Resistive Switching Times $V_{GS} = 10\text{V}$, $V_{DS} = 0.5 \cdot V_{DSS}$, $I_D = 0.5 \cdot I_{D25}$ $R_G = 1\Omega$ (External) | | 48 | ns |
| t_r | | | 80 | ns |
| $t_{d(off)}$ | | | 68 | ns |
| t_f | | | 26 | ns |
| $Q_{g(on)}$ | $V_{GS} = 10\text{V}$, $V_{DS} = 0.5 \cdot V_{DSS}$, $I_D = 0.5 \cdot I_{D25}$ | | 215 | nC |
| Q_{gs} | | | 80 | nC |
| Q_{gd} | | | 98 | nC |
| R_{thJC} | | | 0.13 | $^\circ\text{C/W}$ |
| R_{thCS} | | 0.15 | | $^\circ\text{C/W}$ |

Source-Drain Diode

| Symbol | Test Conditions ($T_J = 25^\circ\text{C}$ Unless Otherwise Specified) | Characteristic Values | | |
|----------|---|-----------------------|------|---------------|
| | | Min. | Typ. | Max. |
| I_S | $V_{GS} = 0\text{V}$ | | | 32 A |
| I_{SM} | Repetitive, Pulse Width Limited by T_{JM} | | | 128 A |
| V_{SD} | $I_F = I_S$, $V_{GS} = 0\text{V}$, Note 1 | | | 1.5 V |
| t_{rr} | $I_F = 16\text{A}$, $-di/dt = 100\text{A}/\mu\text{s}$ $V_R = 100\text{V}$, $V_{GS} = 0\text{V}$ | | | 300 ns |
| Q_{RM} | | | 1.9 | μC |
| I_{RM} | | | 14 | A |

Note: 1. Pulse test, $t \leq 300\mu\text{s}$, duty cycle, $d \leq 2\%$.

ADVANCE TECHNICAL INFORMATION

The product presented herein is under development. The Technical Specifications offered are derived from a subjective evaluation of the design, based upon prior knowledge and experience, and constitute a "considered reflection" of the anticipated result. IXYS reserves the right to change limits, test conditions, and dimensions without notice.

IXYS Reserves the Right to Change Limits, Test Conditions, and Dimensions.

IXYS MOSFETs and IGBTs are covered by one or more of the following U.S. patents:

| | | | | | | | | | |
|-----------|-----------|-----------|-----------|--------------|--------------|--------------|--------------|--------------|-------------|
| 4,835,592 | 4,931,844 | 5,049,961 | 5,237,481 | 6,162,665 | 6,404,065 B1 | 6,683,344 | 6,727,585 | 7,005,734 B2 | 7,157,338B2 |
| 4,850,072 | 5,017,508 | 5,063,307 | 5,381,025 | 6,259,123 B1 | 6,534,343 | 6,710,405 B2 | 6,759,692 | 7,063,975 B2 | |
| 4,881,106 | 5,034,796 | 5,187,117 | 5,486,715 | 6,306,728 B1 | 6,583,505 | 6,710,463 | 6,771,478 B2 | 7,071,537 | |

TO-264 Outline

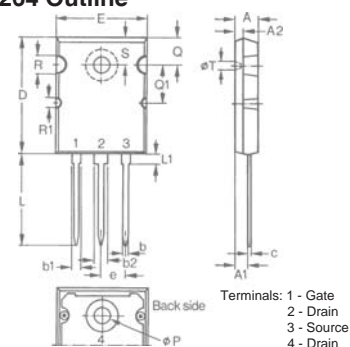

| Dim. | Millimeter | | Inches | |
|------|------------|-------|----------|-------|
| | Min. | Max. | Min. | Max. |
| A | 4.82 | 5.13 | .190 | .202 |
| A1 | 2.54 | 2.89 | .100 | .114 |
| A2 | 2.00 | 2.10 | .079 | .083 |
| b | 1.12 | 1.42 | .044 | .056 |
| b1 | 2.39 | 2.69 | .094 | .106 |
| b2 | 2.90 | 3.09 | .114 | .122 |
| c | 0.53 | 0.83 | .021 | .033 |
| D | 25.91 | 26.16 | 1.020 | 1.030 |
| E | 19.81 | 19.96 | .780 | .786 |
| e | 5.46 BSC | | .215 BSC | |
| J | 0.00 | 0.25 | .000 | .010 |
| K | 0.00 | 0.25 | .000 | .010 |
| L | 20.32 | 20.83 | .800 | .820 |
| L1 | 2.29 | 2.59 | .090 | .102 |
| P | 3.17 | 3.66 | .125 | .144 |
| Q | 6.07 | 6.27 | .239 | .247 |
| Q1 | 8.38 | 8.69 | .330 | .342 |
| R | 3.81 | 4.32 | .150 | .170 |
| R1 | 1.78 | 2.29 | .070 | .090 |
| S | 6.04 | 6.30 | .238 | .248 |
| T | 1.57 | 1.83 | .062 | .072 |

PLUS247™ Outline

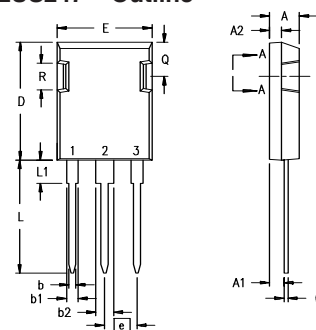

| Dim. | Millimeter | | Inches | |
|----------------|------------|-------|----------|-------|
| | Min. | Max. | Min. | Max. |
| A | 4.83 | 5.21 | .190 | .205 |
| A ₁ | 2.29 | 2.54 | .090 | .100 |
| A ₂ | 1.91 | 2.16 | .075 | .085 |
| b | 1.14 | 1.40 | .045 | .055 |
| b ₁ | 1.91 | 2.13 | .075 | .084 |
| b ₂ | 2.92 | 3.12 | .115 | .123 |
| C | 0.61 | 0.80 | .024 | .031 |
| D | 20.80 | 21.34 | .819 | .840 |
| E | 15.75 | 16.13 | .620 | .635 |
| e | 5.45 BSC | | .215 BSC | |
| L | 19.81 | 20.32 | .780 | .800 |
| L1 | 3.81 | 4.32 | .150 | .170 |
| Q | 5.59 | 6.20 | .220 | 0.244 |
| R | 4.32 | 4.83 | .170 | .190 |

Fig. 1. Output Characteristics @ $T_J = 25^\circ\text{C}$

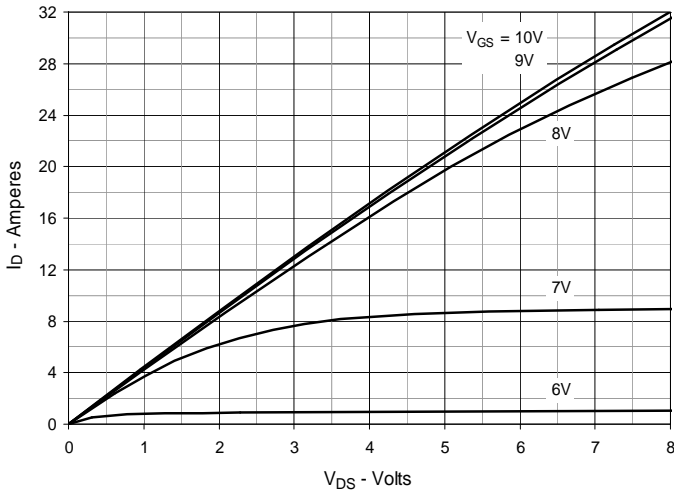

Fig. 2. Extended Output Characteristics @ $T_J = 25^\circ\text{C}$

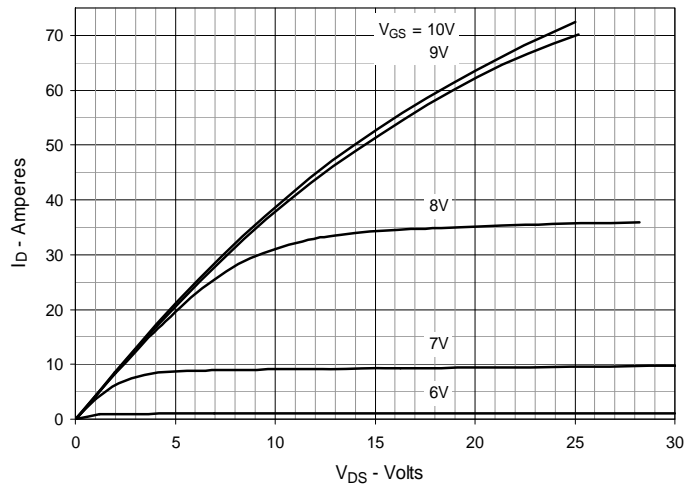

Fig. 3. Output Characteristics @ $T_J = 125^\circ\text{C}$

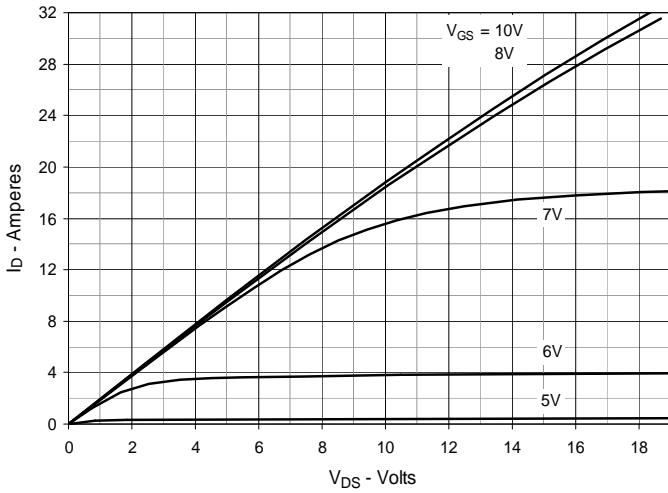

Fig. 4. $R_{DS(on)}$ Normalized to $I_D = 16\text{A}$ Value vs. Junction Temperature

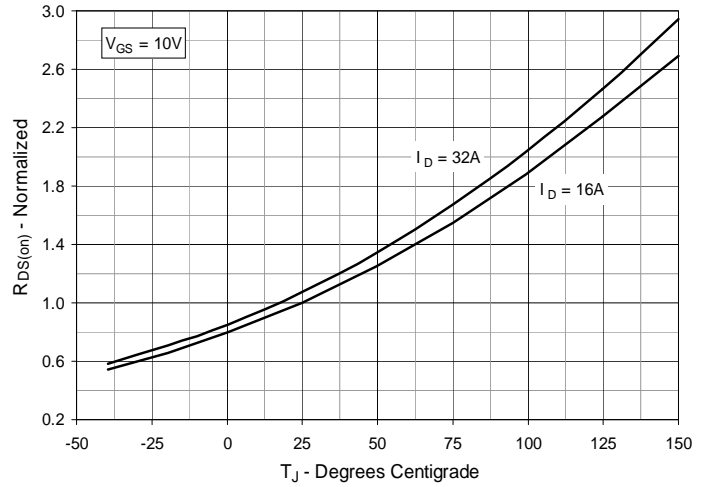

Fig. 5. $R_{DS(on)}$ Normalized to $I_D = 16\text{A}$ Value vs. Drain Current

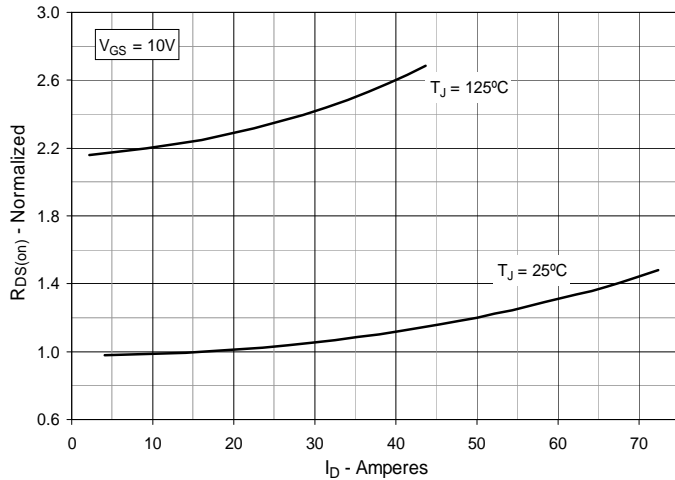

Fig. 6. Maximum Drain Current vs. Case Temperature

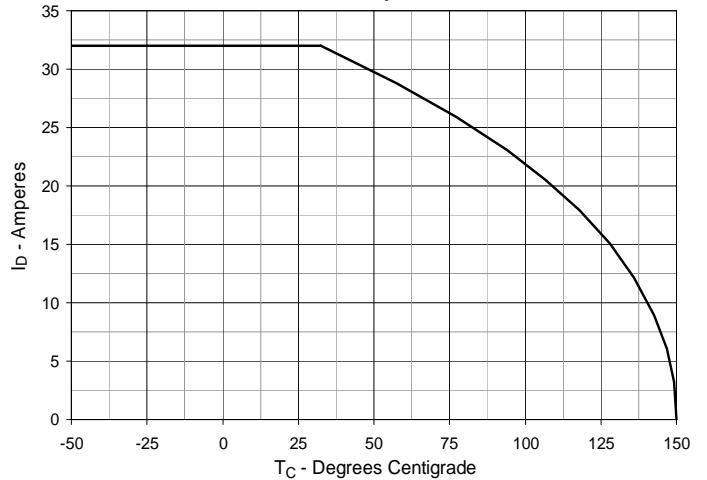

Fig. 7. Input Admittance

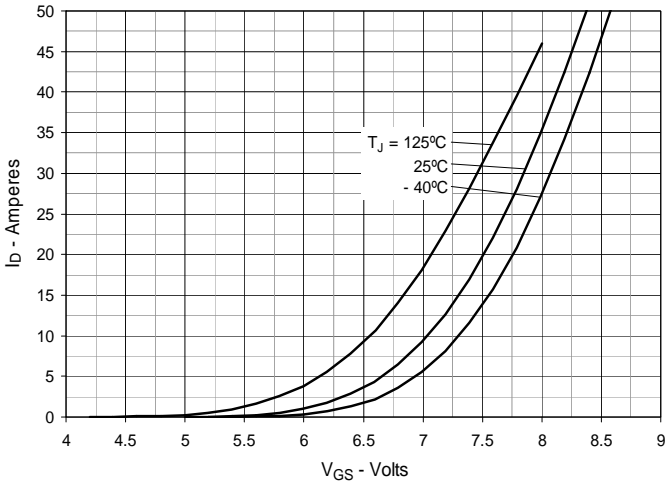

Fig. 8. Transconductance

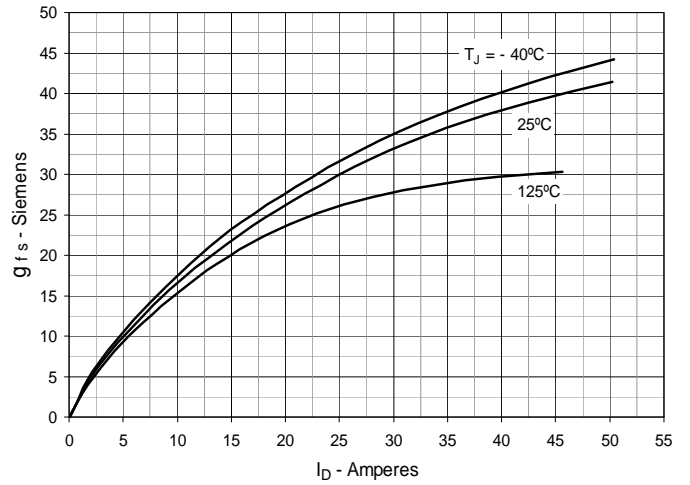

Fig. 9. Forward Voltage Drop of Intrinsic Diode

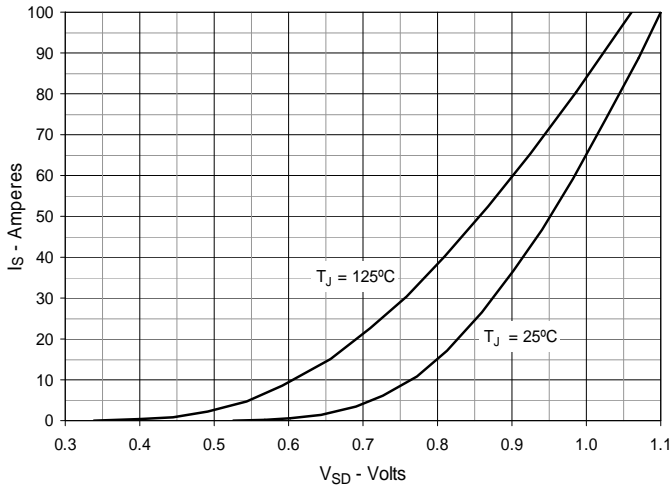

Fig. 10. Gate Charge

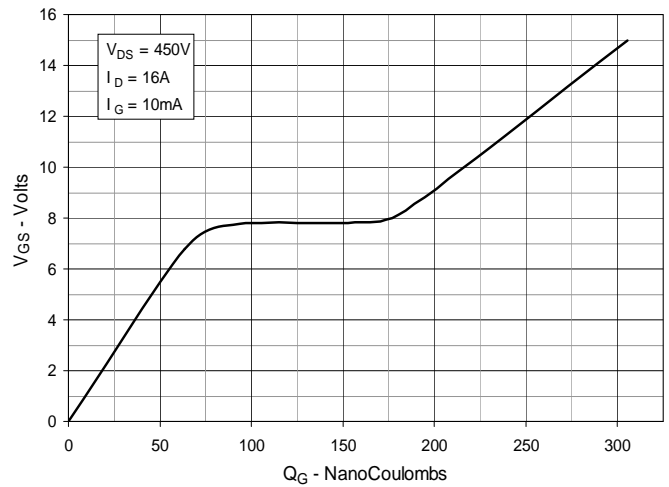

Fig. 11. Capacitance

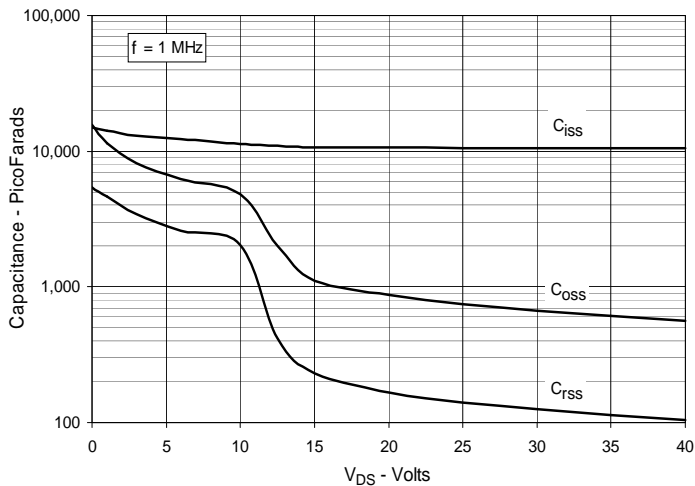

Fig. 12. Forward-Bias Safe Operating Area

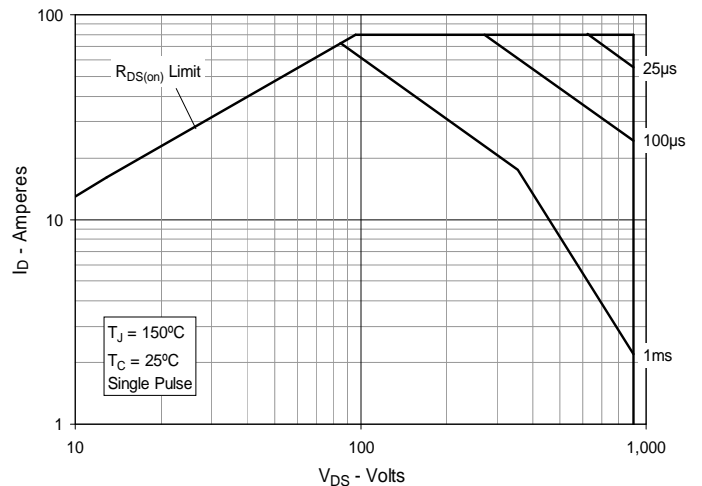
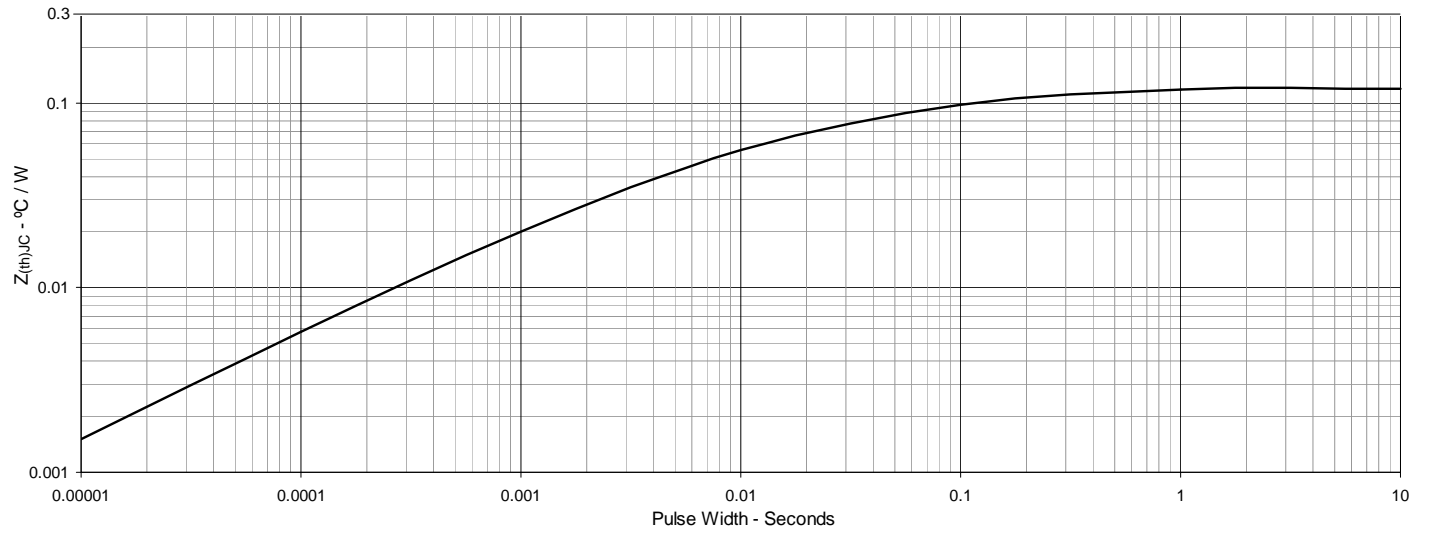

Fig. 13 Maximum Transient Thermal Impedance





Disclaimer Notice - Information furnished is believed to be accurate and reliable. However, users should independently evaluate the suitability of and test each product selected for their own applications. Littelfuse products are not designed for, and may not be used in, all applications. Read complete Disclaimer Notice at www.littelfuse.com/disclaimer-electronics.