

PolarHT™ HiPerFET Power MOSFET

IXFH 120N15P
IXFT 120N15P

V_{DSS} = 150 V
I_{D25} = 120 A
R_{DS(on)} ≤ 16 mΩ
t_{rr} ≤ 200 ns

N-Channel Enhancement Mode
Avalanche Energy Rated
Fast Intrinsic Diode



Symbol	Test Conditions	Maximum Ratings	
V _{DSS}	T _J = 25°C to 175°C	150	V
V _{DGR}	T _J = 25°C to 175°C; R _{GS} = 1 MΩ	150	V
V _{DSS}	Continuous	±20	V
V _{GSM}	Transient	±30	V
I _{D25}	T _C = 25°C	120	A
I _{L(RMS)}	External lead current limit	75	A
I _{DM}	T _C = 25°C, pulse width limited by T _{JM}	260	A
I _{AR}	T _C = 25°C	60	A
E _{AR}	T _C = 25°C	60	mJ
E _{AS}	T _C = 25°C	2.0	J
dv/dt	I _S ≤ I _{DM} , di/dt ≤ 100 A/μs, V _{DD} ≤ V _{DSS} , T _J ≤ 150°C, R _G = 4 Ω	10	V/ns
P _D	T _C = 25°C	600	W
T _J		-55 ... +175	°C
T _{JM}		175	°C
T _{stg}		-55 ... +150	°C
T _L	1.6 mm (0.062 in.) from case for 10 s	300	°C
T _{SOLD}	Plastic case for 10 s	260	°C
M _d	Mounting torque (TO-3P)	1.13/10	Nm/lb.in.
Weight	TO-247	6.0	g
	TO-268	5.0	g

TO-247 (IXFH)

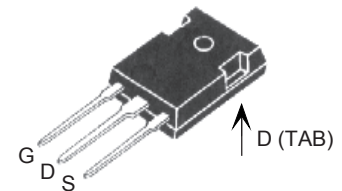

TO-268 (IXFT)

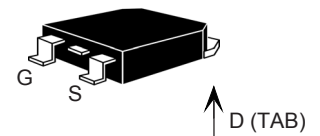

G = Gate D = Drain
S = Source TAB = Drain

Features

- † International standard packages
- † Unclamped Inductive Switching (UIS) rated
- † Low package inductance
 - easy to drive and to protect

Advantages

- † Easy to mount
- † Space savings
- † High power density

Symbol	Test Conditions	Characteristic Values		
		Min.	Typ.	Max.
BV _{DSS}	V _{GS} = 0 V, I _D = 250 μA	150		V
V _{GS(th)}	V _{DS} = V _{GS} , I _D = 4 mA	3.0		5.0 V
I _{GSS}	V _{GS} = ±20 V _{DC} , V _{DS} = 0			±100 nA
I _{DSS}	V _{DS} = V _{DSS} V _{GS} = 0 V T _J = 175°C			25 μA
				500 μA
R _{DS(on)}	V _{GS} = 10 V, I _D = 0.5 I _{D25} Pulse test, t ≤ 300 μs, duty cycle d ≤ 2 %			16 mΩ

Symbol	Test Conditions	Characteristic Values		
		(T _J = 25° C, unless otherwise specified)		
		Min.	Typ.	Max.
g_{fs}	V _{DS} = 10 V; I _D = 0.5 I _{D25} , pulse test	40	60	S
C_{iss}	V _{GS} = 0 V, V _{DS} = 25 V, f = 1 MHz		4900	pF
C_{oss}			1300	pF
C_{rss}			330	pF
t_{d(on)}	V _{GS} = 10 V, V _{DS} = 0.5 V _{DSS} , I _D = 60 A R _G = 4 Ω (External)		33	ns
t_r			42	ns
t_{d(off)}			85	ns
t_f			26	ns
Q_{g(on)}	V _{GS} = 10 V, V _{DS} = 0.5 V _{DSS} , I _D = 0.5 I _{D25}		150	nC
Q_{gs}			40	nC
Q_{gd}			80	nC
R_{thJC}	(TO-3P)			0.25° C/W
R_{thCS}			0.21	° C/W

Symbol	Test Conditions	Characteristic Values		
		(T _J = 25° C, unless otherwise specified)		
		Min.	Typ.	Max.
I_s	V _{GS} = 0 V			120 A
I_{SM}	Repetitive			260 A
V_{SD}	I _F = I _S , V _{GS} = 0 V, Pulse test, t ≤ 300 μs, duty cycle d ≤ 2 %			1.5 V
t_{rr}	I _F = 25 A, -di/dt = 100 A/μs V _R = 100 V, V _{GS} = 0 V			200 ns
Q_{RM}			600	nC
I_{RM}			6	A

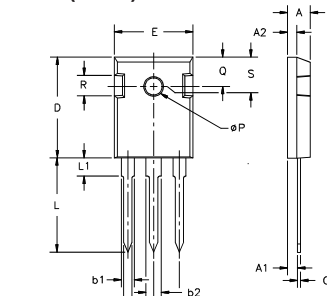
TO-247 (IXFH) Outline

Terminals: 1 - Gate
2 - Drain
3 - Source
Tab - Drain

Dim.	Millimeter		Inches	
	Min.	Max.	Min.	Max.
A	4.7	5.3	.185	.209
A ₁	2.2	2.54	.087	.102
A ₂	2.2	2.6	.059	.098
b	1.0	1.4	.040	.055
b ₁	1.65	2.13	.065	.084
b ₂	2.87	3.12	.113	.123
C	.4	.8	.016	.031
D	20.80	21.46	.819	.845
E	15.75	16.26	.610	.640
e	5.20	5.72	0.205	0.225
L	19.81	20.32	.780	.800
L1		4.50		.177
ØP	3.55	3.65	.140	.144
Q	5.89	6.40	0.232	0.252
R	4.32	5.49	.170	.216
S	6.15	BSC	242	BSC

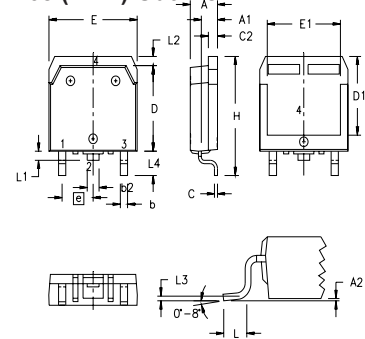
TO-268 (IXFT) Outline

Terminals: 1 - Gate
2 - Drain
3 - Source
Tab - Drain

SYM	INCHES		MILLIMETERS	
	MIN	MAX	MIN	MAX
A	.193	.201	4.90	5.10
A1	.106	.114	2.70	2.90
A2	.001	.010	0.02	0.25
b	.045	.057	1.15	1.45
b2	.075	.083	1.90	2.10
C	.016	.026	0.40	0.65
C2	.057	.063	1.45	1.60
D	.543	.551	13.80	14.00
D1	.488	.500	12.40	12.70
E	.624	.632	15.85	16.05
E1	.524	.535	13.30	13.60
e		.215 BSC		5.45 BSC
H	.736	.752	18.70	19.10
L	.094	.106	2.40	2.70
L1	.047	.055	1.20	1.40
L2	.039	.045	1.00	1.15
L3		.010 BSC		0.25 BSC
L4	.150	.161	3.80	4.10

IXYS reserves the right to change limits, test conditions, and dimensions.

IXYS MOSFETs and IGBTs are covered by 4,835,592 4,931,844 5,049,961 5,237,481 6,162,665 6,404,065 B1 6,683,344 6,727,585
 one or more of the following U.S. patents: 4,850,072 5,017,508 5,063,307 5,381,025 6,259,123 B1 6,534,343 6,710,405 B2 6,759,692
 4,881,106 5,034,796 5,187,117 5,486,715 6,306,728 B1 6,583,505 6,710,463 6,771,478 B2

Fig. 1. Output Characteristics
@ 25°C



Fig. 2. Extended Output Characteristics
@ 25°C

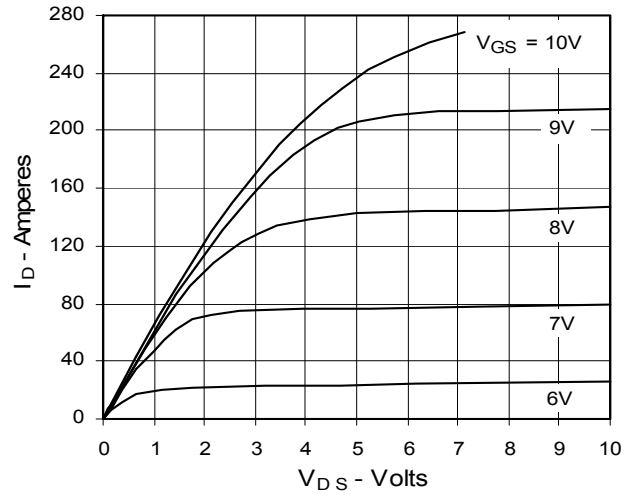

Fig. 3. Output Characteristics
@ 150°C

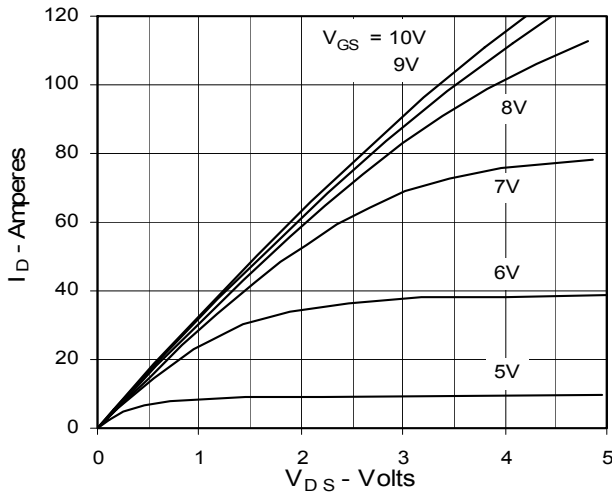

Fig. 4. $R_{DS(on)}$ Normalized to 0.5 I_{D25} Value vs. Junction Temperature

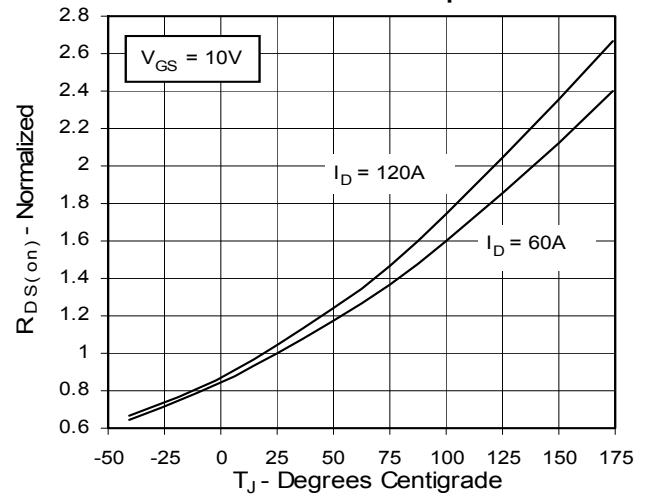

Fig. 5. $R_{DS(on)}$ Normalized to 0.5 I_{D25} Value vs. Drain Current



Fig. 6. Drain Current vs. Case Temperature

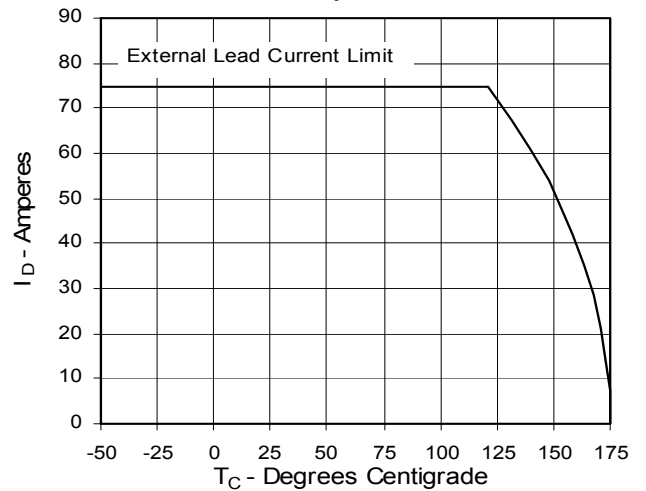

Fig. 7. Input Admittance

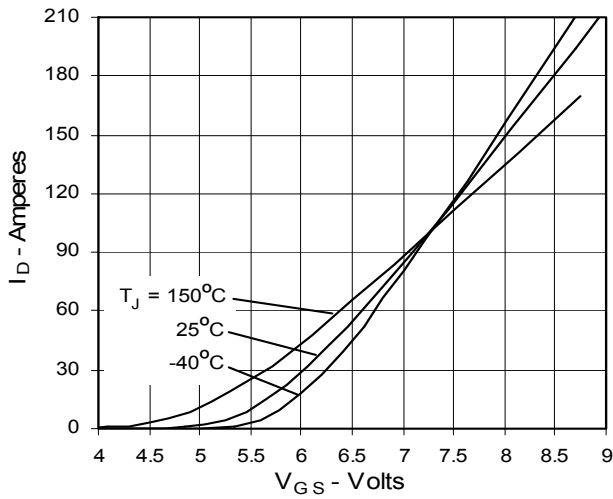

Fig. 8. Transconductance

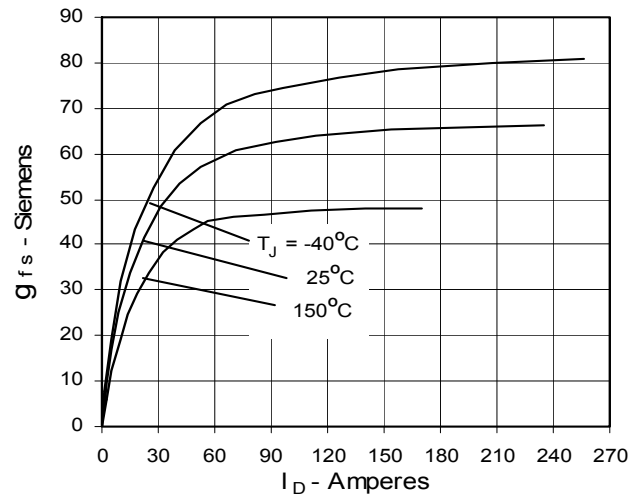

Fig. 9. Source Current vs. Source-To-Drain Voltage

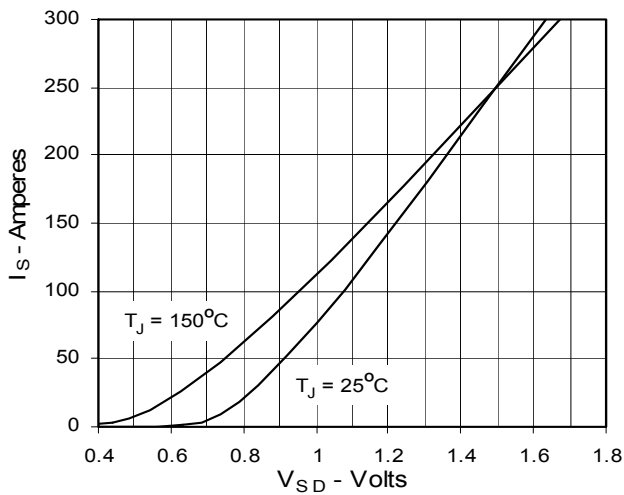

Fig. 10. Gate Charge

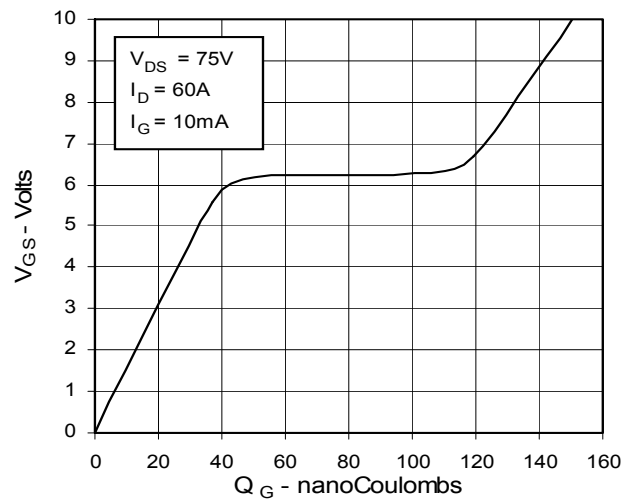

Fig. 11. Capacitance

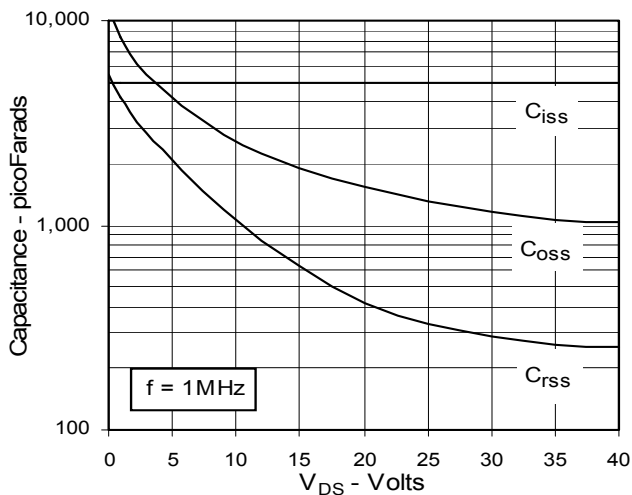

Fig. 12. Forward-Bias Safe Operating Area

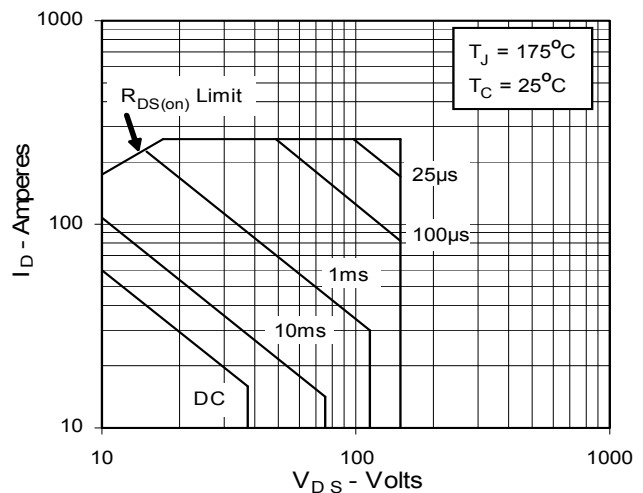
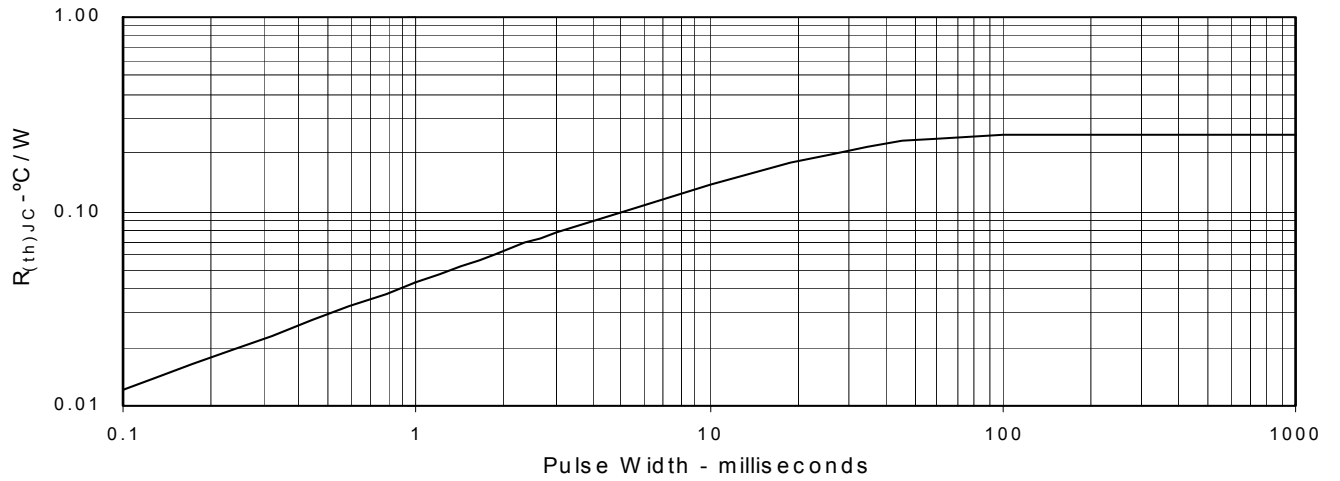

Fig. 13. Maximum Transient Thermal Resistance





Disclaimer Notice - Information furnished is believed to be accurate and reliable. However, users should independently evaluate the suitability of and test each product selected for their own applications. Littelfuse products are not designed for, and may not be used in, all applications. Read complete Disclaimer Notice at www.littelfuse.com/disclaimer-electronics.