

# PolarHT™ HiPerFET Power MOSFET

**IXFH 120N15P**  
**IXFT 120N15P**

**V<sub>DSS</sub> = 150 V**  
**I<sub>D25</sub> = 120 A**  
**R<sub>DS(on)</sub> ≤ 16 mΩ**  
**t<sub>rr</sub> ≤ 200 ns**

N-Channel Enhancement Mode  
Avalanche Energy Rated  
Fast Intrinsic Diode



Symbol	Test Conditions	Maximum Ratings	
V <sub>DSS</sub>	T <sub>J</sub> = 25°C to 175°C	150	V
V <sub>DGR</sub>	T <sub>J</sub> = 25°C to 175°C; R <sub>GS</sub> = 1 MΩ	150	V
V <sub>DSS</sub>	Continuous	±20	V
V <sub>GSM</sub>	Transient	±30	V
I <sub>D25</sub>	T <sub>C</sub> = 25°C	120	A
I <sub>L(RMS)</sub>	External lead current limit	75	A
I <sub>DM</sub>	T <sub>C</sub> = 25°C, pulse width limited by T <sub>JM</sub>	260	A
I <sub>AR</sub>	T <sub>C</sub> = 25°C	60	A
E <sub>AR</sub>	T <sub>C</sub> = 25°C	60	mJ
E <sub>AS</sub>	T <sub>C</sub> = 25°C	2.0	J
dv/dt	I <sub>S</sub> ≤ I <sub>DM</sub> , di/dt ≤ 100 A/μs, V <sub>DD</sub> ≤ V <sub>DSS</sub> , T <sub>J</sub> ≤ 150°C, R <sub>G</sub> = 4 Ω	10	V/ns
P <sub>D</sub>	T <sub>C</sub> = 25°C	600	W
T <sub>J</sub>		-55 ... +175	°C
T <sub>JM</sub>		175	°C
T <sub>stg</sub>		-55 ... +150	°C
T <sub>L</sub>	1.6 mm (0.062 in.) from case for 10 s	300	°C
T <sub>SOLD</sub>	Plastic case for 10 s	260	°C
M <sub>d</sub>	Mounting torque (TO-3P)	1.13/10	Nm/lb.in.
Weight	TO-247	6.0	g
	TO-268	5.0	g

TO-247 (IXFH)

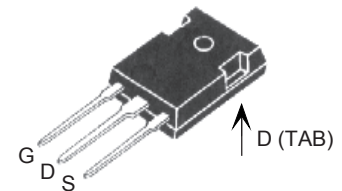

TO-268 (IXFT)

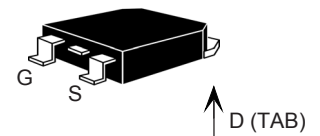

G = Gate      D = Drain  
S = Source      TAB = Drain

## Features

- † International standard packages
- † Unclamped Inductive Switching (UIS) rated
- † Low package inductance
  - easy to drive and to protect

## Advantages

- † Easy to mount
- † Space savings
- † High power density

Symbol	Test Conditions	Characteristic Values		
		Min.	Typ.	Max.
BV <sub>DSS</sub>	V <sub>GS</sub> = 0 V, I <sub>D</sub> = 250 μA	150		V
V <sub>GS(th)</sub>	V <sub>DS</sub> = V <sub>GS</sub> , I <sub>D</sub> = 4 mA	3.0		5.0 V
I <sub>GSS</sub>	V <sub>GS</sub> = ±20 V <sub>DC</sub> , V <sub>DS</sub> = 0			±100 nA
I <sub>DSS</sub>	V <sub>DS</sub> = V <sub>DSS</sub> V <sub>GS</sub> = 0 V      T <sub>J</sub> = 175°C			25 μA
				500 μA
R <sub>DS(on)</sub>	V <sub>GS</sub> = 10 V, I <sub>D</sub> = 0.5 I <sub>D25</sub> Pulse test, t ≤ 300 μs, duty cycle d ≤ 2 %			16 mΩ

Symbol	Test Conditions	Characteristic Values		
		(T <sub>J</sub> = 25° C, unless otherwise specified)		
		Min.	Typ.	Max.
<b>g<sub>fs</sub></b>	V <sub>DS</sub> = 10 V; I <sub>D</sub> = 0.5 I <sub>D25</sub> , pulse test	40	60	S
<b>C<sub>iss</sub></b>	V <sub>GS</sub> = 0 V, V <sub>DS</sub> = 25 V, f = 1 MHz		4900	pF
<b>C<sub>oss</sub></b>			1300	pF
<b>C<sub>rss</sub></b>			330	pF
<b>t<sub>d(on)</sub></b>	V <sub>GS</sub> = 10 V, V <sub>DS</sub> = 0.5 V <sub>DSS</sub> , I <sub>D</sub> = 60 A R <sub>G</sub> = 4 Ω (External)		33	ns
<b>t<sub>r</sub></b>			42	ns
<b>t<sub>d(off)</sub></b>			85	ns
<b>t<sub>f</sub></b>			26	ns
<b>Q<sub>g(on)</sub></b>	V <sub>GS</sub> = 10 V, V <sub>DS</sub> = 0.5 V <sub>DSS</sub> , I <sub>D</sub> = 0.5 I <sub>D25</sub>		150	nC
<b>Q<sub>gs</sub></b>			40	nC
<b>Q<sub>gd</sub></b>			80	nC
<b>R<sub>thJC</sub></b>	(TO-3P)			0.25° C/W
<b>R<sub>thCS</sub></b>			0.21	° C/W

Symbol	Test Conditions	Characteristic Values		
		(T <sub>J</sub> = 25° C, unless otherwise specified)		
		Min.	Typ.	Max.
<b>I<sub>s</sub></b>	V <sub>GS</sub> = 0 V			120 A
<b>I<sub>SM</sub></b>	Repetitive			260 A
<b>V<sub>SD</sub></b>	I <sub>F</sub> = I <sub>S</sub> , V <sub>GS</sub> = 0 V, Pulse test, t ≤ 300 μs, duty cycle d ≤ 2 %			1.5 V
<b>t<sub>rr</sub></b>	I <sub>F</sub> = 25 A, -di/dt = 100 A/μs V <sub>R</sub> = 100 V, V <sub>GS</sub> = 0 V			200 ns
<b>Q<sub>RM</sub></b>			600	nC
<b>I<sub>RM</sub></b>			6	A

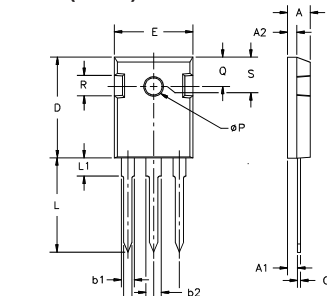
**TO-247 (IXFH) Outline**

Terminals: 1 - Gate  
2 - Drain  
3 - Source  
Tab - Drain

Dim.	Millimeter		Inches	
	Min.	Max.	Min.	Max.
A	4.7	5.3	.185	.209
A <sub>1</sub>	2.2	2.54	.087	.102
A <sub>2</sub>	2.2	2.6	.059	.098
b	1.0	1.4	.040	.055
b <sub>1</sub>	1.65	2.13	.065	.084
b <sub>2</sub>	2.87	3.12	.113	.123
C	.4	.8	.016	.031
D	20.80	21.46	.819	.845
E	15.75	16.26	.610	.640
e	5.20	5.72	0.205	0.225
L	19.81	20.32	.780	.800
L1		4.50		.177
ØP	3.55	3.65	.140	.144
Q	5.89	6.40	0.232	0.252
R	4.32	5.49	.170	.216
S	6.15	BSC	242	BSC

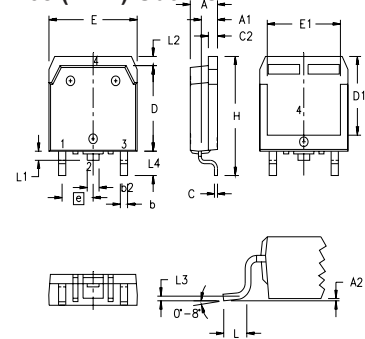
**TO-268 (IXFT) Outline**

Terminals: 1 - Gate  
2 - Drain  
3 - Source  
Tab - Drain

SYM	INCHES		MILLIMETERS	
	MIN	MAX	MIN	MAX
A	.193	.201	4.90	5.10
A1	.106	.114	2.70	2.90
A2	.001	.010	0.02	0.25
b	.045	.057	1.15	1.45
b2	.075	.083	1.90	2.10
C	.016	.026	0.40	0.65
C2	.057	.063	1.45	1.60
D	.543	.551	13.80	14.00
D1	.488	.500	12.40	12.70
E	.624	.632	15.85	16.05
E1	.524	.535	13.30	13.60
e		.215 BSC		5.45 BSC
H	.736	.752	18.70	19.10
L	.094	.106	2.40	2.70
L1	.047	.055	1.20	1.40
L2	.039	.045	1.00	1.15
L3		.010 BSC		0.25 BSC
L4	.150	.161	3.80	4.10

IXYS reserves the right to change limits, test conditions, and dimensions.

IXYS MOSFETs and IGBTs are covered by 4,835,592 4,931,844 5,049,961 5,237,481 6,162,665 6,404,065 B1 6,683,344 6,727,585  
 one or more of the following U.S. patents: 4,850,072 5,017,508 5,063,307 5,381,025 6,259,123 B1 6,534,343 6,710,405 B2 6,759,692  
 4,881,106 5,034,796 5,187,117 5,486,715 6,306,728 B1 6,583,505 6,710,463 6,771,478 B2

**Fig. 1. Output Characteristics**  
**@ 25°C**



**Fig. 2. Extended Output Characteristics**  
**@ 25°C**

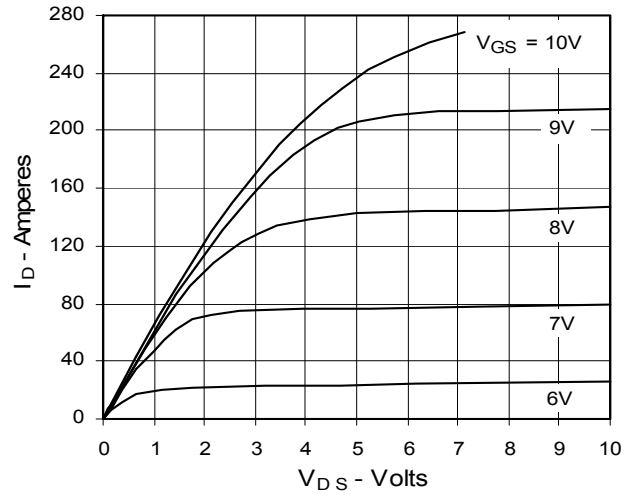

**Fig. 3. Output Characteristics**  
**@ 150°C**

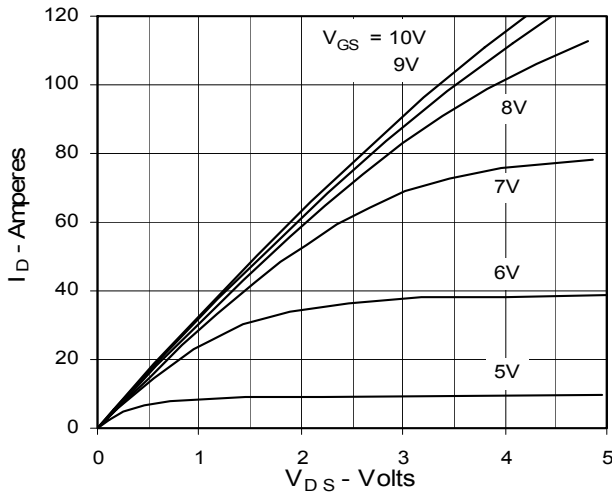

**Fig. 4.  $R_{DS(on)}$  Normalized to 0.5  $I_{D25}$  Value vs. Junction Temperature**

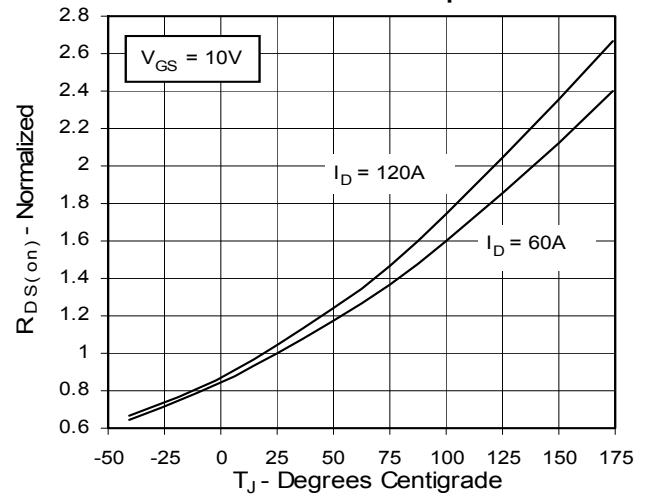

**Fig. 5.  $R_{DS(on)}$  Normalized to 0.5  $I_{D25}$  Value vs. Drain Current**



**Fig. 6. Drain Current vs. Case Temperature**

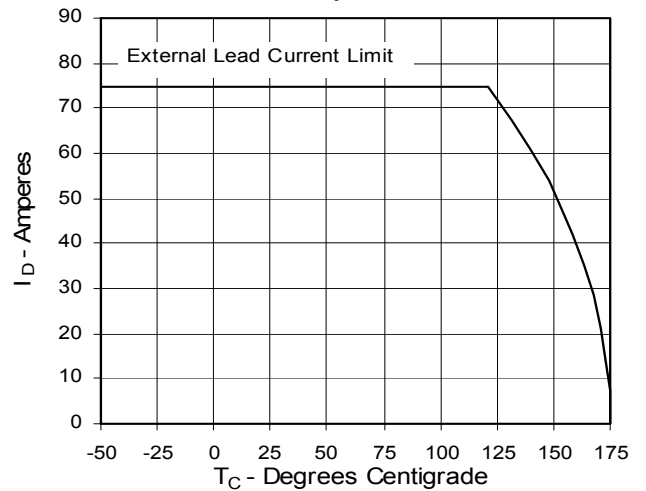

**Fig. 7. Input Admittance**

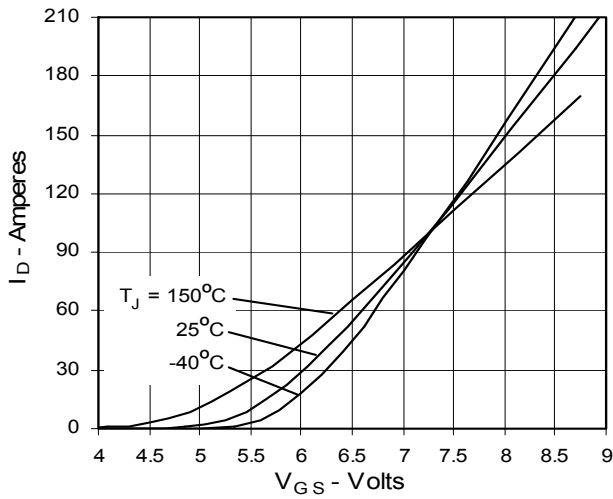

**Fig. 8. Transconductance**

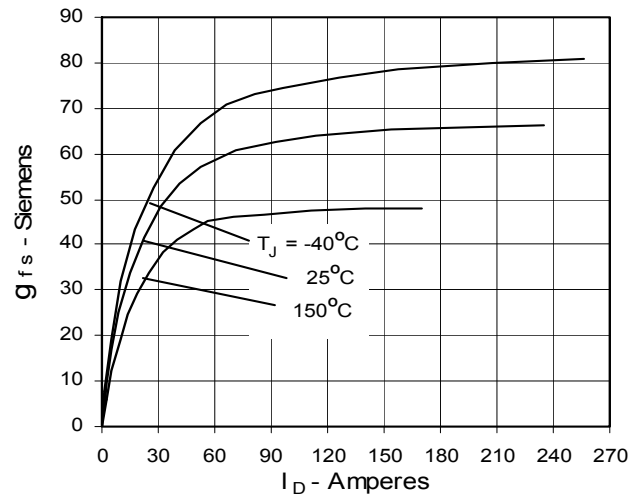

**Fig. 9. Source Current vs. Source-To-Drain Voltage**

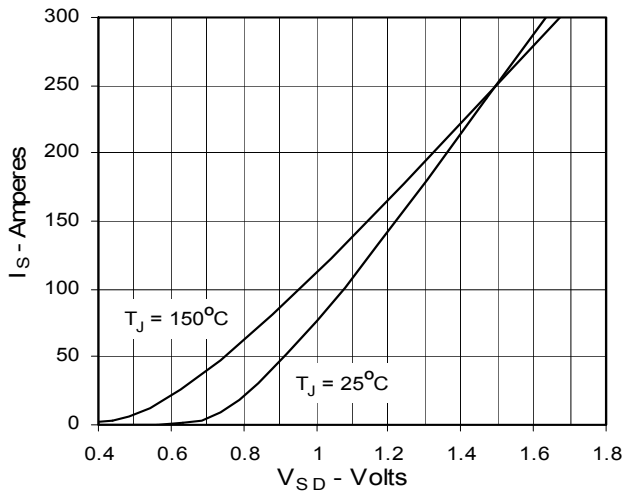

**Fig. 10. Gate Charge**

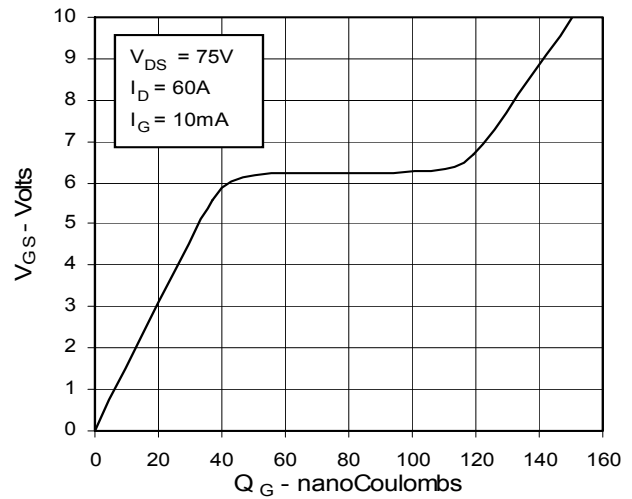

**Fig. 11. Capacitance**

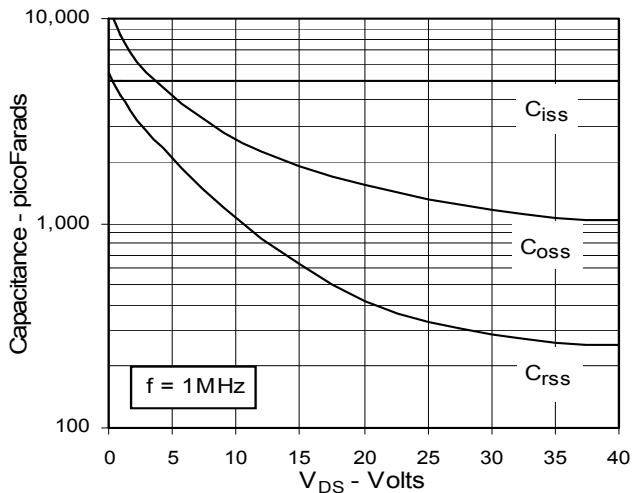

**Fig. 12. Forward-Bias Safe Operating Area**

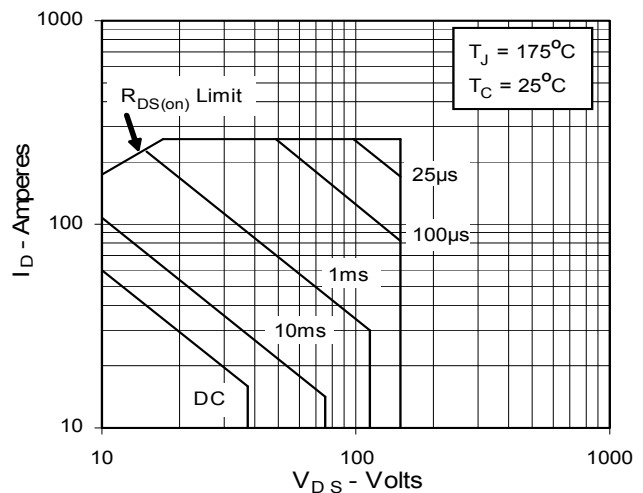
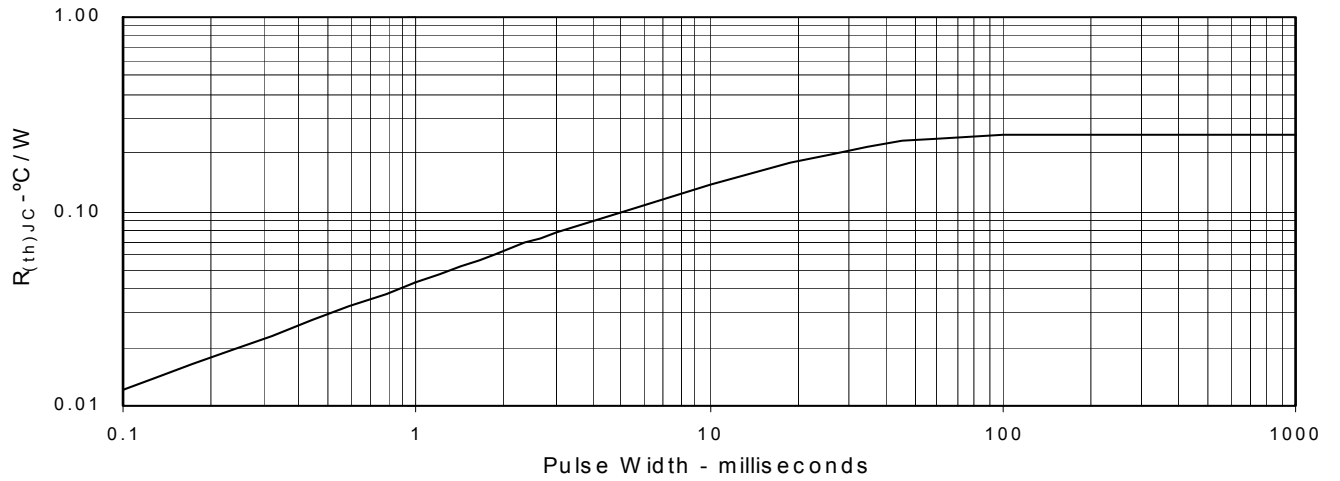

Fig. 13. Maximum Transient Thermal Resistance





---

Disclaimer Notice - Information furnished is believed to be accurate and reliable. However, users should independently evaluate the suitability of and test each product selected for their own applications. Littelfuse products are not designed for, and may not be used in, all applications. Read complete Disclaimer Notice at [www.littelfuse.com/disclaimer-electronics](http://www.littelfuse.com/disclaimer-electronics).