

Depletion Mode MOSFET

IXTT2N170D2 IXTH2N170D2

$V_{DSX} = 1700V$
 $I_{D(on)} \geq 2A$
 $R_{DS(on)} \leq 6.5\Omega$

N-Channel



TO-268 (IXTT)

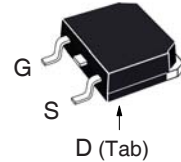

TO-247 (IXTH)

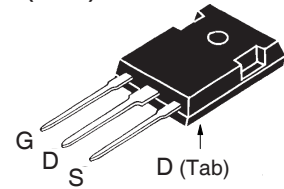

G = Gate D = Drain
 S = Source Tab = Drain

Symbol	Test Conditions	Maximum Ratings	
V_{DSX}	$T_J = 25^\circ C$ to $150^\circ C$	1700	V
V_{DGX}	$T_J = 25^\circ C$ to $150^\circ C$, $R_{GS} = 1M\Omega$	1700	V
V_{GSX}	Continuous	± 20	V
V_{GSM}	Transient	± 30	V
P_D	$T_C = 25^\circ C$	568	W
T_J		- 55 ... +150	$^\circ C$
T_{JM}		150	$^\circ C$
T_{stg}		- 55 ... +150	$^\circ C$
T_L	1.6mm (0.062 in.) from Case for 10s	300	$^\circ C$
T_{SOLD}	Plastic Body for 10s	260	$^\circ C$
M_d	Mounting Torque (TO-247)	1.13 / 10	Nm/lb.in.
Weight	TO-268	4	g
	TO-247	6	g

Features

- Normally ON Mode
- International Standard Packages
- Molding Epoxies Meet UL 94 V-0 Flammability Classification

Advantages

- Easy to Mount
- Space Savings
- High Power Density

Applications

- Audio Amplifiers
- Start-Up Circuits
- Protection Circuits
- Ramp Generators
- Current Regulators
- Active Loads

Symbol	Test Conditions ($T_J = 25^\circ C$, Unless Otherwise Specified)	Characteristic Values		
		Min.	Typ.	Max.
BV_{DSX}	$V_{GS} = -5V$, $I_D = 250\mu A$	1700		V
$V_{GS(off)}$	$V_{DS} = 25V$, $I_D = 250\mu A$	- 2.5		- 4.5 V
I_{GSX}	$V_{GS} = \pm 20V$, $V_{DS} = 0V$			± 100 nA
$I_{DSX(off)}$	$V_{DS} = V_{DSX}$, $V_{GS} = -5V$ $T_J = 125^\circ C$			25 μA 500 μA
$R_{DS(on)}$	$V_{GS} = 0V$, $I_D = 1A$, Note 1			6.5 Ω
$I_{D(on)}$	$V_{GS} = 0V$, $V_{DS} = 50V$, Note 1	2		A

Symbol	Test Conditions ($T_J = 25^\circ\text{C}$, Unless Otherwise Specified)	Characteristic Values		
		Min.	Typ.	Max.
g_{fs}	$V_{DS} = 30\text{V}$, $I_D = 1\text{A}$, Note 1	1.4	2.2	S
C_{iss}	$V_{GS} = -10\text{V}$, $V_{DS} = 25\text{V}$, $f = 1\text{MHz}$		3650	pF
C_{oss}			206	pF
C_{rss}			80	pF
$t_{d(on)}$	Resistive Switching Times $V_{GS} = \pm 5\text{V}$, $V_{DS} = 850\text{V}$, $I_D = 1\text{A}$ $R_G = 2\Omega$ (External)		28	ns
t_r			58	ns
$t_{d(off)}$			33	ns
t_f			106	ns
$Q_{g(on)}$	$V_{GS} = \pm 5\text{V}$, $V_{DS} = 850\text{V}$, $I_D = 1\text{A}$		110	nC
Q_{gs}			12	nC
Q_{gd}			60	nC
R_{thJC}	TO-247			0.22 $^\circ\text{C/W}$
R_{thCS}			0.21	$^\circ\text{C/W}$

Safe-Operating-Area Specification

Symbol	Test Conditions	Characteristic Values		
		Min.	Typ.	Max.
SOA	$V_{DS} = 1700\text{V}$, $I_D = 120\text{mA}$, $T_C = 75^\circ\text{C}$, $T_p = 5\text{s}$	204		W

Source-Drain Diode

Symbol	Test Conditions ($T_J = 25^\circ\text{C}$, Unless Otherwise Specified)	Characteristic Values		
		Min.	Typ.	Max.
V_{SD}	$I_F = 2\text{A}$, $V_{GS} = -10\text{V}$, Note 1		0.75	1.30 V
t_{rr}	$I_F = 2\text{A}$, $-di/dt = 100\text{A}/\mu\text{s}$ $V_R = 100\text{V}$, $V_{GS} = -10\text{V}$		2.8	μs
I_{RM}			45.0	A
Q_{RM}			63.0	μC

Note 1. Pulse test, $t \leq 300\mu\text{s}$, duty cycle, $d \leq 2\%$.

TO-268 Outline

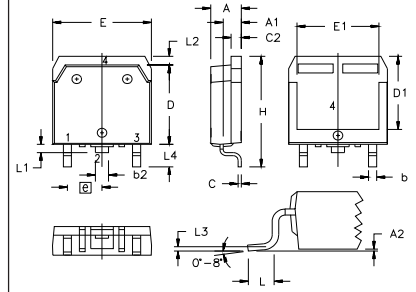

Terminals: 1 - Gate, 2,4 - Drain, 3 - Source

SYM	INCHES		MILLIMETERS	
	MIN	MAX	MIN	MAX
A	.193	.201	4.90	5.10
A1	.106	.114	2.70	2.90
A2	.001	.010	0.02	0.25
b	.045	.057	1.15	1.45
b2	.075	.083	1.90	2.10
C	.016	.026	0.40	0.65
C2	.057	.063	1.45	1.60
D	.543	.551	13.80	14.00
D1	.488	.500	12.40	12.70
E	.624	.632	15.85	16.05
E1	.524	.535	13.30	13.60
e	.215 BSC		5.45 BSC	
H	.736	.752	18.70	19.10
L	.094	.106	2.40	2.70
L1	.047	.055	1.20	1.40
L2	.039	.045	1.00	1.15
L3	.010 BSC		0.25 BSC	
L4	.150	.161	3.80	4.10

TO-247 Outline

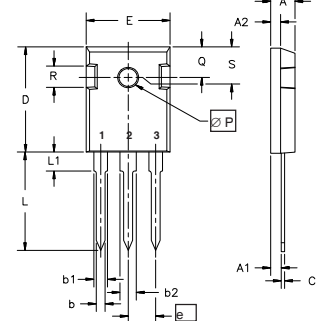

Terminals: 1 - Gate, 2 - Drain, 3 - Source

Dim.	Millimeter		Inches	
	Min.	Max.	Min.	Max.
A	4.7	5.3	.185	.209
A ₁	2.2	2.54	.087	.102
A ₂	2.2	2.6	.059	.098
b	1.0	1.4	.040	.055
b ₁	1.65	2.13	.065	.084
b ₂	2.87	3.12	.113	.123
C	.4	.8	.016	.031
D	20.80	21.46	.819	.845
E	15.75	16.26	.610	.640
e	5.20	5.72	0.205	0.225
L	19.81	20.32	.780	.800
L1		4.50		.177
∅P	3.55	3.65	.140	.144
Q	5.89	6.40	0.232	0.252
R	4.32	5.49	.170	.216
S		6.15 BSC		242 BSC

IXYS Reserves the Right to Change Limits, Test Conditions, and Dimensions.

IXYS MOSFETs and IGBTs are covered by one or more of the following U.S. patents:

4,835,592	4,931,844	5,049,961	5,237,481	6,162,665	6,404,065 B1	6,683,344	6,727,585	7,005,734 B2	7,157,338B2
4,860,072	5,017,508	5,063,307	5,381,025	6,259,123 B1	6,534,343	6,710,405 B2	6,759,692	7,063,975 B2	
4,881,106	5,034,796	5,187,117	5,486,715	6,306,728 B1	6,583,505	6,710,463	6,771,478 B2	7,071,537	

Fig. 1. Output Characteristics @ $T_J = 25^\circ\text{C}$

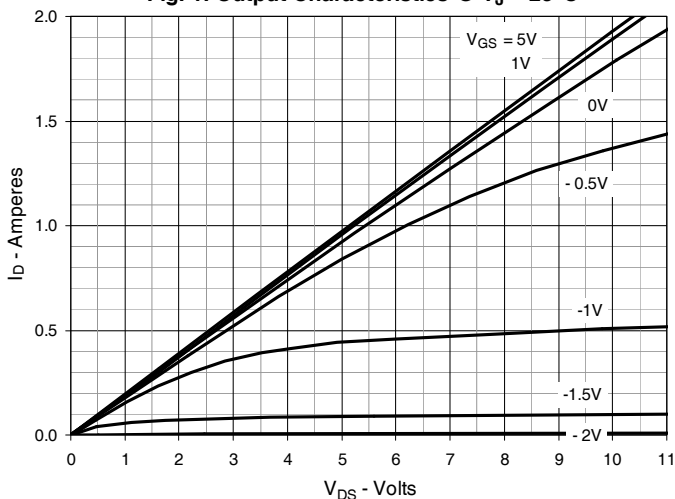

Fig. 2. Extended Output Characteristics @ $T_J = 25^\circ\text{C}$

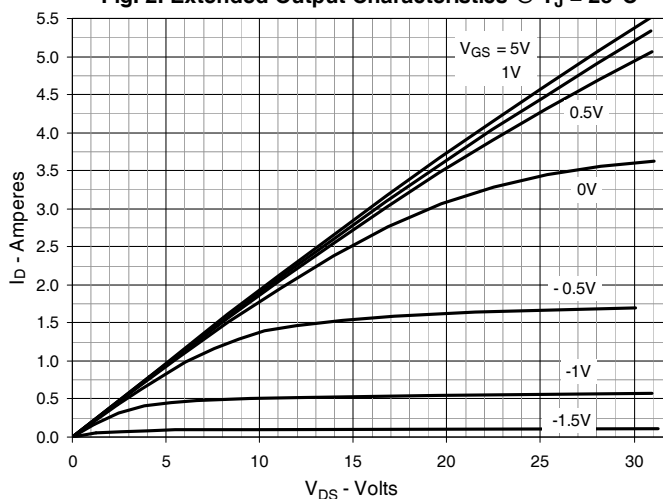

Fig. 3. Output Characteristics @ $T_J = 125^\circ\text{C}$

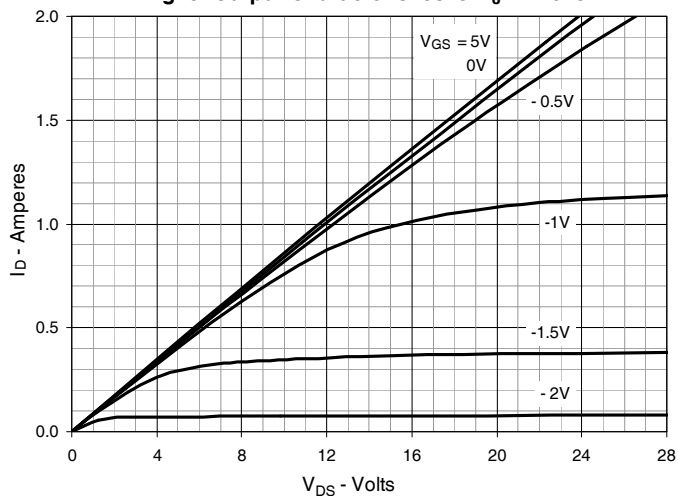

Fig. 4. Drain Current @ $T_J = 25^\circ\text{C}$

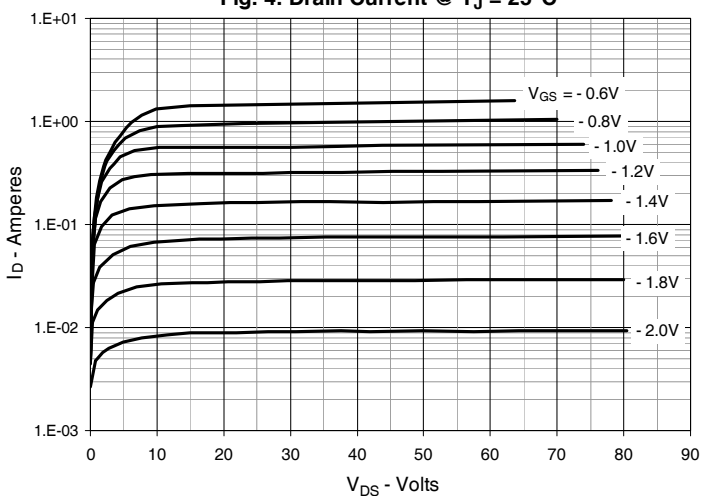

Fig. 5. Drain Current @ $T_J = 100^\circ\text{C}$

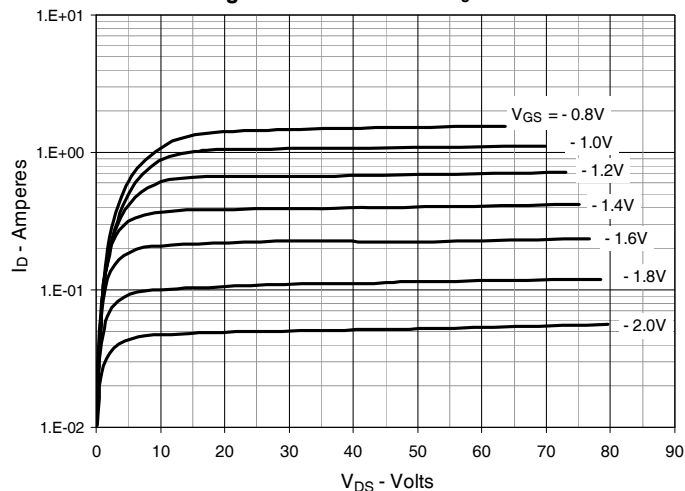

Fig. 6. Dynamic Resistance vs. Gate Voltage

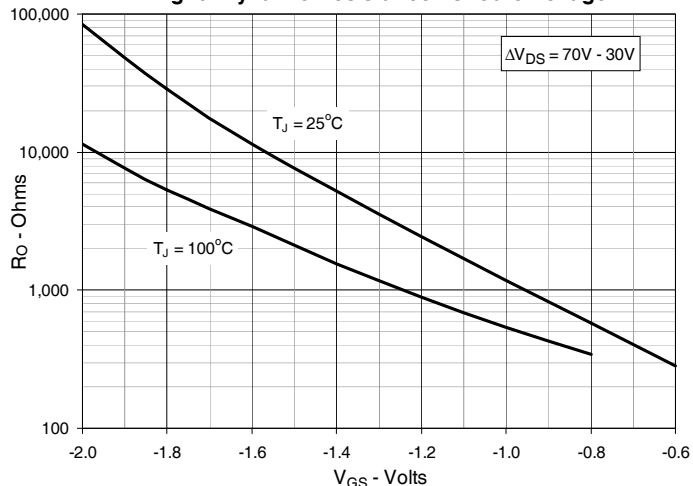

Fig. 7. Dynamic Resistance vs. Gate Voltage

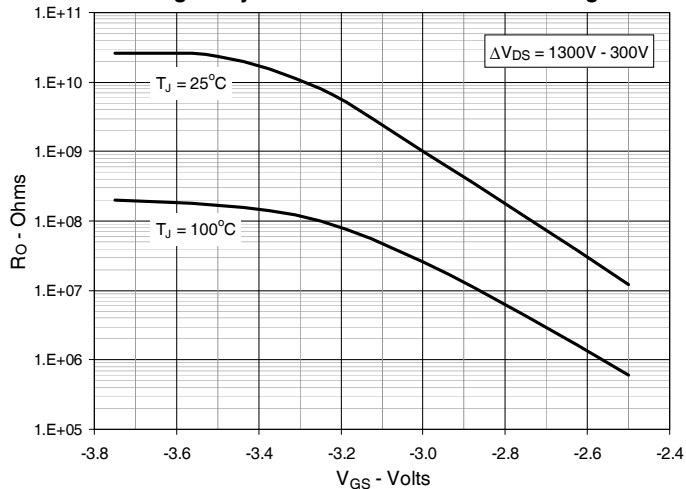

Fig. 8. Normalized $R_{DS(on)}$ vs. Junction Temperature

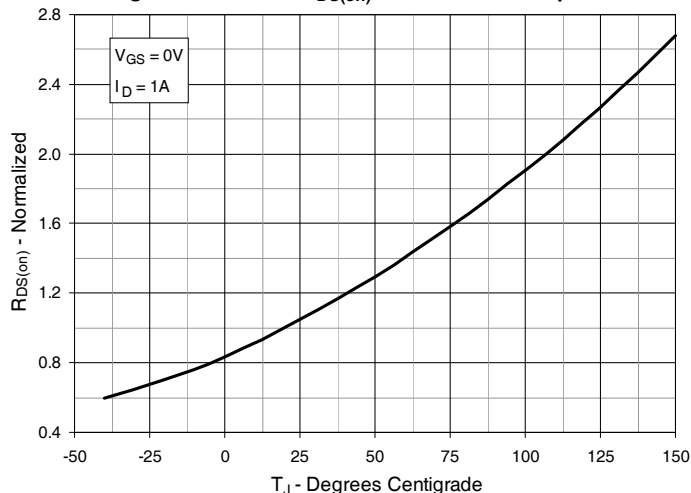

Fig. 9. $R_{DS(on)}$ Normalized to $I_D = 1A$ Value vs. Drain Current

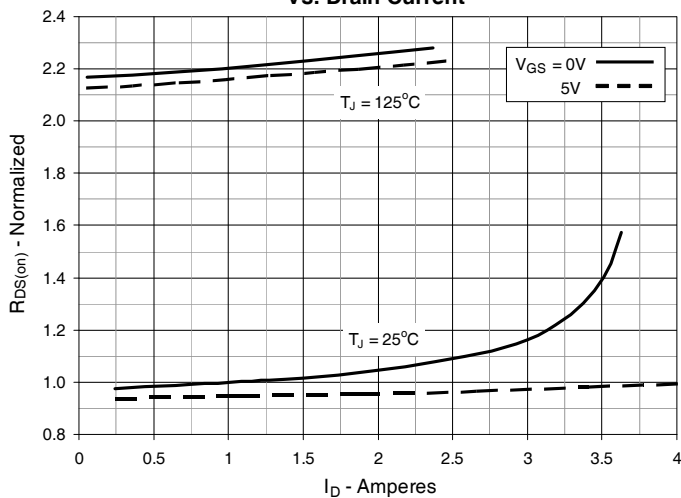

Fig. 10. Input Admittance

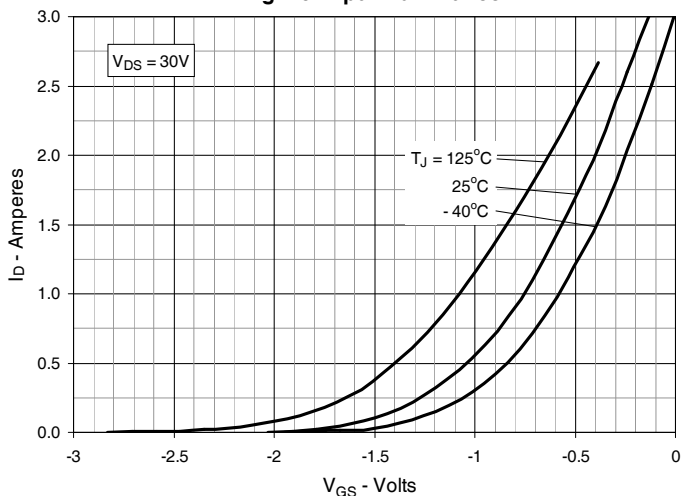

Fig. 11. Transconductance

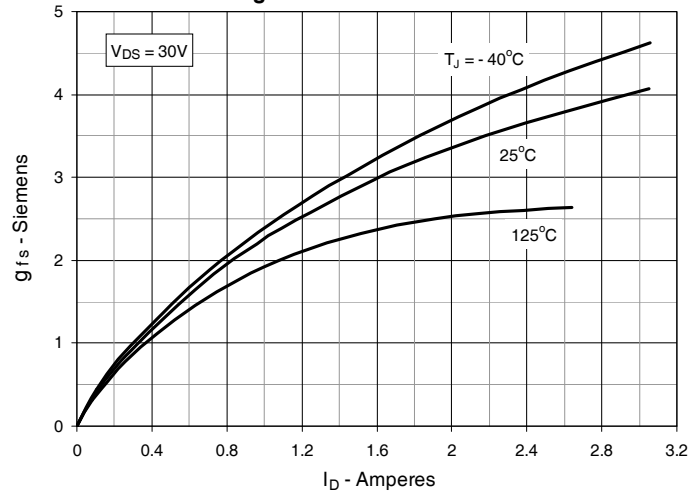

Fig. 12. Normalized Breakdown and Threshold Voltages vs. Junction Temperature

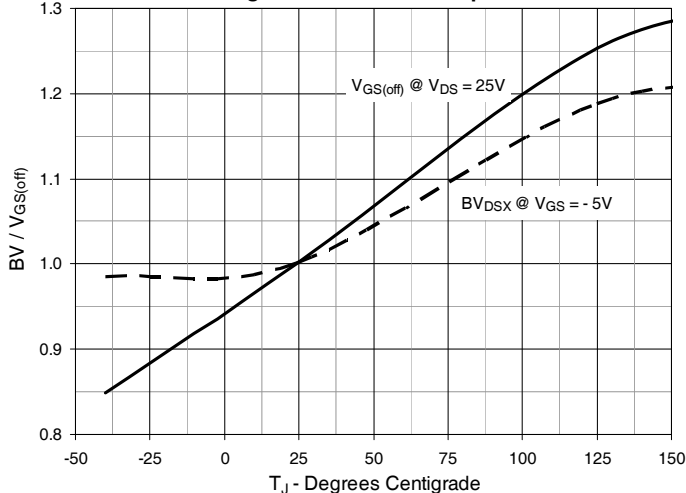

Fig. 13. Forward Voltage Drop of Intrinsic Diode

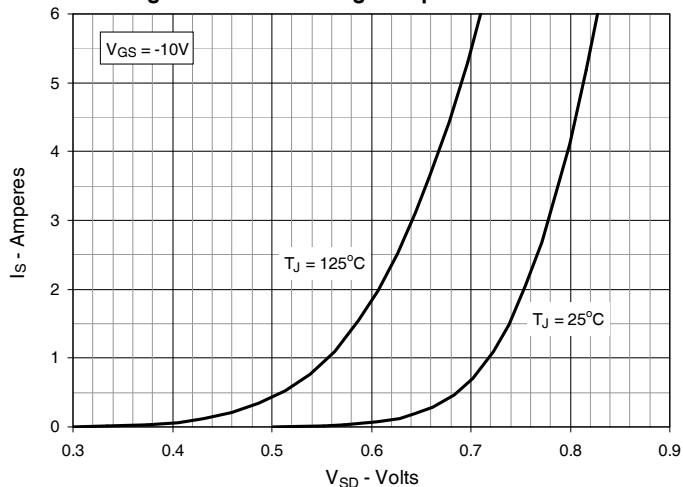

Fig. 14. Capacitance

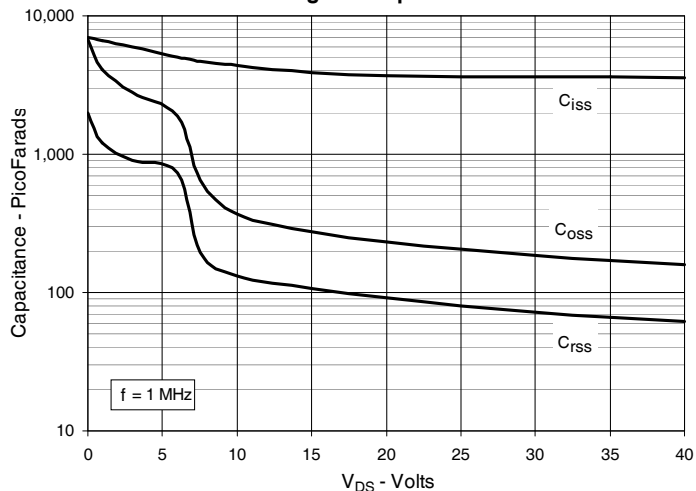

Fig. 15. Gate Charge

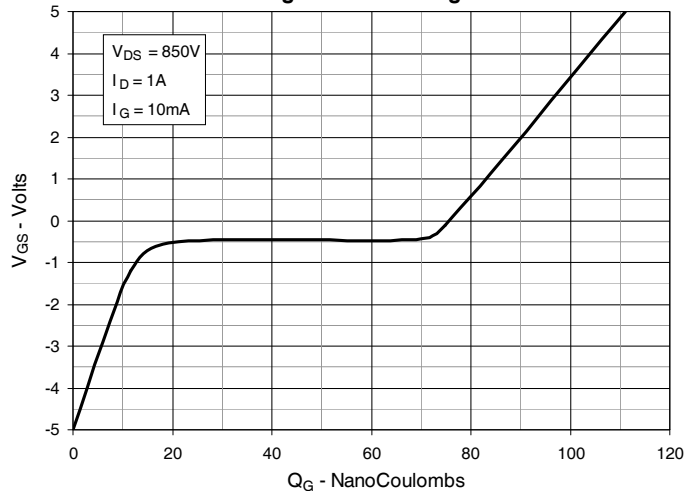

Fig. 16. Maximum Transient Thermal Impedance

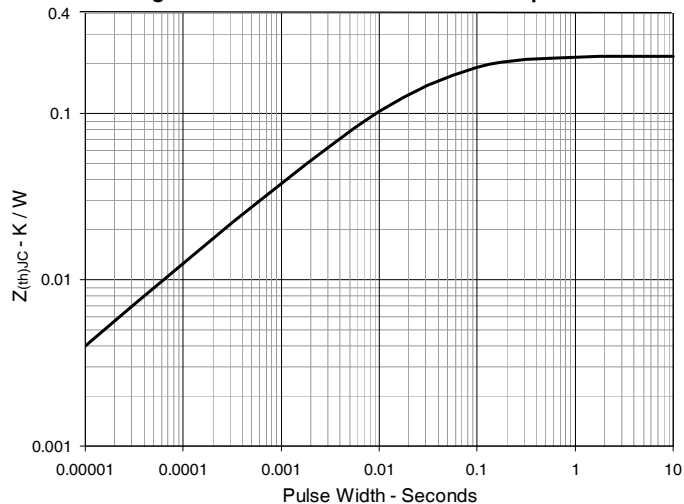

Fig. 17. Forward-Bias Safe Operating Area @ $T_C = 25^\circ\text{C}$

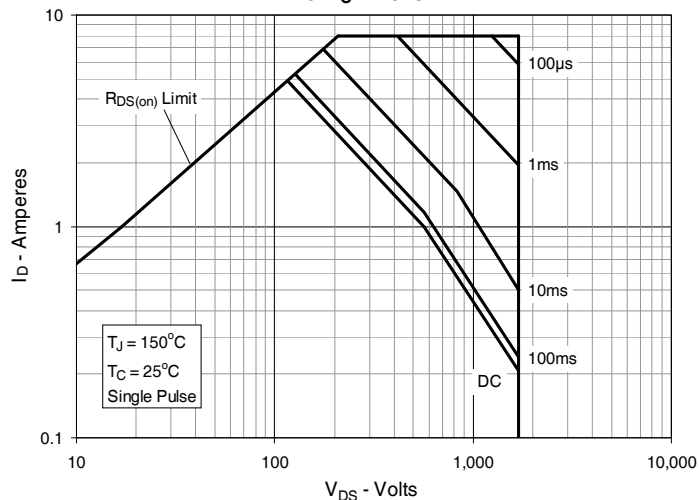
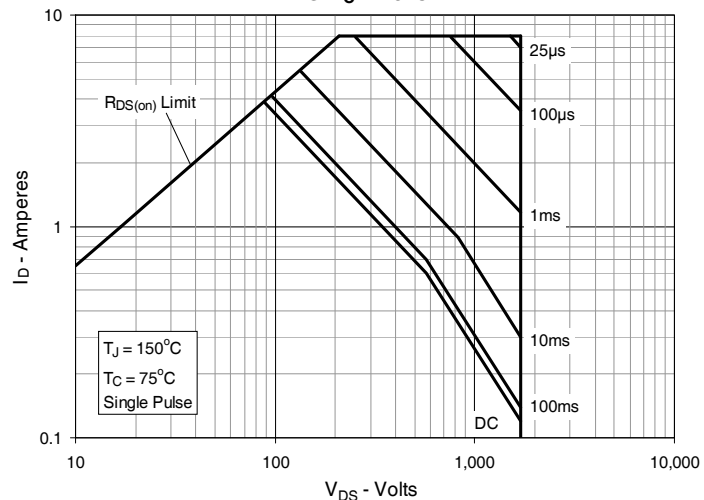

Fig. 18. Forward-Bias Safe Operating Area @ $T_C = 75^\circ\text{C}$





Disclaimer Notice - Information furnished is believed to be accurate and reliable. However, users should independently evaluate the suitability of and test each product selected for their own applications. Littelfuse products are not designed for, and may not be used in, all applications. Read complete Disclaimer Notice at www.littelfuse.com/disclaimer-electronics.