

## Depletion Mode MOSFET

**IXTY1R6N50D2**  
**IXTA1R6N50D2**  
**IXTP1R6N50D2**

$V_{DSX} = 500V$   
 $I_{D(on)} \geq 1.6A$   
 $R_{DS(on)} \leq 2.3\Omega$

### N-Channel

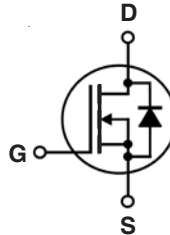

Symbol	Test Conditions	Maximum Ratings	
$V_{DSX}$	$T_J = 25^\circ C$ to $150^\circ C$	500	V
$V_{GSX}$	Continuous	$\pm 20$	V
$V_{GSM}$	Transient	$\pm 30$	V
$P_D$	$T_C = 25^\circ C$	100	W
$T_J$		- 55 ... +150	$^\circ C$
$T_{JM}$		150	$^\circ C$
$T_{stg}$		- 55 ... +150	$^\circ C$
$T_L$	Maximum Lead Temperature for Soldering	300	$^\circ C$
$T_{SOLD}$	1.6 mm (0.062in.) from Case for 10s	260	$^\circ C$
$M_d$	Mounting Torque (TO-220)	1.13 / 10	Nm/lb.in.
Weight	TO-252	0.35	g
	TO-263	2.50	g
	TO-220	3.00	g

Symbol	Test Conditions ( $T_J = 25^\circ C$ , Unless Otherwise Specified)	Characteristic Values		
		Min.	Typ.	Max.
$BV_{DSX}$	$V_{GS} = -5V, I_D = 250\mu A$	500		V
$V_{GS(off)}$	$V_{DS} = 25V, I_D = 100\mu A$	- 2.5		V
$I_{GSX}$	$V_{GS} = \pm 20V, V_{DS} = 0V$			$\pm 100$ nA
$I_{DSX(off)}$	$V_{DS} = V_{DSX}, V_{GS} = -5V$ $T_J = 125^\circ C$			2 $\mu A$ 25 $\mu A$
$R_{DS(on)}$	$V_{GS} = 0V, I_D = 0.8A, \text{ Note 1}$			2.3 $\Omega$
$I_{D(on)}$	$V_{GS} = 0V, V_{DS} = 25V, \text{ Note 1}$	1.6		A

TO-252 (IXTY)

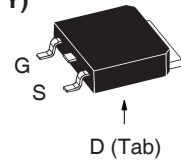

TO-263 (IXTA)

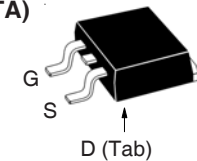

TO-220 (IXTP)

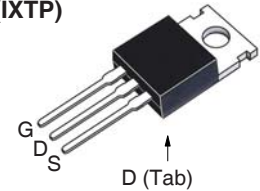

G = Gate      D = Drain  
S = Source    Tab = Drain

### Features

- Normally ON Mode
- International Standard Packages
- Molding Epoxies Meet UL94 V-0 Flammability Classification

### Advantages

- Easy to Mount
- Space Savings
- High Power Density

### Applications

- Audio Amplifiers
- Start-up Circuits
- Protection Circuits
- Ramp Generators
- Current Regulators
- Active Loads

Symbol	Test Conditions ( $T_J = 25^\circ\text{C}$ , Unless Otherwise Specified)	Characteristic Values		
		Min.	Typ.	Max.
$g_{fs}$	$V_{DS} = 30\text{V}, I_D = 0.8\text{A}$ , Note 1	1.00	1.75	S
$C_{iss}$	$V_{GS} = -10\text{V}, V_{DS} = 25\text{V}, f = 1\text{MHz}$		645	pF
$C_{oss}$			65	pF
$C_{rss}$			16.5	pF
$t_{d(on)}$	<b>Resistive Switching Times</b> $V_{GS} = \pm 5\text{V}, V_{DS} = 250\text{V}, I_D = 0.8\text{A}$ $R_G = 5\Omega$ (External)		25	ns
$t_r$			70	ns
$t_{d(off)}$			35	ns
$t_f$			41	ns
$Q_{g(on)}$	$V_{GS} = 5\text{V}, V_{DS} = 250\text{V}, I_D = 0.8\text{A}$		23.7	nC
$Q_{gs}$			2.2	nC
$Q_{gd}$			13.8	nC
$R_{thJC}$	TO-220			1.25 $^\circ\text{C/W}$
$R_{thCS}$			0.50	$^\circ\text{C/W}$

**Safe-Operating-Area Specification**

Symbol	Test Conditions	Characteristic Values		
		Min.	Typ.	Max.
SOA	$V_{DS} = 400\text{V}, I_D = 0.15\text{A}, T_C = 75^\circ\text{C}, T_p = 5\text{s}$	60		W

**Source-Drain Diode**

Symbol	Test Conditions ( $T_J = 25^\circ\text{C}$ , Unless Otherwise Specified)	Characteristic Values		
		Min.	Typ.	Max.
$V_{SD}$	$I_F = 1.6\text{A}, V_{GS} = -10\text{V}$ , Note 1		0.8	1.3 V
$t_{rr}$	$I_F = 1.6\text{A}, -di/dt = 100\text{A}/\mu\text{s}$ $V_R = 100\text{V}, V_{GS} = -10\text{V}$		400	ns
$I_{RM}$			9.16	A
$Q_{RM}$			1.83	$\mu\text{C}$

Note 1. Pulse test,  $t \leq 300\mu\text{s}$ , duty cycle,  $d \leq 2\%$ .

IXYS Reserves the Right to Change Limits, Test Conditions, and Dimensions.

IXYS MOSFETs and IGBTs are covered by one or more of the following U.S. patents:

4,835,592	4,931,844	5,049,961	5,237,481	6,162,665	6,404,065 B1	6,683,344	6,727,585	7,005,734 B2	7,157,338B2
4,860,072	5,017,508	5,063,307	5,381,025	6,259,123 B1	6,534,343	6,710,405 B2	6,759,692	7,063,975 B2	
4,881,106	5,034,796	5,187,117	5,486,715	6,306,728 B1	6,583,505	6,710,463	6,771,478 B2	7,071,537	

Fig. 1. Output Characteristics @  $T_J = 25^\circ\text{C}$

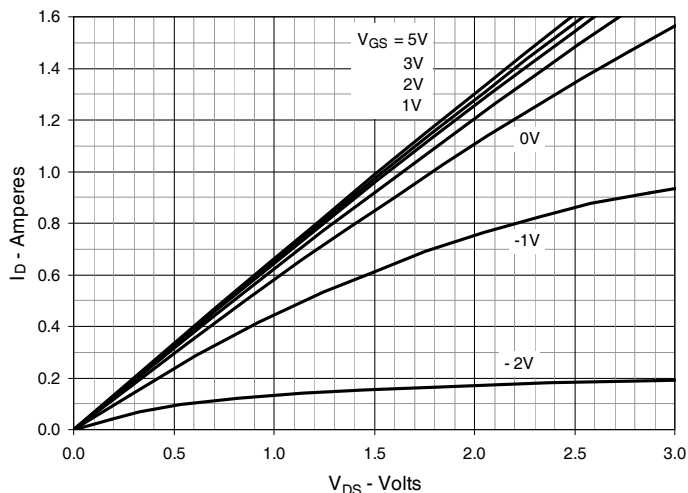

Fig. 2. Extended Output Characteristics @  $T_J = 25^\circ\text{C}$

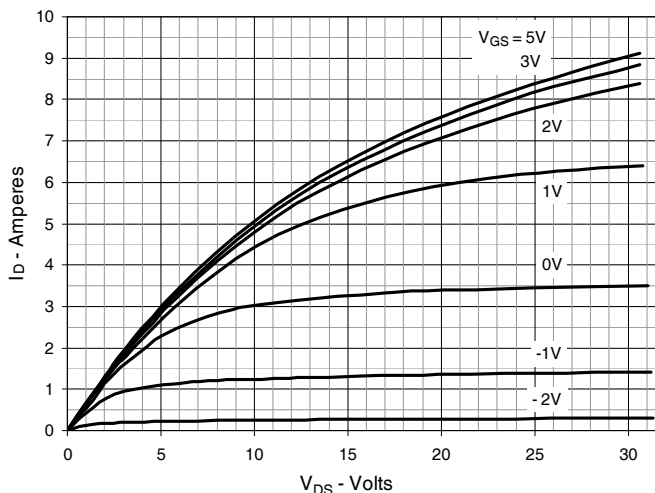

Fig. 3. Output Characteristics @  $T_J = 125^\circ\text{C}$

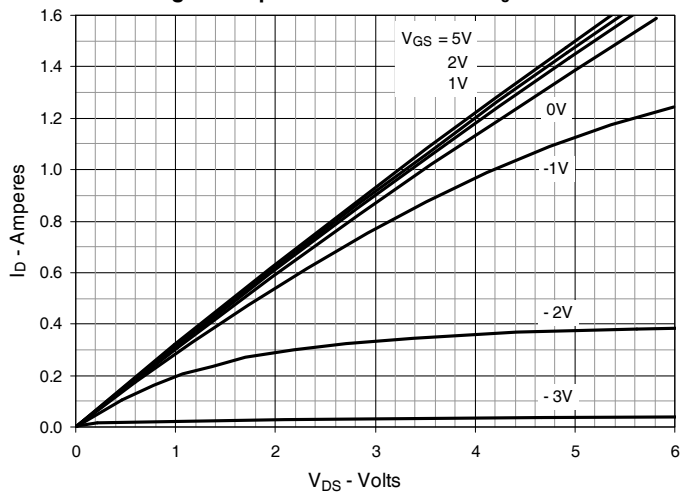

Fig. 4. Drain Current @  $T_J = 25^\circ\text{C}$

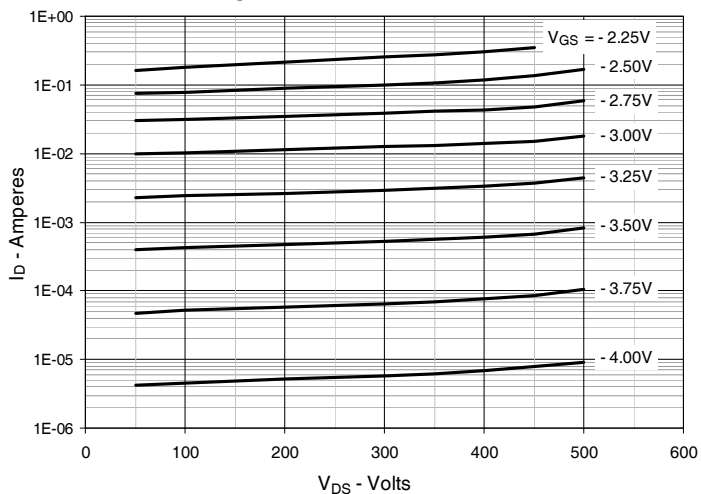

Fig. 5. Drain Current @  $T_J = 100^\circ\text{C}$

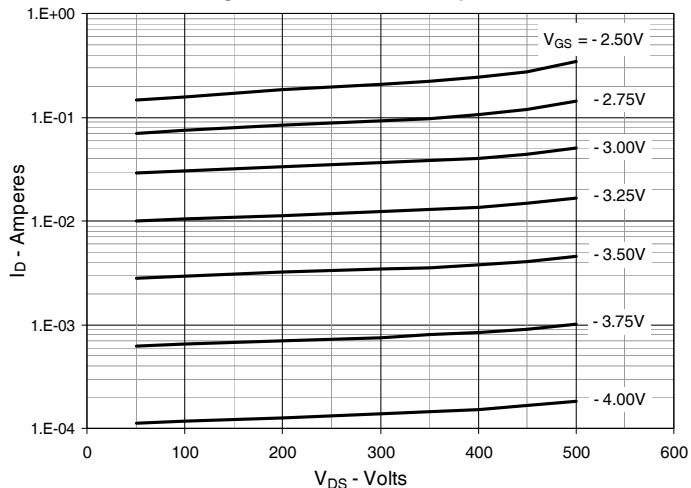
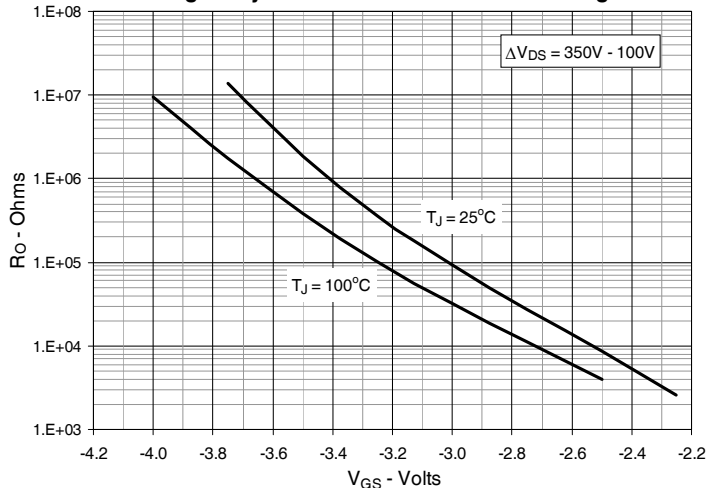
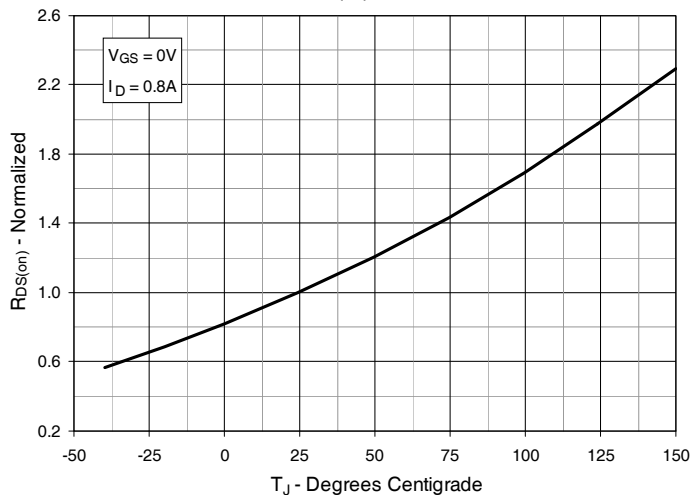

Fig. 6. Dynamic Resistance vs. Gate Voltage



**Fig. 7. Normalized  $R_{DS(on)}$  vs. Junction Temperature**



**Fig. 8.  $R_{DS(on)}$  Normalized to  $I_D = 0.8A$  Value vs. Drain Current**

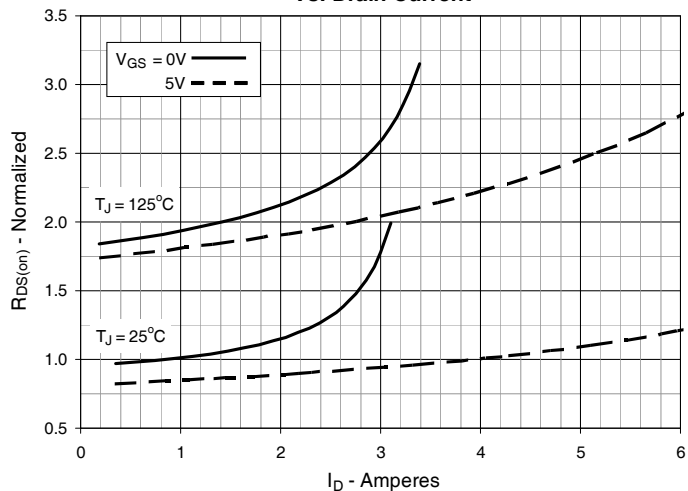

**Fig. 9. Input Admittance**

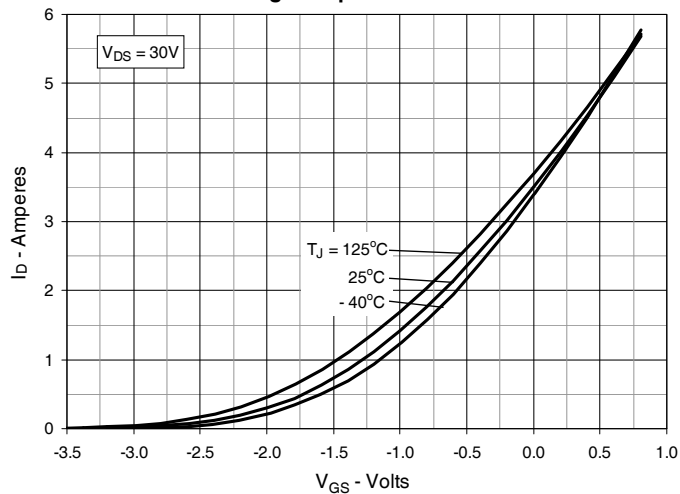

**Fig. 10. Transconductance**

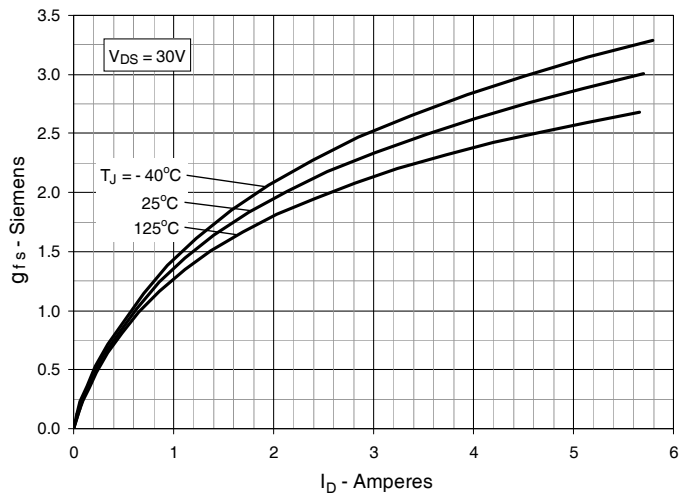

**Fig. 11. Breakdown and Threshold Voltages vs. Junction Temperature**

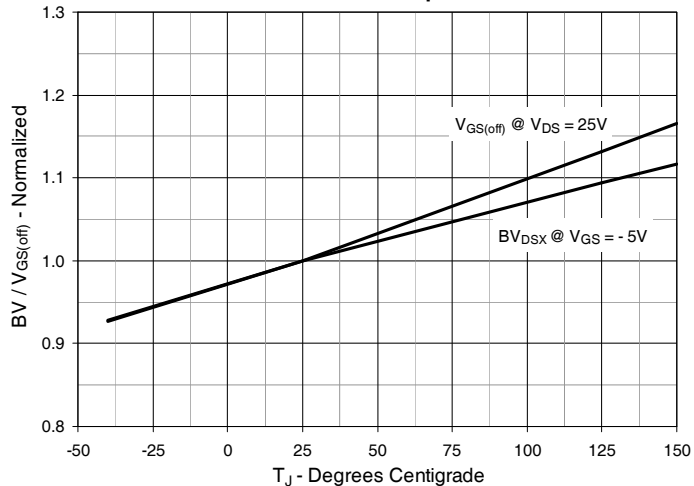

**Fig. 12. Forward Voltage Drop of Intrinsic Diode**

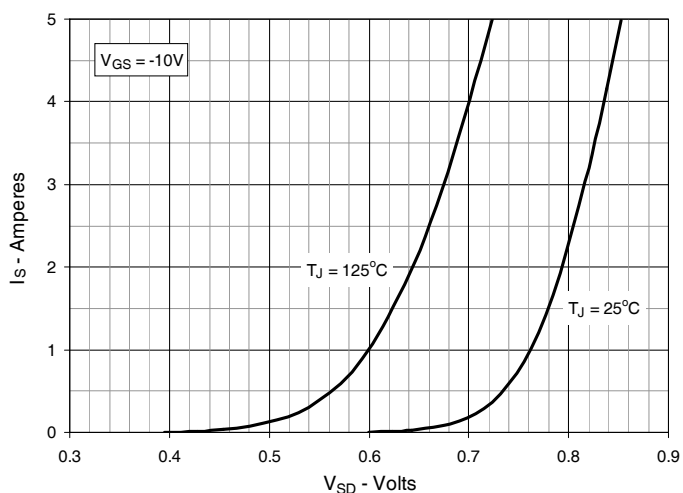

Fig. 13. Capacitance

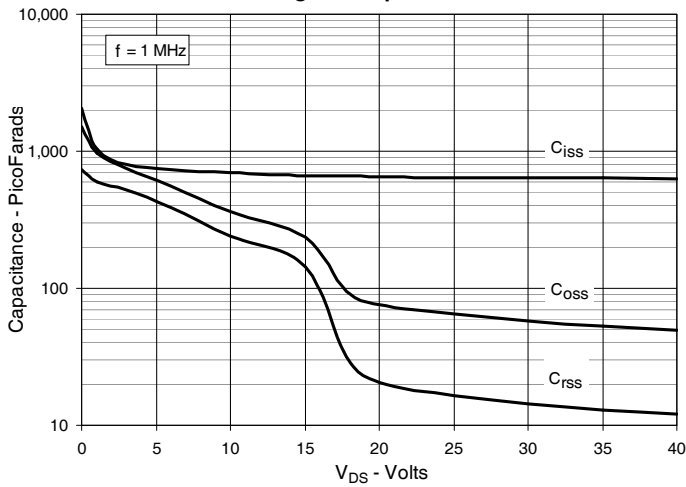

Fig. 14. Gate Charge

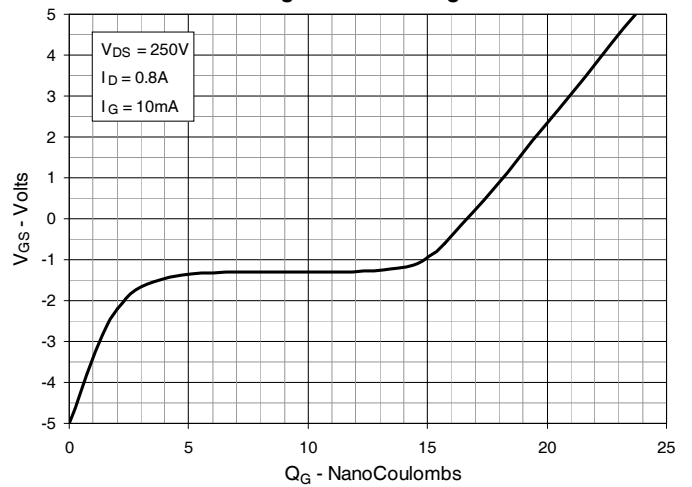

Fig. 15. Forward-Bias Safe Operating Area  
@  $T_C = 25^\circ\text{C}$

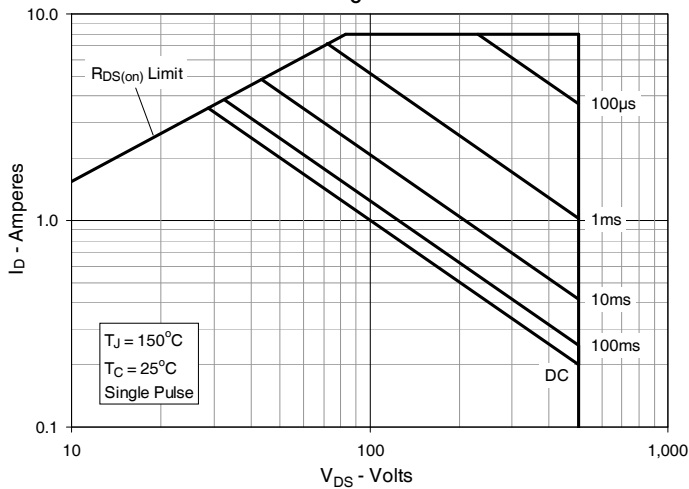

Fig. 16. Forward-Bias Safe Operating Area  
@  $T_C = 75^\circ\text{C}$

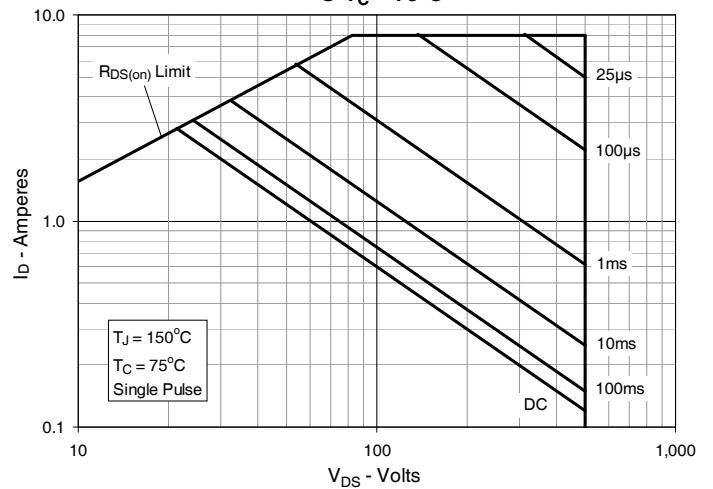
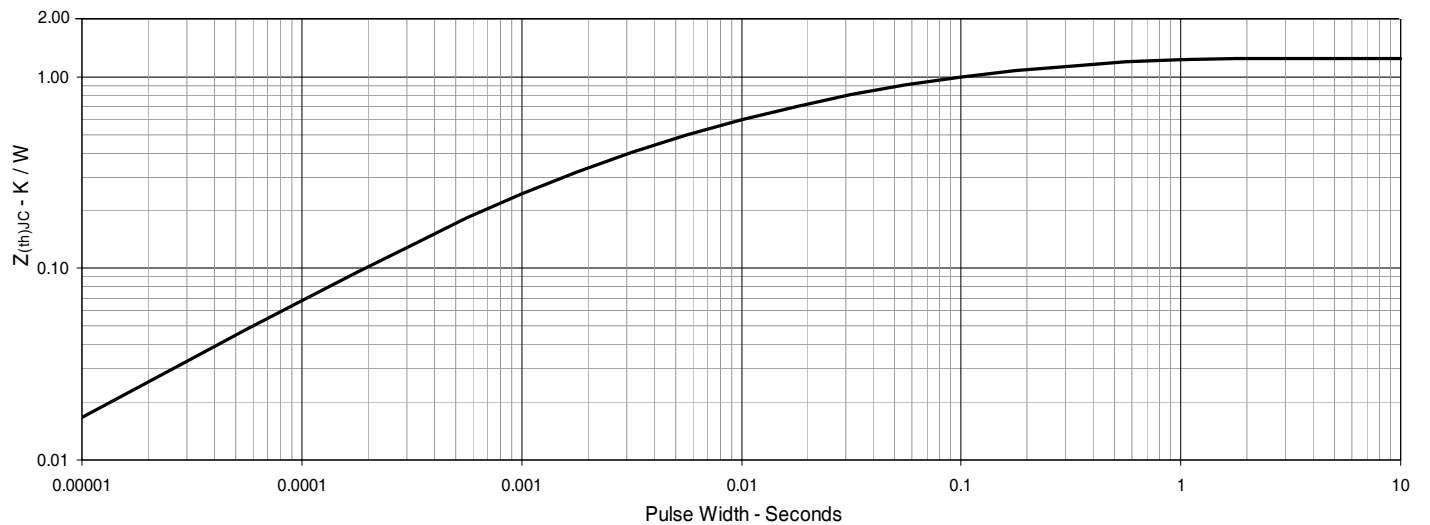
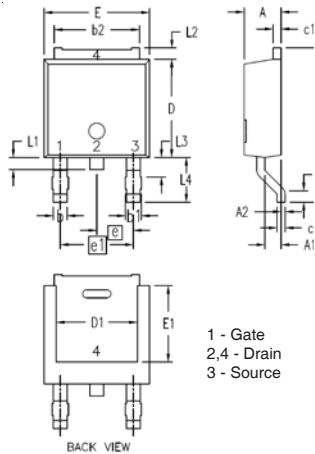
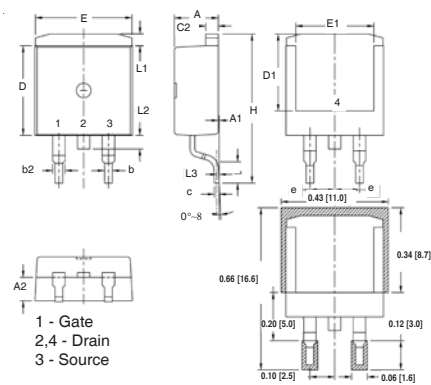

Fig. 17. Maximum Transient Thermal Resistance



**TO-252 Outline**

SYM	INCHES		MILLIMETERS	
	MIN	MAX	MIN	MAX
A	.086	.094	2.19	2.38
A1	.035	.045	0.89	1.14
A2	0	.004	0	0.10
b	.025	.035	0.64	0.89
b1	.030	.045	0.76	1.14
b2	.205	.215	5.21	5.46
c	.018	.023	0.46	0.58
c1	.018	.023	0.46	0.58
D	.235	.245	5.97	6.22
D1	.170	.205	4.32	5.21
E	.250	.265	6.35	6.73
E1	.170	.205	4.32	5.21
e	.090 BSC		2.28 BSC	
e1	.180 BSC		4.57 BSC	
H	.370	.410	9.40	10.42
L	.020	.040	0.51	1.02
L1	.025	.040	0.64	1.02
L2	.024	.036	0.60	0.90
L3	.045	.060	1.15	1.52
L4	.100	.115	2.54	2.92

**TO-263 Outline**

SYM	INCHES		MILLIMETER	
	MIN	MAX	MIN	MAX
A	.170	.185	4.30	4.70
A1	.000	.008	0.00	0.20
A2	.091	.098	2.30	2.50
b	.028	.035	0.70	0.90
b2	.046	.060	1.18	1.52
C	.018	.024	0.45	0.60
C2	.049	.060	1.25	1.52
D	.340	.370	8.63	9.40
D1	.300	.327	7.62	8.30
E	.380	.410	9.65	10.41
E1	.270	.330	6.86	8.38
e	.100 BSC		2.54 BSC	
H	.580	.620	14.73	15.75
L	.075	.105	1.91	2.67
L1	.039	.060	1.00	1.52
L2	—	.070	—	1.77
L3	.010 BSC		0.254 BSC	

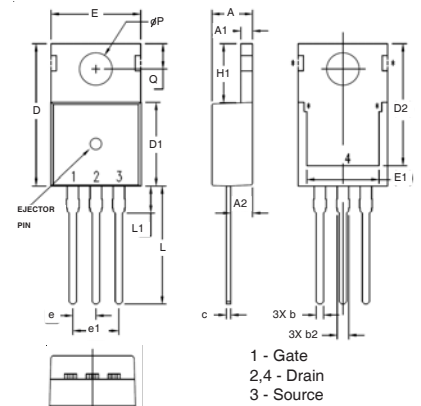
**TO-220 Outline**

SYM	INCHES		MILLIMETERS	
	MIN	MAX	MIN	MAX
A	.169	.185	4.30	4.70
A1	.047	.055	1.20	1.40
A2	.079	.106	2.00	2.70
b	.024	.039	0.60	1.00
b2	.045	.057	1.15	1.45
c	.014	.026	0.35	0.65
D	.587	.626	14.90	15.90
D1	.335	.370	8.50	9.40
(D2)	.500	.531	12.70	13.50
E	.382	.406	9.70	10.30
(E1)	.283	.323	7.20	8.20
e	.100 BSC		2.54 BSC	
e1	.200 BSC		5.08 BSC	
H1	.244	.268	6.20	6.80
L	.492	.547	12.50	13.90
L1	.110	.154	2.80	3.90
∅P	.134	.150	3.40	3.80
Q	.106	.126	2.70	3.20



---

Disclaimer Notice - Information furnished is believed to be accurate and reliable. However, users should independently evaluate the suitability of and test each product selected for their own applications. Littelfuse products are not designed for, and may not be used in, all applications. Read complete Disclaimer Notice at [www.littelfuse.com/disclaimer-electronics](http://www.littelfuse.com/disclaimer-electronics).