

Depletion Mode MOSFET

IXTH10N100D IXTT10N100D

$V_{DSX} = 1000V$
 $I_{D25} = 10A$
 $R_{DS(on)} \leq 1.4\Omega$

N-Channel

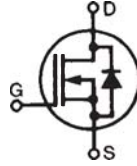

Symbol	Test Conditions	Maximum Ratings	
V_{DSX}	$T_J = 25^\circ C$ to $150^\circ C$	1000	V
V_{DGX}	$T_J = 25^\circ C$ to $150^\circ C$, $R_{GS} = 1M\Omega$	1000	V
V_{GSX}	Continuous	± 30	V
V_{GSM}	Transient	± 40	V
I_{D25}	$T_C = 25^\circ C$	10	A
I_{DM}	$T_C = 25^\circ C$, Pulse Width Limited by T_{JM}	20	A
P_D	$T_C = 25^\circ C$	400	W
T_J		- 55 ... +150	$^\circ C$
T_{JM}		150	$^\circ C$
T_{stg}		- 55 ... +150	$^\circ C$
T_L	Maximum Lead Temperature for Soldering	300	$^\circ C$
T_{SOLD}	1.6 mm (0.062in.) from Case for 10s	260	$^\circ C$
M_d	Mounting Torque (TO-247)	1.13 / 10	Nm/lb.in.
Weight	TO-268	4	g
	TO-247	6	g

TO-268
(IXTT)

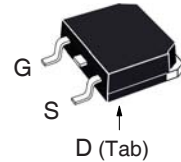

TO-247
(IXTH)

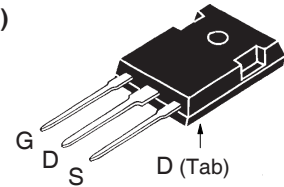

G = Gate D = Drain
S = Source Tab = Drain

Features

- Normally ON Mode
- International Standard Packages
- Molding Epoxies meet UL 94 V-0 Flammability Classification

Advantages

- Easy to Mount
- Space Savings
- High Power Density

Applications

- Level Shifting
- Triggers
- Solid State Relays
- Current Regulators
- Active Load

Symbol	Test Conditions ($T_J = 25^\circ C$, Unless Otherwise Specified)	Characteristic Values		
		Min.	Typ.	Max.
BV_{DSX}	$V_{GS} = -10V$, $I_D = 250\mu A$	1000		V
$V_{GS(off)}$	$V_{DS} = 25V$, $I_D = 250\mu A$	-1.5		V
I_{GSX}	$V_{GS} = \pm 30V$, $V_{DS} = 0V$			± 100 nA
$I_{DSX(off)}$	$V_{DS} = V_{DSX}$, $V_{GS} = -10V$ $T_J = 125^\circ C$			25 μA
				500 μA
$R_{DS(on)}$	$V_{GS} = 10V$, $I_D = 10A$, Note 1			1.4 Ω
$I_{D(on)}$	$V_{GS} = 0V$, $V_{DS} = 25V$, Note 1		1.0	A

Symbol	Test Conditions ($T_J = 25^\circ\text{C}$, Unless Otherwise Specified)	Characteristic Values		
		Min.	Typ.	Max.
g_{fs}	$V_{DS} = 30\text{V}$, $I_D = 0.5 \cdot I_{D25}$, Note 1	3.0	5.4	S
C_{iss}	$V_{GS} = -10\text{V}$, $V_{DS} = 25\text{V}$, $f = 1\text{MHz}$		2500	pF
C_{oss}			300	pF
C_{rss}			100	pF
$t_{d(on)}$	Resistive Switching Times $V_{GS} = -10\text{V}$, $V_{DS} = 0.5 \cdot V_{DSX}$, $I_D = 0.5 \cdot I_{D25}$ $R_G = 4.7\Omega$ (External)		35	ns
t_r			85	ns
$t_{d(off)}$			110	ns
t_f			75	ns
$Q_{g(on)}$	$V_{GS} = 10\text{V}$, $V_{DS} = 0.5 \cdot V_{DSX}$, $I_D = 0.5 \cdot I_{D25}$		130	nC
Q_{gs}			27	nC
Q_{gd}			58	nC
R_{thJC}	TO-247			0.31 $^\circ\text{C/W}$
R_{thCS}			0.21	$^\circ\text{C/W}$

Source-Drain Diode

Symbol	Test Conditions ($T_J = 25^\circ\text{C}$, Unless Otherwise Specified)	Characteristic Values		
		Min.	Typ.	Max.
V_{SD}	$I_F = I_{D25}$, $V_{GS} = -10\text{V}$, Note 1		1.1	1.5 V
t_{rr}	$I_F = 10\text{A}$, $-di/dt = 100\text{A}/\mu\text{s}$ $V_R = 100\text{V}$, $V_{GS} = -10\text{V}$		850	ns

Note 1: Pulse test, $t \leq 300\mu\text{s}$, duty cycle, $d \leq 2\%$.

IXYS Reserves the Right to Change Limits, Test Conditions, and Dimensions.

IXYS MOSFETs and IGBTs are covered by one or more of the following U.S. patents:

4,835,592	4,931,844	5,049,961	5,237,481	6,162,665	6,404,065 B1	6,683,344	6,727,585	7,005,734 B2	7,157,338B2
4,860,072	5,017,508	5,063,307	5,381,025	6,259,123 B1	6,534,343	6,710,405 B2	6,759,692	7,063,975 B2	
4,881,106	5,034,796	5,187,117	5,486,715	6,306,728 B1	6,583,505	6,710,463	6,771,478 B2	7,071,537	

Fig. 1. Output Characteristics @ $T_J = 25^\circ\text{C}$

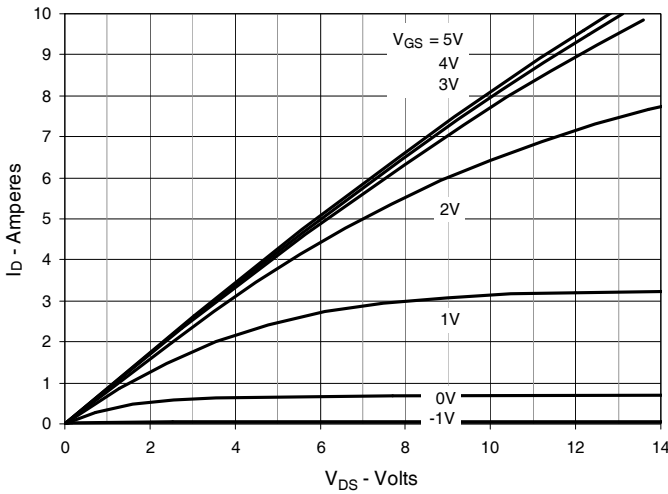

Fig. 2. Extended Output Characteristics @ $T_J = 25^\circ\text{C}$

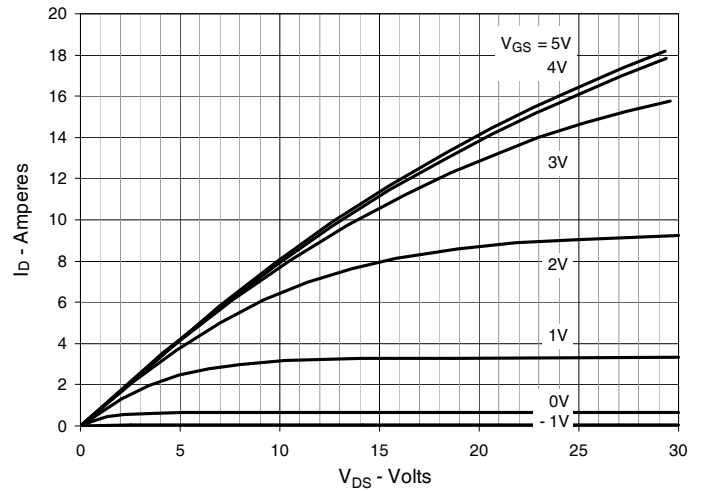

Fig. 3. Output Characteristics @ $T_J = 125^\circ\text{C}$

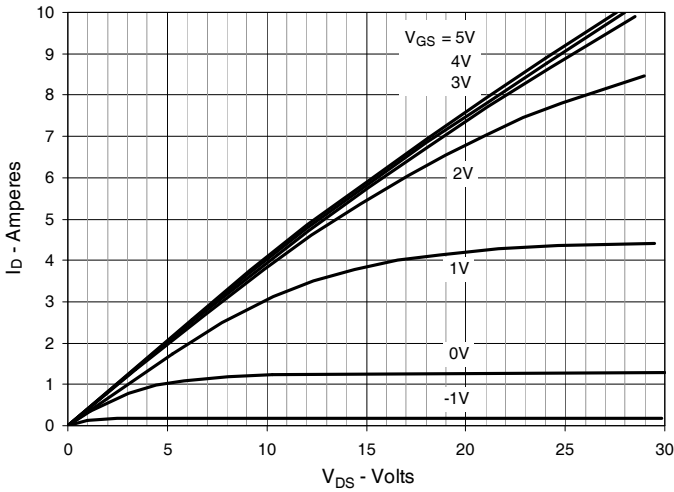

Fig. 4. $R_{DS(on)}$ Normalized to $I_D = 5A$ Value vs. Junction Temperature

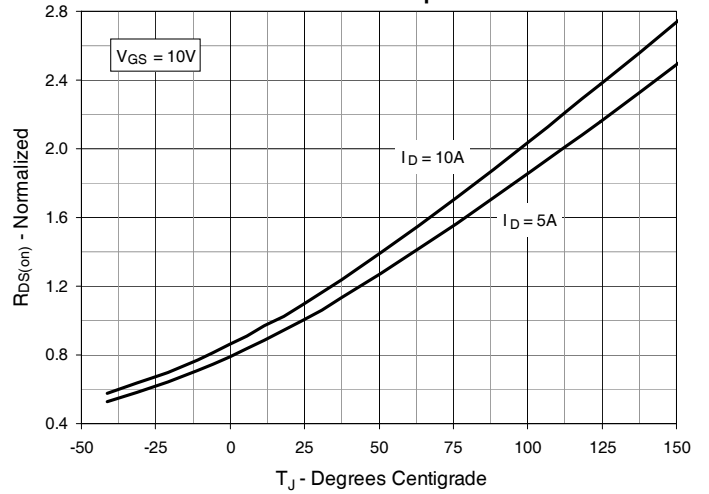

Fig. 5. $R_{DS(on)}$ Normalized to $I_D = 5A$ Value vs. Drain Current

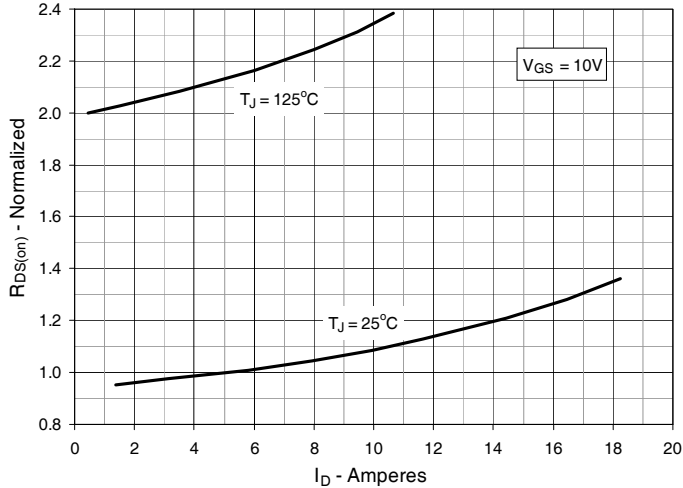

Fig. 6. Maximum Drain Current vs. Case Temperature

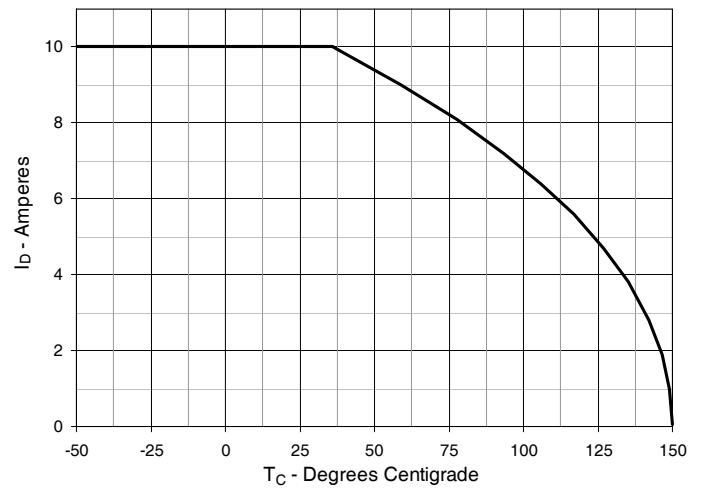

Fig. 7. Input Admittance

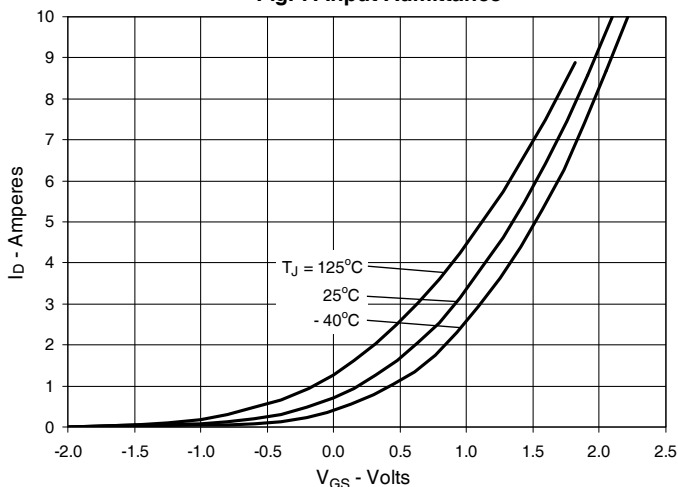

Fig. 8. Transconductance

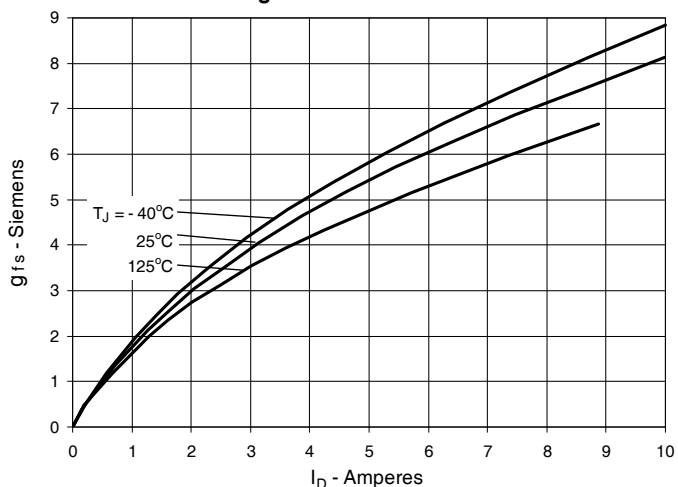

Fig. 9. Forward Voltage Drop of Intrinsic Diode

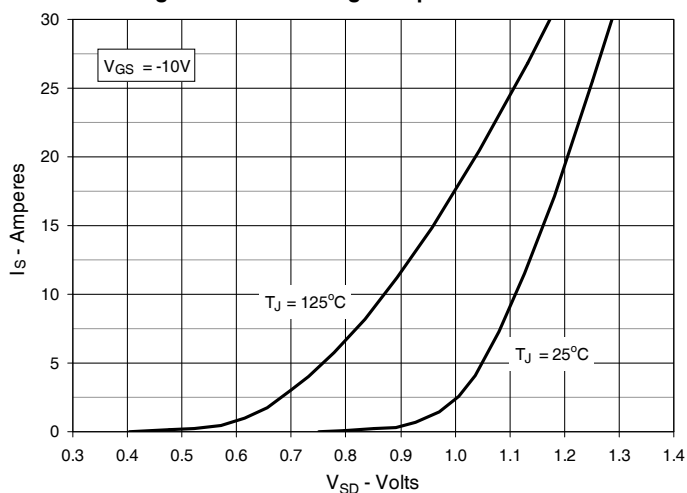

Fig. 10. Breakdown & Threshold Voltages vs. Junction Temperature

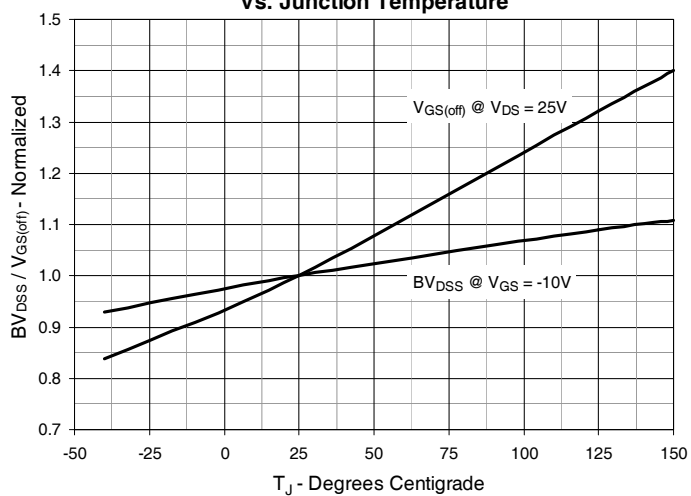

Fig. 11. Gate Charge

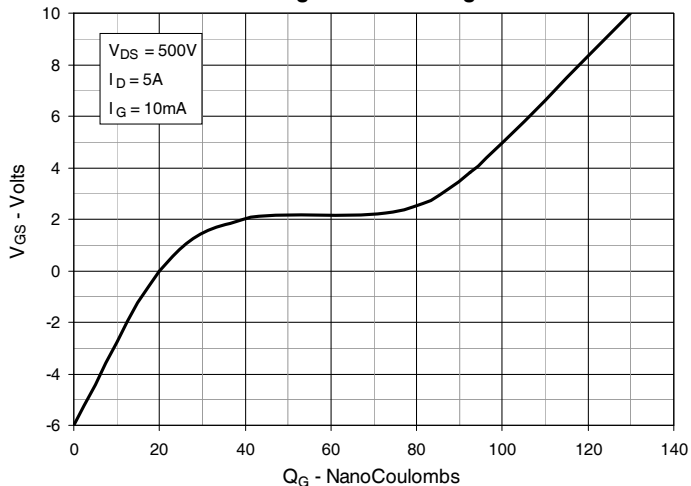

Fig. 12. Capacitance

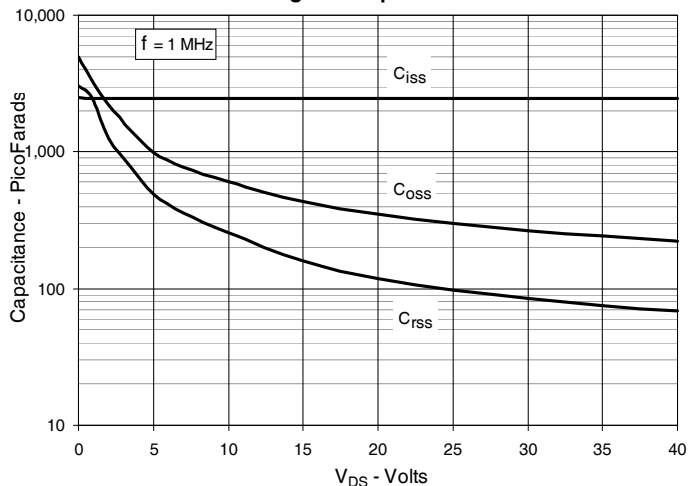

Fig. 13. Forward-Bias Safe Operating Area
@ $T_C = 25^\circ\text{C}$

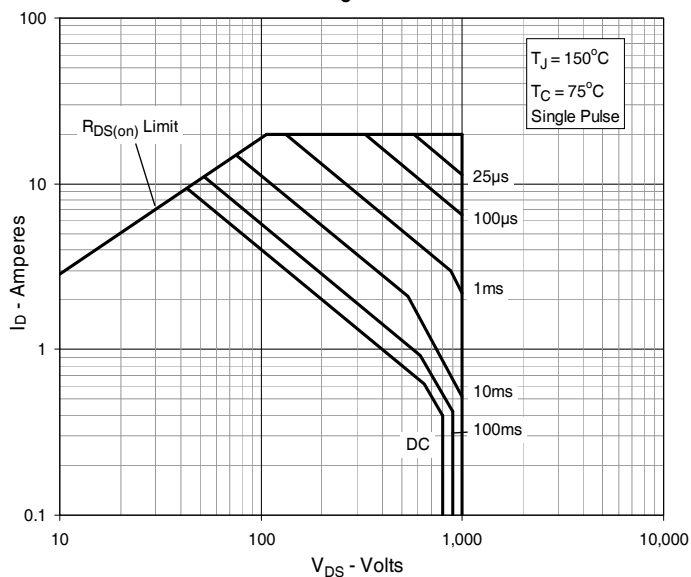

Fig. 14. Forward-Bias Safe Operating Area
@ $T_C = 75^\circ\text{C}$

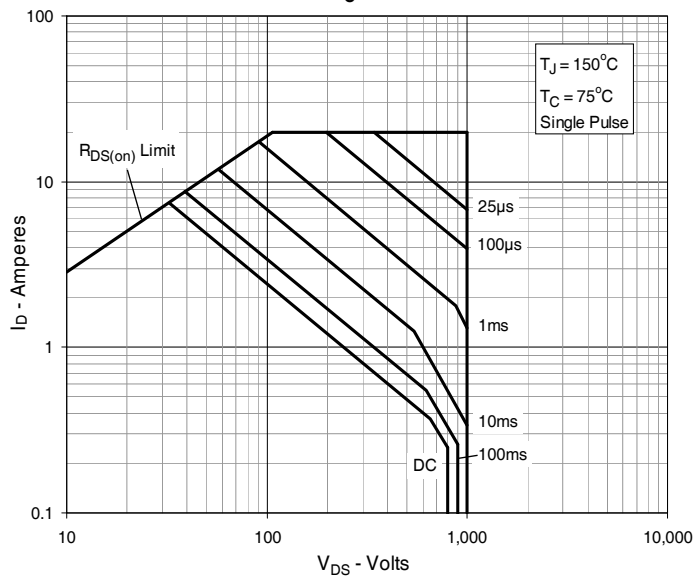
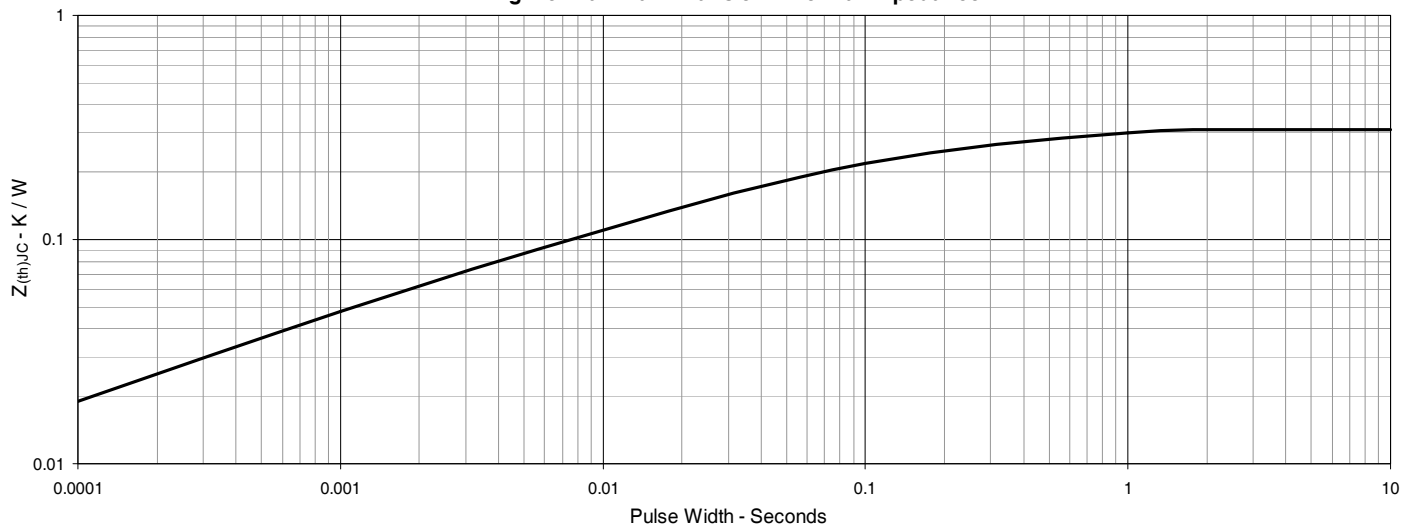
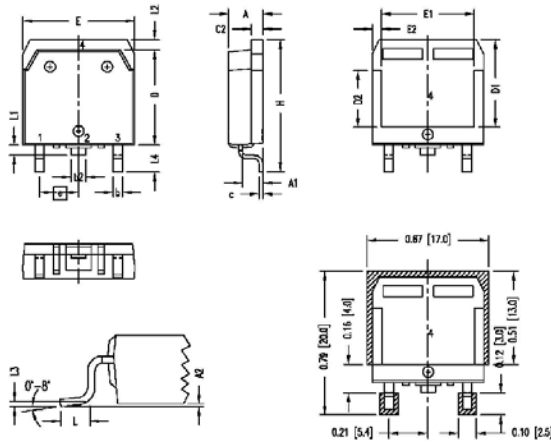

Fig. 15. Maximum Transient Thermal Impedance



TO-268 Outline



- 1 - Gate
- 2,4 - Drain
- 3 - Source

RECOMMENDED MINIMUM FOOT PRINT FOR SMD

SYMBOL	INCHES		MILLIMETERS	
	MIN	MAX	MIN	MAX
A	.193	.201	4.90	5.10
A1	.106	.114	2.70	2.90
A2	.001	.010	0.02	0.25
b	.045	.057	1.15	1.45
b2	.075	.083	1.90	2.10
C	.016	.026	0.40	0.65
C2	.057	.063	1.45	1.60
D	.543	.551	13.80	14.00
D1	.488	.500	12.40	12.70
D2	.320	.335	8.13	8.50
E	.624	.632	15.85	16.05
E1	.524	.535	13.30	13.60
E2	.045	.055	1.14	1.39
e	.215 BSC		5.45 BSC	
H	.736	.752	18.70	19.10
L	.094	.106	2.40	2.70
L1	.047	.055	1.20	1.40
L2	.039	.045	1.00	1.15
L3	.010 BSC		0.25 BSC	
L4	.150	.161	3.80	4.10

NOTE: ALL METAL SURFACE ARE MATTE PURE TIN PLATED EXCEPT TRIM AREA.
Pb PLATING THICKNESS (4 - 20 um)

TO-247 Outline

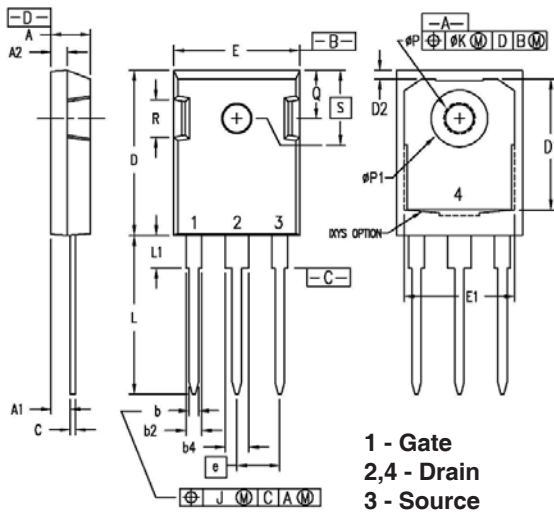

- 1 - Gate
- 2,4 - Drain
- 3 - Source

SYM	INCHES		MILLIMETERS	
	MIN	MAX	MIN	MAX
A	.190	.205	4.83	5.21
A1	.090	.100	2.29	2.54
A2	.075	.085	1.91	2.16
b	.045	.055	1.14	1.40
b2	.075	.087	1.91	2.20
b4	.115	.126	2.92	3.20
C	.024	.031	0.61	0.80
D	.819	.840	20.80	21.34
D1	.650	.690	16.51	17.53
D2	.035	.050	0.89	1.27
E	.620	.635	15.75	16.13
E1	.545	.565	13.84	14.35
e	.215 BSC		5.45 BSC	
J	--	.010	--	0.25
K	--	.025	--	0.64
L	.780	.810	19.81	20.57
L1	.150	.170	3.81	4.32
øP	.140	.144	3.55	3.65
øP1	.275	.290	6.99	7.37
Q	.220	.244	5.59	6.20
R	.170	.190	4.32	4.83
S	.242 BSC		6.15 BSC	

NOTE: This drawing will meet all dimensions requirement of JEDEC outlines TO-247 AD (R-PSIP-F3)



Disclaimer Notice - Information furnished is believed to be accurate and reliable. However, users should independently evaluate the suitability of and test each product selected for their own applications. Littelfuse products are not designed for, and may not be used in, all applications. Read complete Disclaimer Notice at www.littelfuse.com/disclaimer-electronics.
