

Depletion Mode MOSFET

IXTY01N100D
IXTU01N100D
IXTP01N100D

$V_{DSX} = 1000V$
 $R_{DS(on)} \leq 80\Omega$

N-Channel

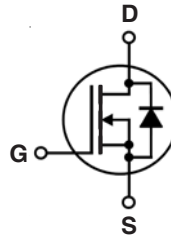

TO-252
(IXTY)

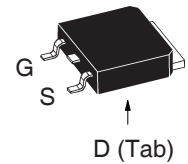

TO-251
(IXTU)

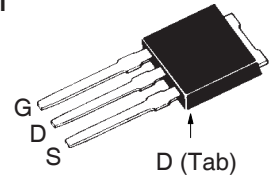

TO-220
(IXTP)

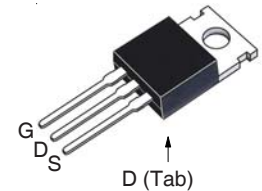

G = Gate D = Drain
S = Source Tab = Drain

Symbol	Test Conditions	Maximum Ratings	
V_{DSX}	$T_J = 25^\circ\text{C}$ to 150°C	1000	V
V_{DGX}	$T_J = 25^\circ\text{C}$ to 150°C	1000	V
V_{GSX}	Continuous	± 20	V
V_{GSM}	Transient	± 30	V
I_{DM}	$T_C = 25^\circ\text{C}$, Pulse Width Limited by T_J	400	mA
P_D	$T_C = 25^\circ\text{C}$	25	W
	$T_A = 25^\circ\text{C}$	1.1	W
T_J		- 55 ... +150	$^\circ\text{C}$
T_{JM}		150	$^\circ\text{C}$
T_{stg}		- 55 ... +150	$^\circ\text{C}$
T_L	Maximum Lead Temperature for Soldering	300	$^\circ\text{C}$
T_{SOLD}	1.6 mm (0.062in.) from Case for 10s	260	$^\circ\text{C}$
M_d	Mounting Torque (TO-220)	1.13 / 10	Nm/lb.in.
Weight	TO-252	0.35	g
	TO-251	0.40	g
	TO-220	3.00	g

Symbol	Test Conditions ($T_J = 25^\circ\text{C}$, Unless Otherwise Specified)	Characteristic Values		
		Min.	Typ.	Max.
BV_{DSX}	$V_{GS} = -10V$, $I_D = 25\mu\text{A}$	1000		V
$V_{GS(off)}$	$V_{DS} = 25V$, $I_D = 25\mu\text{A}$	- 2.0		- 4.5 V
I_{GSX}	$V_{GS} = \pm 20V$, $V_{DS} = 0V$			± 100 nA
$I_{DSX(off)}$	$V_{DS} = V_{DSX}$, $V_{GS} = -10V$ $T_J = 125^\circ\text{C}$			10 μA 250 μA
$R_{DS(on)}$	$V_{GS} = 0V$, $I_D = 50\text{mA}$, Note 1		50	80 Ω
$I_{D(on)}$	$V_{GS} = 0V$, $V_{DS} = 25V$, Note 1		400	mA

Features

- Normally ON Mode
- International Standard Packages
- Low $R_{DS(on)}$ HDMOS™ Process
- Rugged Polysilicon Gate Cell Structure
- Fast Switching Speed

Advantages

- Easy to Mount
- Space Savings
- High Power Density

Applications

- Level Shifting
- Triggers
- Solid State Relays
- Current Regulators

Symbol	Test Conditions ($T_J = 25^\circ\text{C}$, Unless Otherwise Specified)	Characteristic Values		
		Min.	Typ.	Max.
g_{fs}	$V_{DS} = 100\text{V}$, $I_D = 100\text{mA}$, Note 1	100	200	mS
C_{iss}	$V_{GS} = -10\text{V}$, $V_{DS} = 25\text{V}$, $f = 1\text{MHz}$		100	pF
C_{oss}			12	pF
C_{rss}			2	pF
$t_{d(on)}$	Resistive Switching Times $V_{GS} = \pm 5\text{V}$, $V_{DS} = 50\text{V}$, $I_D = 50\text{mA}$ $R_G = 30\Omega$ (External)		7	ns
t_r			10	ns
$t_{d(off)}$			34	ns
t_f			64	ns
$Q_{g(on)}$	$V_{GS} = \pm 5\text{V}$, $V_{DS} = 500\text{V}$, $I_D = 50\text{mA}$		5.8	nC
Q_{gs}			3.6	nC
Q_{gd}			0.4	nC
R_{thJC}	TO-220			5.0 $^\circ\text{C/W}$
R_{thCS}			0.50	$^\circ\text{C/W}$

Source-Drain Diode

Symbol	Test Conditions ($T_J = 25^\circ\text{C}$, Unless Otherwise Specified)	Characteristic Values		
		Min.	Typ.	Max.
V_{SD}	$I_F = 100\text{mA}$, $V_{GS} = -10\text{V}$, Note 1			1.5 V
t_{rr}	$I_F = 750\text{mA}$, $-di/dt = 100\text{A}/\mu\text{s}$ $V_R = 25\text{V}$, $V_{GS} = -10\text{V}$			1.5 μs

Note 1. Pulse test, $t \leq 300\mu\text{s}$, duty cycle, $d \leq 2\%$.

IXYS Reserves the Right to Change Limits, Test Conditions, and Dimensions.

IXYS MOSFETs and IGBTs are covered by one or more of the following U.S. patents:

4,835,592	4,931,844	5,049,961	5,237,481	6,162,665	6,404,065 B1	6,683,344	6,727,585	7,005,734 B2	7,157,338B2
4,860,072	5,017,508	5,063,307	5,381,025	6,259,123 B1	6,534,343	6,710,405 B2	6,759,692	7,063,975 B2	
4,881,106	5,034,796	5,187,117	5,486,715	6,306,728 B1	6,583,505	6,710,463	6,771,478 B2	7,071,537	

Fig. 1. Output Characteristics @ $T_J = 25^\circ\text{C}$

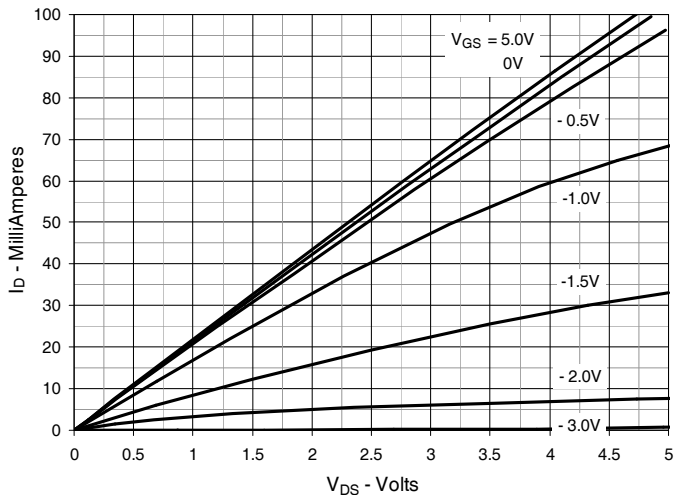

Fig. 2. Output Characteristics @ $T_J = 125^\circ\text{C}$

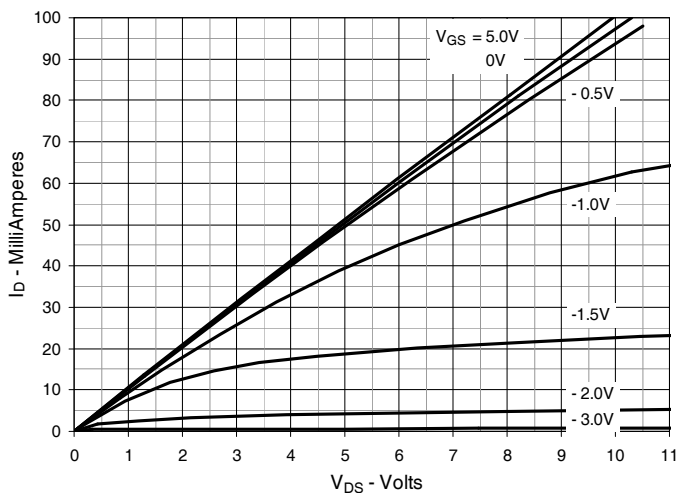

Fig. 3. Drain Current @ $T_J = 25^\circ\text{C}$

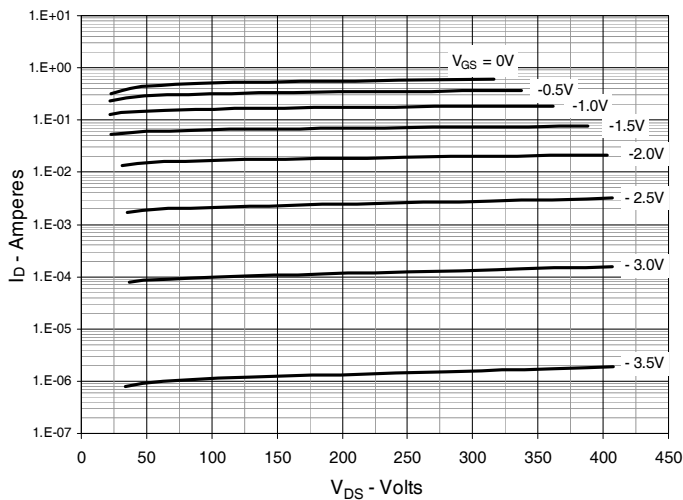

Fig. 4. Drain Current @ $T_J = 100^\circ\text{C}$

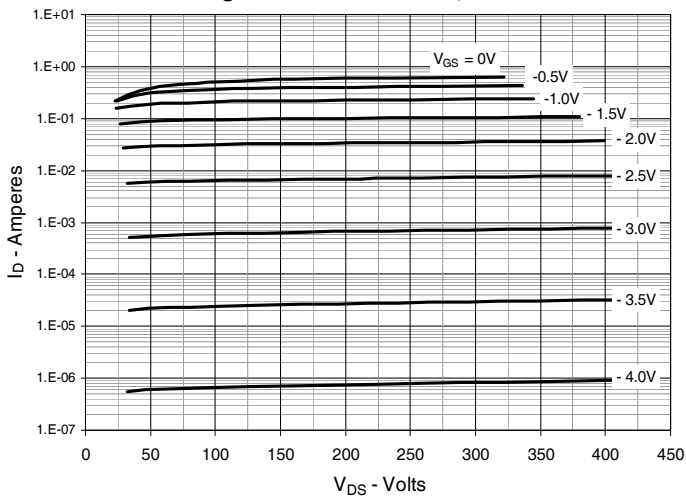

Fig. 5. Dynamic Resistance vs. Gate Voltage

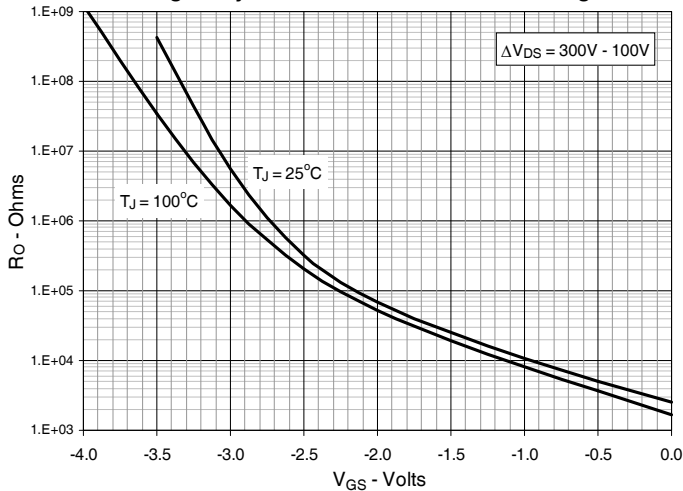

Fig. 6. Normalized $R_{DS(on)}$ vs. Junction Temperature

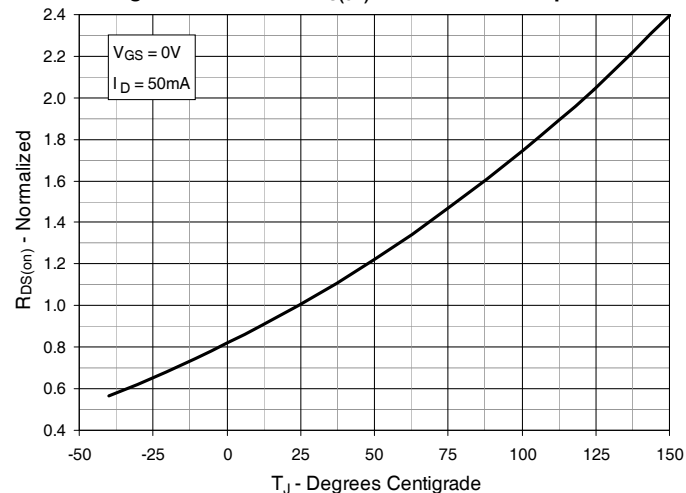

Fig. 7. $R_{DS(on)}$ Normalized to $I_D = 50mA$ Value vs. Drain Current

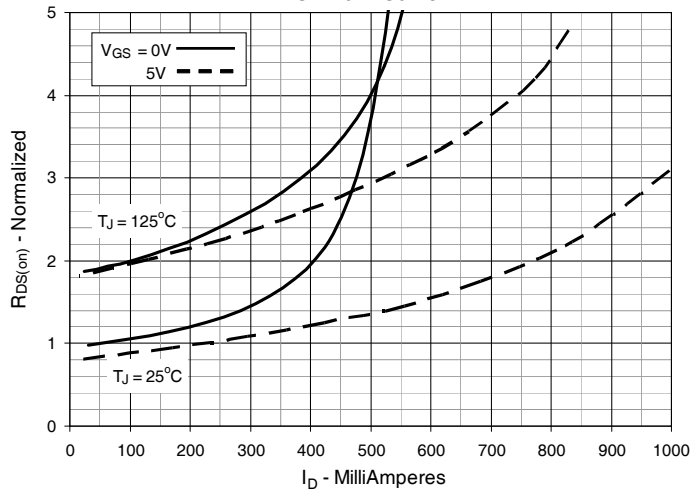

Fig. 8. Input Admittance

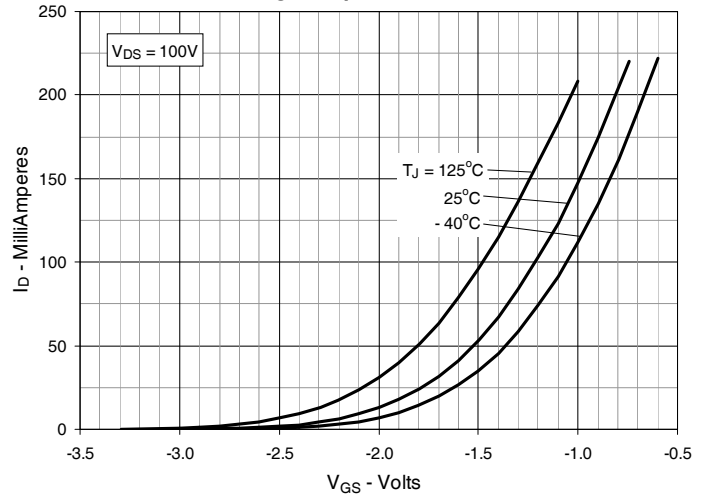

Fig. 9. Transconductance

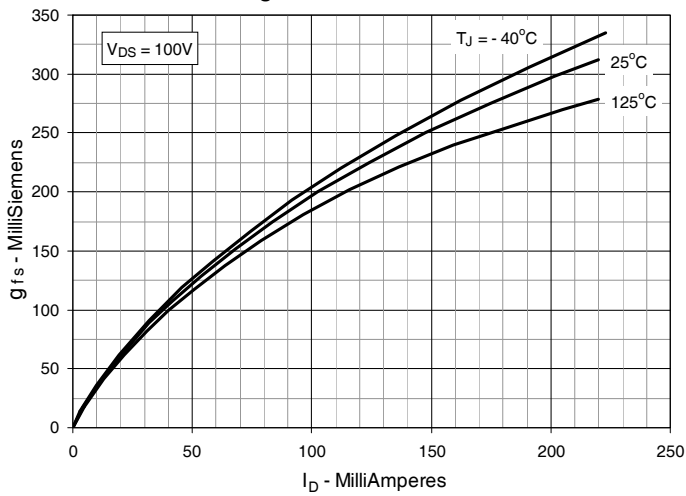

Fig. 10. Forward Voltage Drop of Intrinsic Diode

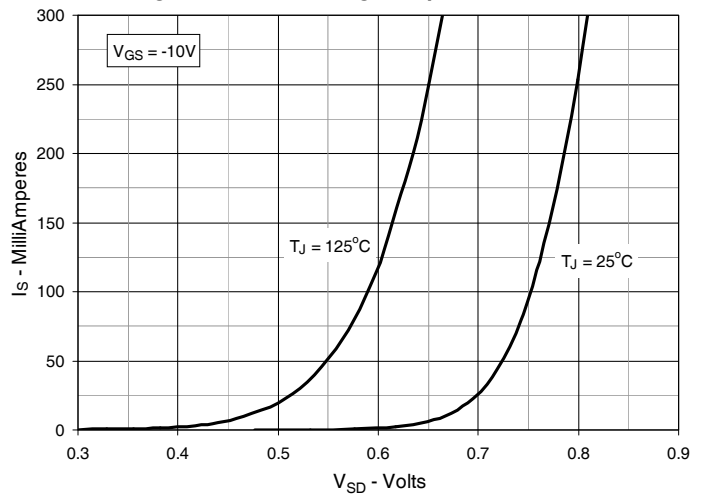

Fig. 11. Capacitance

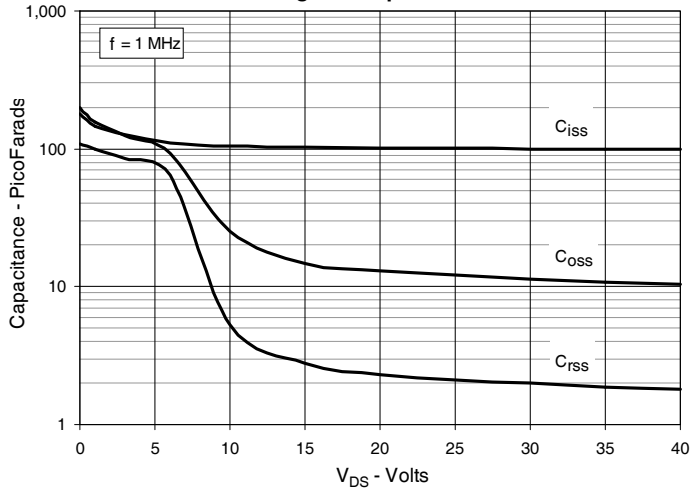

Fig. 12. Gate Charge

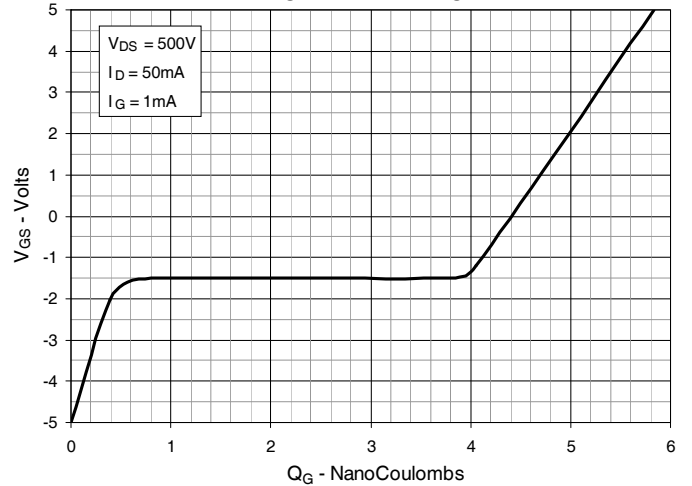

Fig. 13. Forward-Bias Safe Operating Area
@ $T_C = 25^\circ\text{C}$

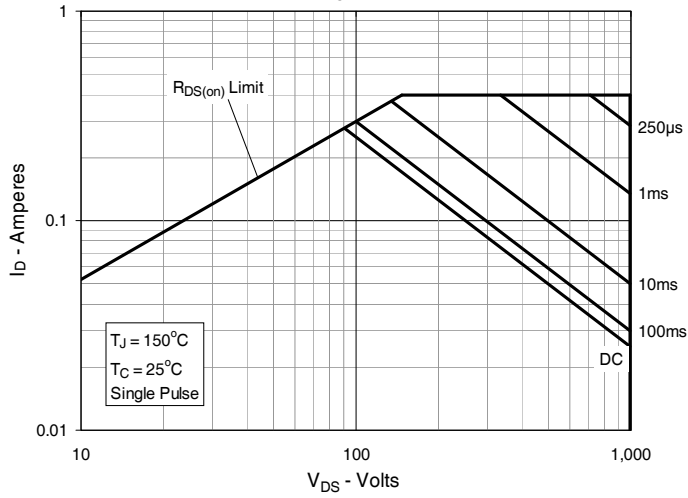

Fig. 14. Forward-Bias Safe Operating Area
@ $T_C = 75^\circ\text{C}$

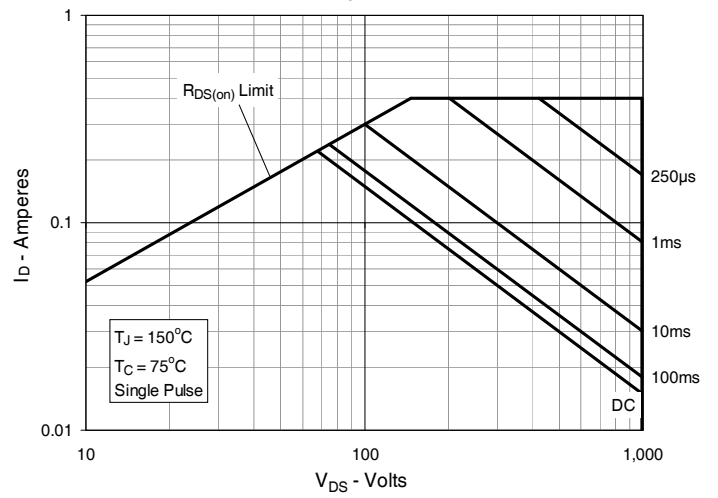
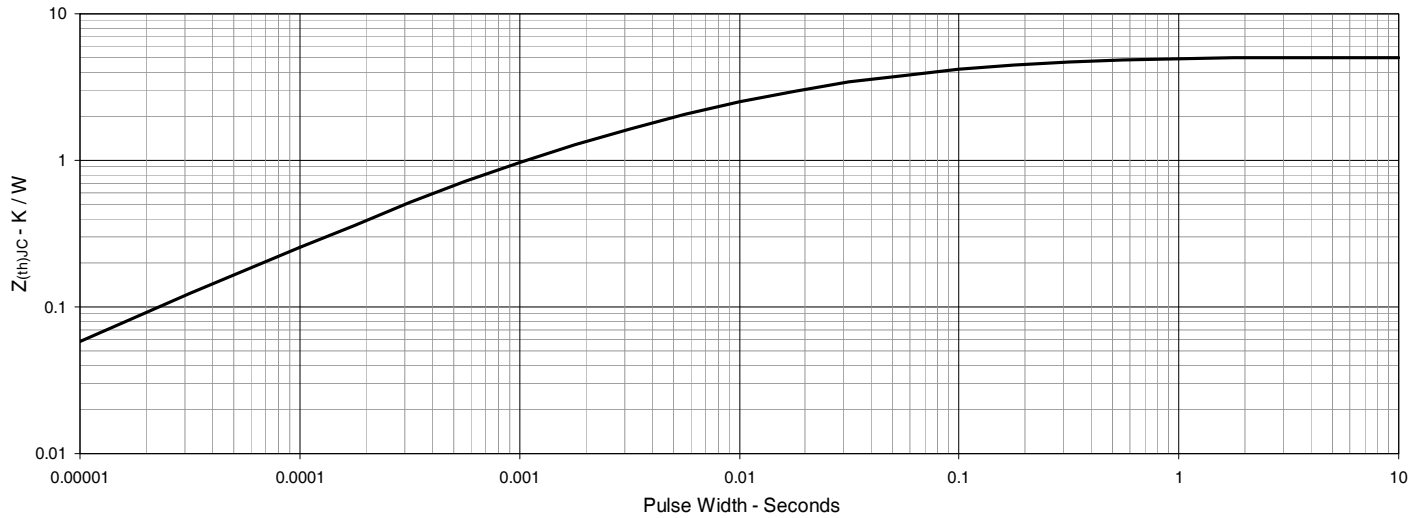
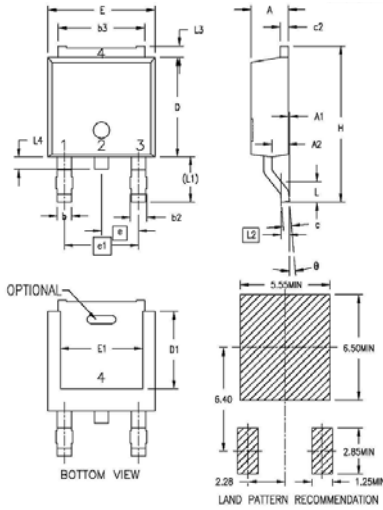

Fig. 15. Maximum Transient Thermal Impedance



TO-252 Outline



1 - Gate
2,4 - Drain
3 - Source

SYM	INCHES		MILLIMETERS	
	MIN	MAX	MIN	MAX
A	.086	.094	2.19	2.38
A1	0	.005	0	0.12
A2	.038	.046	0.97	1.17
b	.025	.035	0.64	0.89
b2	.030	.045	0.76	1.14
b3	.200	.215	5.08	5.46
c	.018	.024	0.46	0.61
c2	.018	.023	0.46	0.58
D	.235	.245	5.97	6.22
D1	.180	.205	4.57	5.21
E	.250	.265	6.35	6.73
E1	.170	.205	4.32	5.21
e	.090 BSC		2.28 BSC	
e1	.180 BSC		4.57 BSC	
H	.370	.410	9.40	10.42
L	.055	.070	1.40	1.78
L1	.100	.115	2.54	2.92
L2	.020 BSC		0.50 BSC	
L3	.025	.040	0.64	1.02
L4	.025	.040	0.64	1.02
θ	0°		10°	

NOTE: 1. This drawing comply JEDEC TO-252AA value except L3 dimension.
2. All metal surface are tin plated except trimmed area.

TO-251 Outline

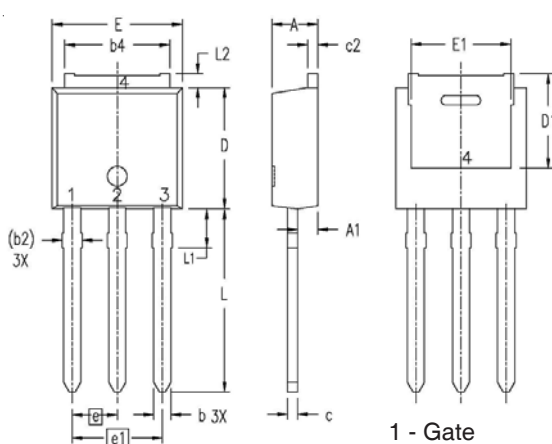

1 - Gate
2,4 - Drain
3 - Source

SYM	INCHES		MILLIMETERS	
	MIN	MAX	MIN	MAX
A	.087	.094	2.20	2.40
A1	.032	.048	0.82	1.22
b	.026	.034	0.66	0.86
(b2)	.030	.038	0.76	0.96
b4	.198	.222	5.04	5.64
c	.018	.024	0.45	0.60
c2	.016	.024	0.40	0.60
D	.232	.248	5.90	6.30
(D1)	.179	.195	4.55	4.95
E	.252	.268	6.40	6.80
(E1)	.191	.207	4.85	5.25
e	.090 BSC		2.28 BSC	
e1	.180 BSC		4.57 BSC	
L	.358	.374	9.10	9.50
L1	.063	.079	1.60	2.00
L2	.020	.035	0.50	0.90

NOTE: 1. ALL METAL AREA ARE MATTE PURE TIN PLATED EXCEPT TRIMMED AREA.
2. THESE DIMENSIONS DO NOT INCLUDE PROTRUSIONS OF THE MOLD.
3. THE () MARK IS THE REFERENCE ONLY.

TO-220 Outline

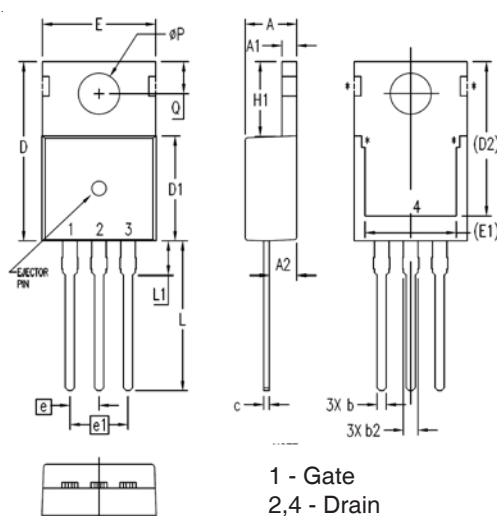

1 - Gate
2,4 - Drain
3 - Source

SYM	INCHES		MILLIMETERS	
	MIN	MAX	MIN	MAX
A	.169	.185	4.30	4.70
A1	.047	.055	1.20	1.40
A2	.079	.106	2.00	2.70
b	.024	.039	0.60	1.00
b2	.045	.057	1.15	1.45
c	.014	.026	0.35	0.65
D	.587	.626	14.90	15.90
D1	.335	.370	8.50	9.40
(D2)	.500	.531	12.70	13.50
E	.382	.406	9.70	10.30
(E1)	.283	.323	7.20	8.20
e	.100 BSC		2.54 BSC	
e1	.200 BSC		5.08 BSC	
H1	.244	.268	6.20	6.80
L	.492	.547	12.50	13.90
L1	.110	.154	2.80	3.90
ØP	.134	.150	3.40	3.80
Q	.106	.126	2.70	3.20

NOTE: 1. All metal surface are matte pure tin plated except trimmed area.



Disclaimer Notice - Information furnished is believed to be accurate and reliable. However, users should independently evaluate the suitability of and test each product selected for their own applications. Littelfuse products are not designed for, and may not be used in, all applications. Read complete Disclaimer Notice at www.littelfuse.com/disclaimer-electronics.
