

# 1200V XPT™ Gen 4 IGBT

# IXYX110N120C4

High Speed IGBT for 20-50kHz Switching

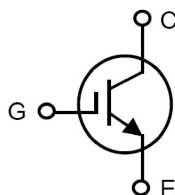

$V_{CES} = 1200V$   
 $I_{C110} = 110A$   
 $V_{CE(sat)} \leq 2.40V$   
 $t_{fi(typ)} = 37ns$

PLUS247 (IXYX)

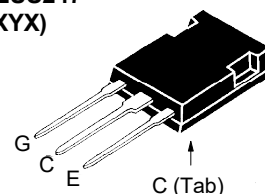

G = Gate      C = Collector  
 E = Emitter    Tab = Collector

Symbol	Test Conditions	Maximum Ratings	
$V_{CES}$	$T_J = 25^\circ C$ to $175^\circ C$	1200	V
$V_{CGR}$	$T_J = 25^\circ C$ to $175^\circ C$ , $R_{GE} = 1M\Omega$	1200	V
$V_{GES}$	Continuous	$\pm 20$	V
$V_{GEM}$	Transient	$\pm 30$	V
$I_{C25}$	$T_C = 25^\circ C$ (Chip Capability)	310	A
$I_{LRMS}$	Terminal Current Limit	160	A
$I_{C110}$	$T_C = 110^\circ C$	110	A
$I_{CM}$	$T_C = 25^\circ C$ , 1ms	740	A
<b>SSOA (RBSOA)</b>	$V_{GE} = 15V$ , $T_{VJ} = 150^\circ C$ , $R_G = 2\Omega$ Clamped Inductive Load	$I_{CM} = 220$ $0.8 \cdot V_{CES}$	A V
$P_C$	$T_C = 25^\circ C$	1360	W
$T_J$		-55 ... +175	$^\circ C$
$T_{JM}$		175	$^\circ C$
$T_{stg}$		-55 ... +175	$^\circ C$
$T_L$	Maximum Lead Temperature for Soldering	300	$^\circ C$
$T_{SOLD}$	1.6 mm (0.062 in.) from Case for 10s	260	$^\circ C$
$F_C$	Mounting Force	20..120 / 4.5..27	N/lb
<b>Weight</b>		6	g

## Features

- Optimized for Low Switching Losses
- Positive Thermal Coefficient of  $V_{CE(sat)}$
- International Standard Package

## Advantages

- High Power Density
- Low Gate Drive Requirement

## Applications

- Power Inverters
- UPS
- Motor Drives
- SMPS
- PFC Circuits
- Battery Chargers
- Welding Machines
- Lamp Ballasts

Symbol	Test Conditions ( $T_J = 25^\circ C$ , Unless Otherwise Specified)	Characteristic Values		
		Min.	Typ.	Max.
$BV_{CES}$	$I_C = 250\mu A$ , $V_{GE} = 0V$	1200		V
$V_{GE(th)}$	$I_C = 3mA$ , $V_{CE} = V_{GE}$	4.5		6.5 V
$I_{CES}$	$V_{CE} = V_{CES}$ , $V_{GE} = 0V$ $T_J = 150^\circ C$			25 $\mu A$ 1.5 mA
$I_{GES}$	$V_{CE} = 0V$ , $V_{GE} = \pm 20V$			$\pm 100$ nA
$V_{CE(sat)}$	$I_C = I_{C110}$ , $V_{GE} = 15V$ , Note 1 $T_J = 150^\circ C$		1.90 2.27	2.40 V V

Symbol Test Conditions ( $T_J = 25^\circ\text{C}$ Unless Otherwise Specified)		Characteristic Values		
		Min.	Typ.	Max.
$g_{fs}$	$I_C = 60\text{A}, V_{CE} = 10\text{V}, \text{Note 1}$	40	68	S
$C_{ies}$	$V_{CE} = 25\text{V}, V_{GE} = 0\text{V}, f = 1\text{MHz}$		5420	pF
$C_{oes}$			335	pF
$C_{res}$			220	pF
$Q_{g(on)}$	$I_C = I_{C110}, V_{GE} = 15\text{V}, V_{CE} = 0.5 \cdot V_{CES}$		330	nC
$Q_{ge}$			55	nC
$Q_{gc}$			138	nC
$t_{d(on)}$	<b>Inductive load, <math>T_J = 25^\circ\text{C}</math></b> $I_C = 50\text{A}, V_{GE} = 15\text{V}$ $V_{CE} = 0.5 \cdot V_{CES}, R_G = 2\Omega$ Note 2		40	ns
$t_{ri}$			48	ns
$E_{on}$			3.6	mJ
$t_{d(off)}$			320	ns
$t_{fi}$			37	ns
$E_{off}$			1.9	mJ
$t_{d(on)}$	<b>Inductive load, <math>T_J = 150^\circ\text{C}</math></b> $I_C = 50\text{A}, V_{GE} = 15\text{V}$ $V_{CE} = 0.5 \cdot V_{CES}, R_G = 2\Omega$ Note 2		36	ns
$t_{ri}$			37	ns
$E_{on}$			5.3	mJ
$t_{d(off)}$			326	ns
$t_{fi}$			90	ns
$E_{off}$			3.2	mJ
$R_{thJC}$				0.11 $^\circ\text{C/W}$
$R_{thCS}$		0.15		$^\circ\text{C/W}$

**Notes:**

1. Pulse test,  $t \leq 300\mu\text{s}$ , duty cycle,  $d \leq 2\%$ .
2. Switching times & energy losses may increase for higher  $V_{CE}$  (clamp),  $T_J$  or  $R_G$ .

Littelfuse reserves the right to change limits, test conditions, and dimensions.

IXYS MOSFETs and IGBTs are covered	4,835,592	4,931,844	5,049,961	5,237,481	6,162,665	6,404,065 B1	6,683,344	6,727,585	7,005,734 B2	7,157,338B2
by one or more of the following U.S. patents:	4,860,072	5,017,508	5,063,307	5,381,025	6,259,123 B1	6,534,343	6,710,405 B2	6,759,692	7,063,975 B2	
	4,881,106	5,034,796	5,187,117	5,486,715	6,306,728 B1	6,583,505	6,710,463	6,771,478 B2	7,071,537	

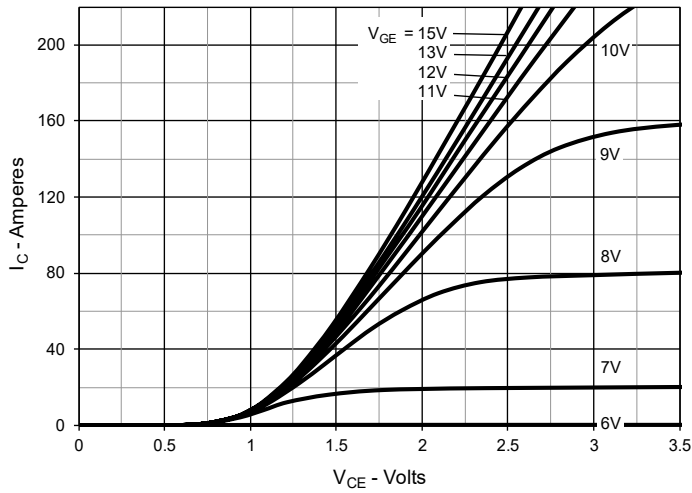
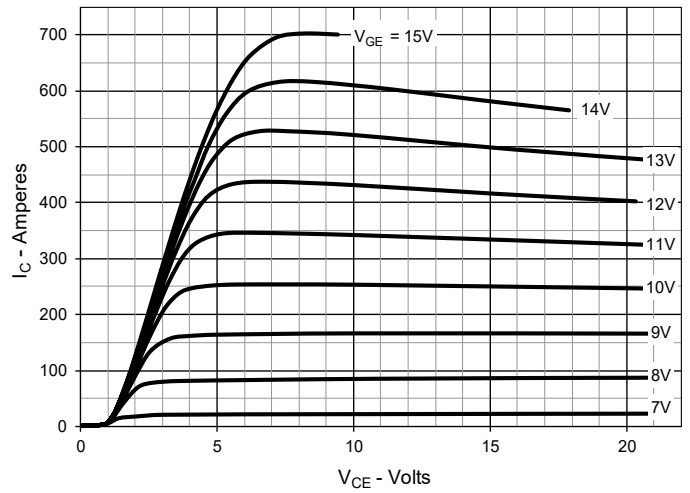
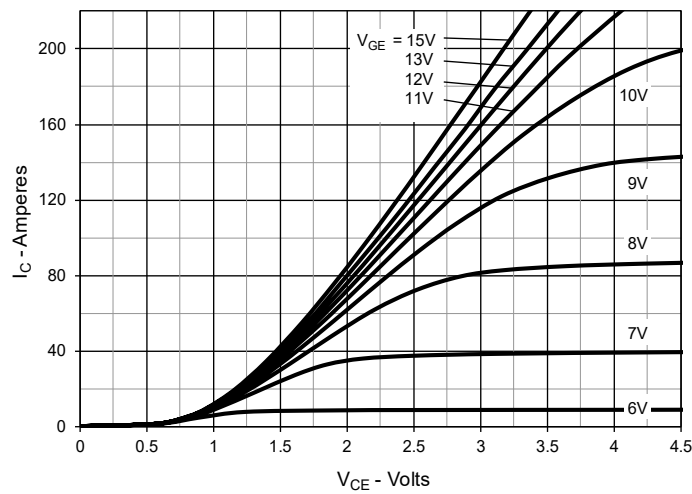
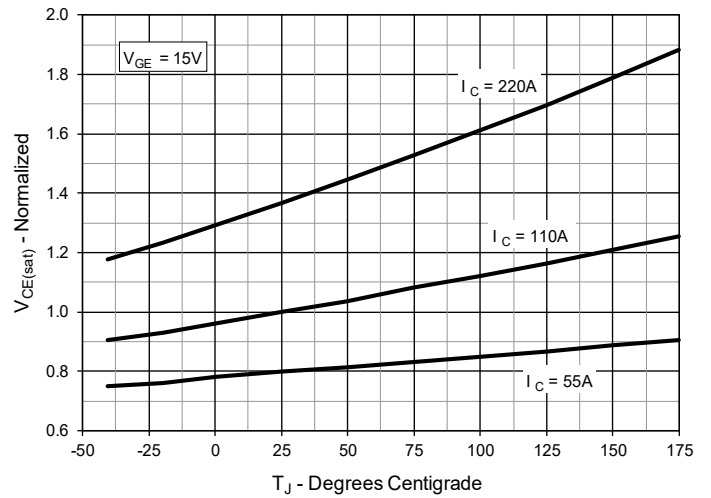
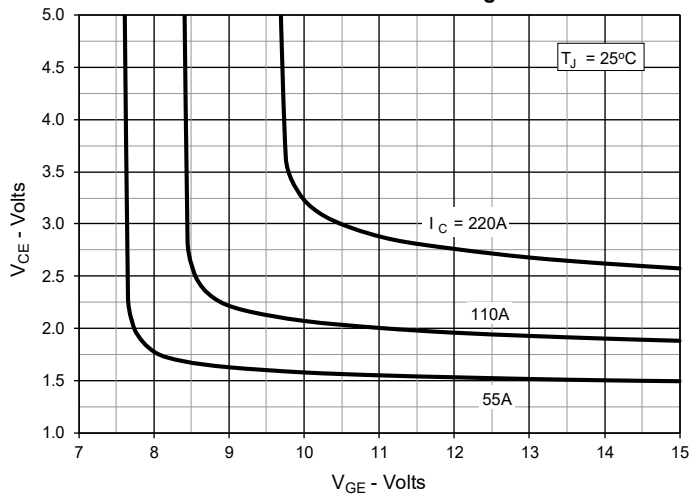
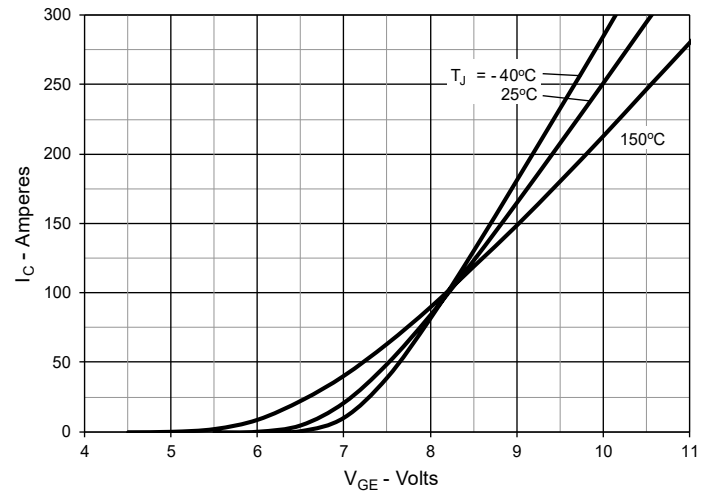
**Fig. 1. Output Characteristics @  $T_J = 25^\circ\text{C}$** 

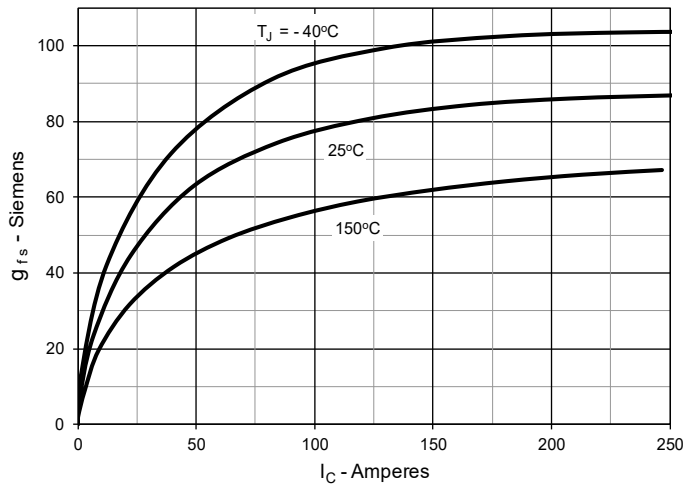
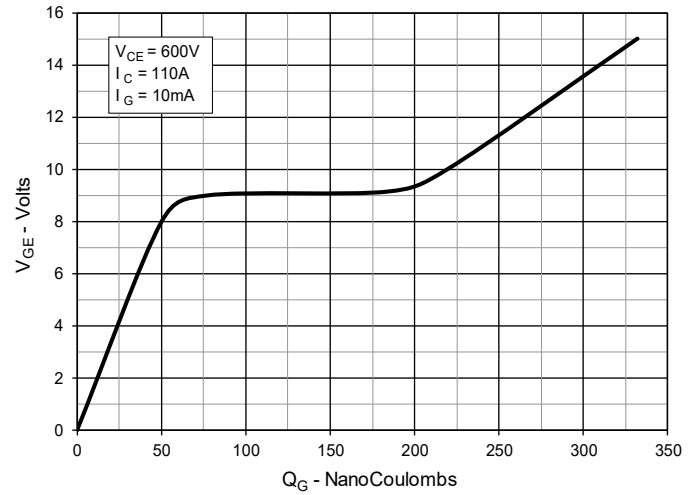
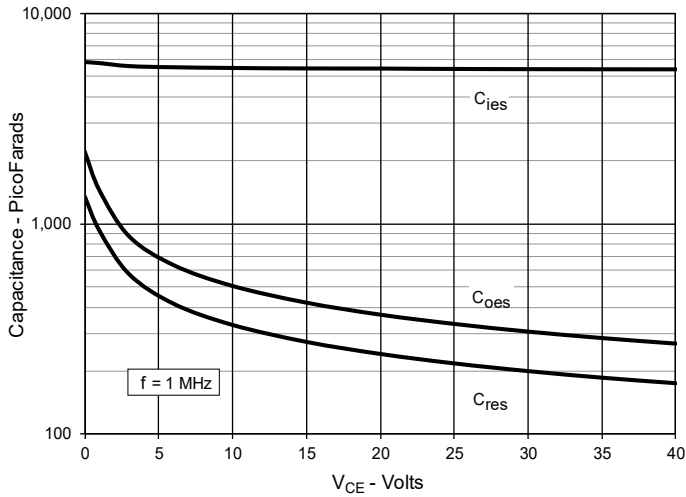
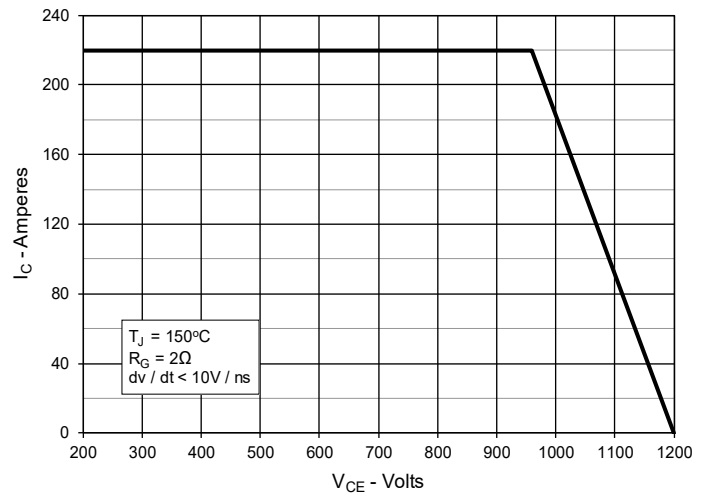
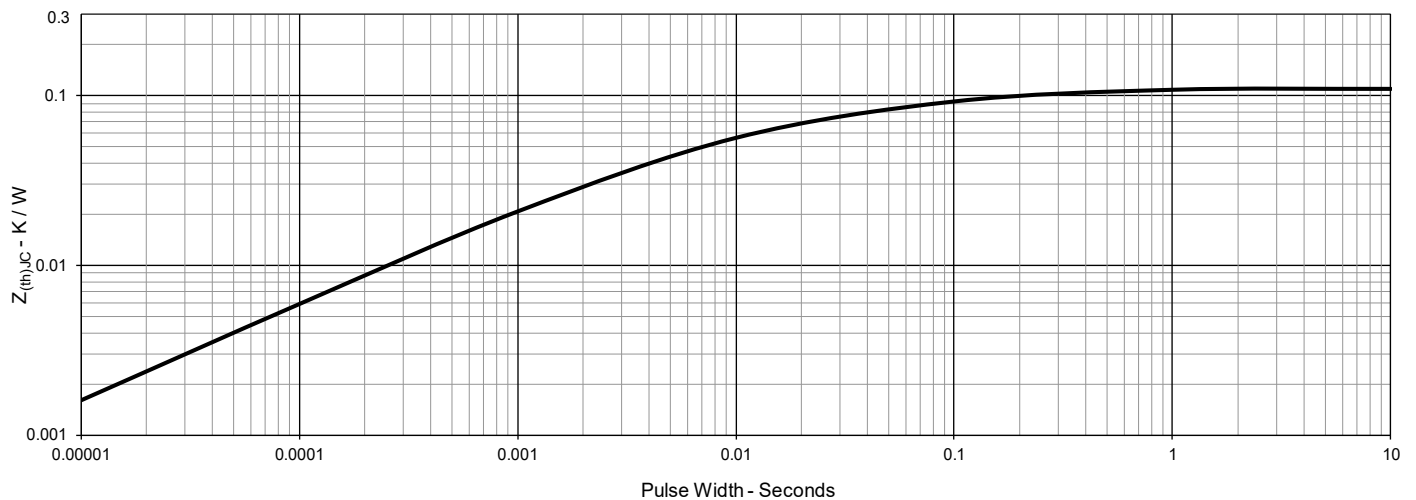
**Fig. 2. Extended Output Characteristics @  $T_J = 25^\circ\text{C}$** 

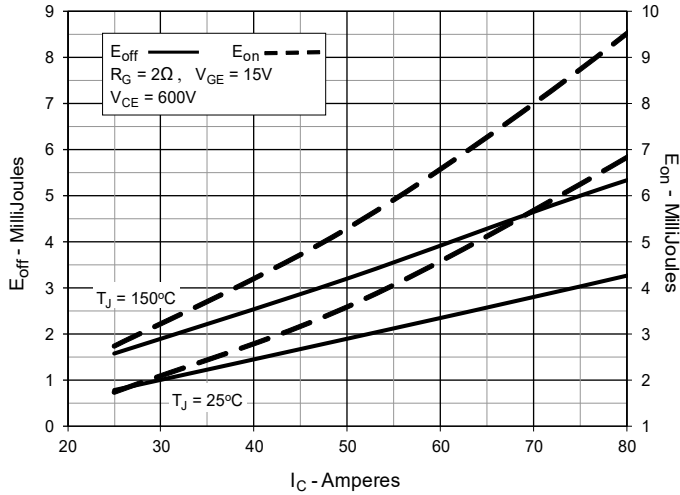
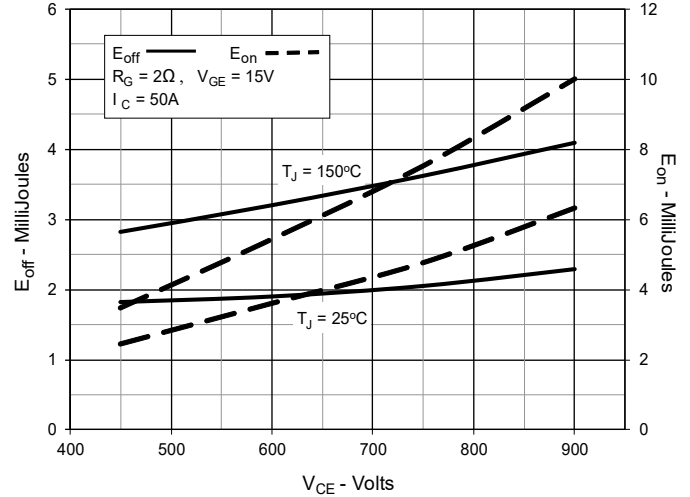
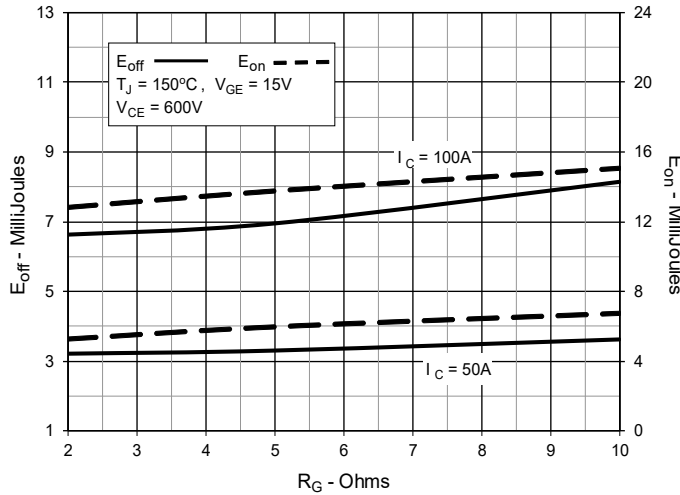
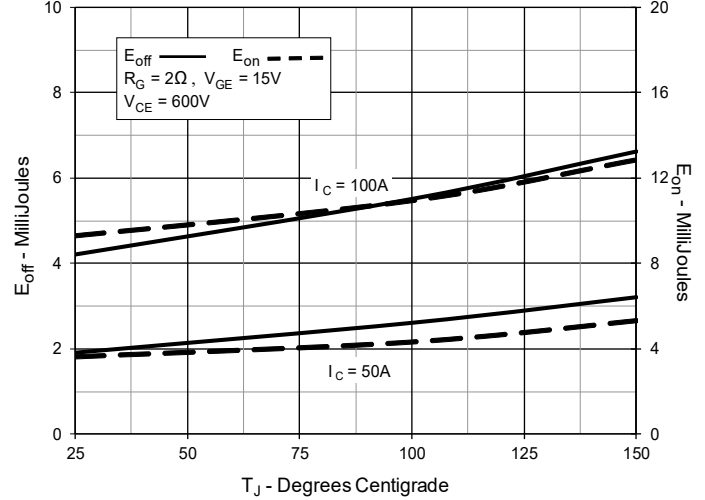
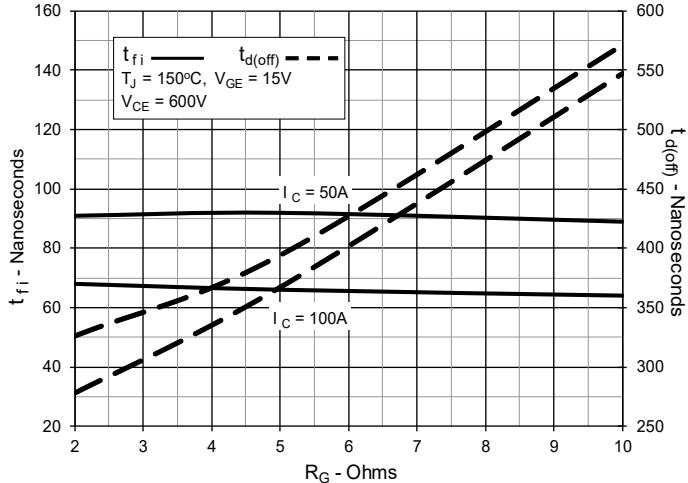
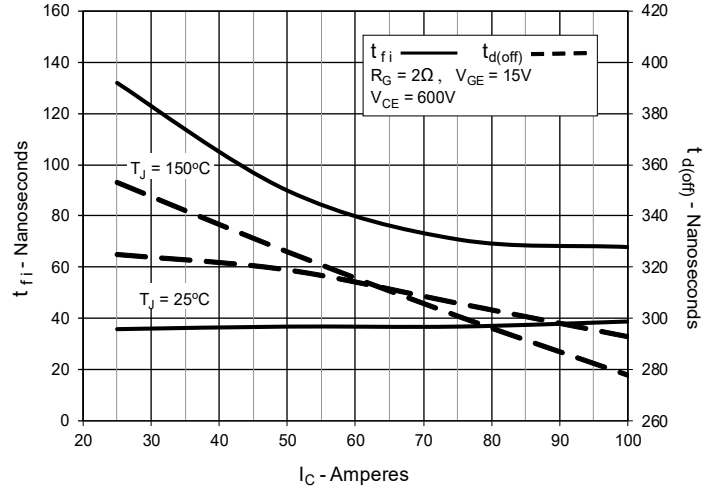
**Fig. 3. Output Characteristics @  $T_J = 150^\circ\text{C}$** 

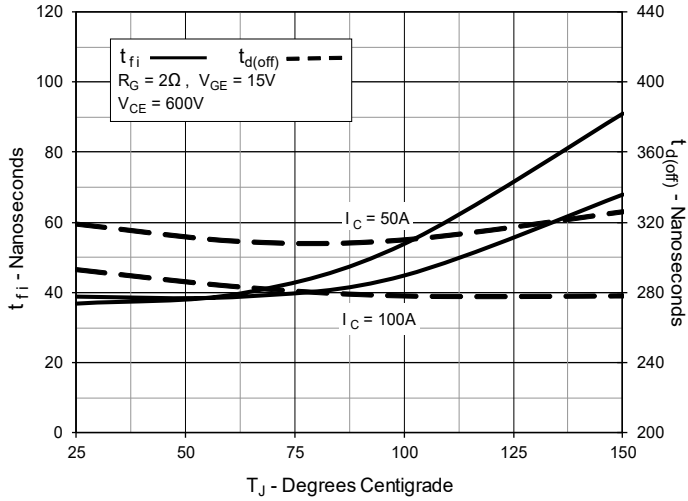
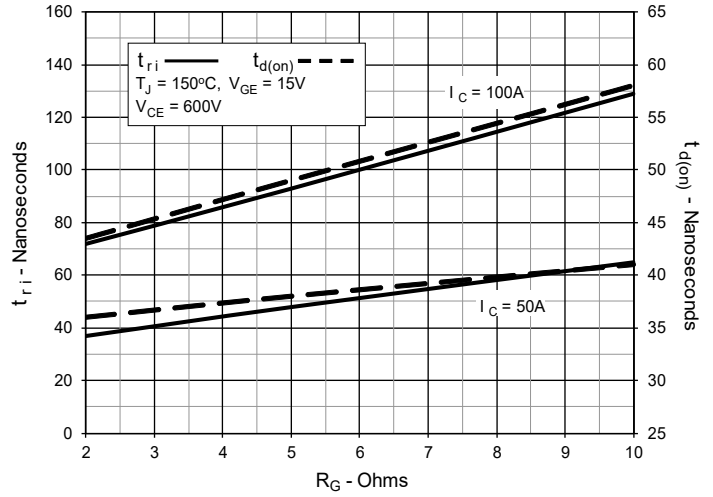
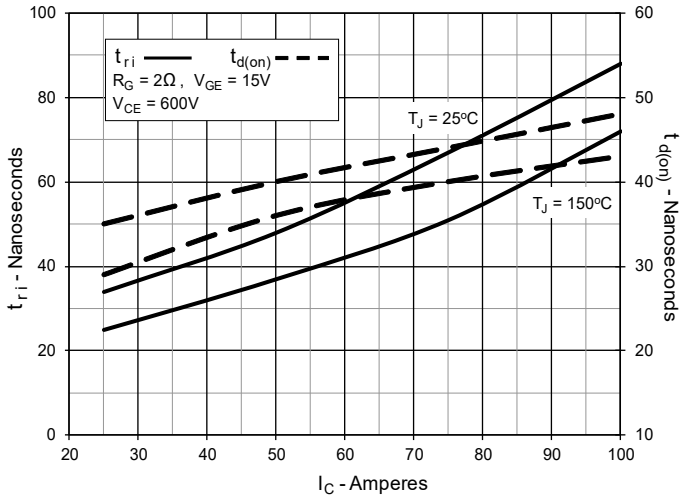
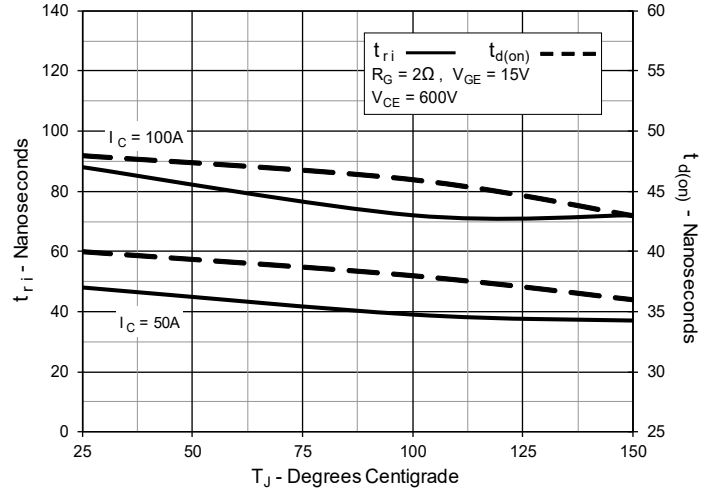
**Fig. 4. Dependence of  $V_{CE(sat)}$  on Junction Temperature**

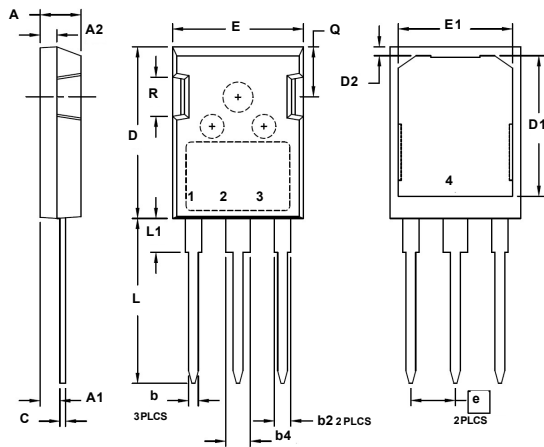
**Fig. 5. Collector-to-Emitter Voltage vs. Gate-to-Emitter Voltage**

**Fig. 6. Input Admittance**

**Fig. 7. Transconductance**

**Fig. 8. Gate Charge**

**Fig. 9. Capacitance**

**Fig. 10. Reverse-Bias Safe Operating Area**

**Fig. 11. Maximum Transient Thermal Impedance**

**Fig. 12. Inductive Switching Energy Loss vs. Collector Current**

**Fig. 13. Inductive Switching Energy Loss vs. Collector-Emitter Voltage**

**Fig. 14. Inductive Switching Energy Loss vs. Gate Resistance**

**Fig. 15. Inductive Switching Energy Loss vs. Junction Temperature**

**Fig. 16. Inductive Turn-off Switching Times vs. Gate Resistance**

**Fig. 17. Inductive Turn-off Switching Times vs. Collector Current**

**Fig. 18. Inductive Turn-off Switching Times vs. Junction Temperature**

**Fig. 19. Inductive Turn-on Switching Times vs. Gate Resistance**

**Fig. 20. Inductive Turn-on Switching Times vs. Collector Current**

**Fig. 21. Inductive Turn-on Switching Times vs. Junction Temperature**

**PLUS247™ Outline**

- 1 - Gate
- 2,4 - Collector
- 3 - Emitter

SYM	INCHES		MILLIMETERS	
	MIN	MAX	MIN	MAX
A	.190	.205	4.83	5.21
A1	.090	.100	2.29	2.54
A2	.075	.085	1.91	2.16
b	.045	.055	1.14	1.40
b2	.075	.087	1.91	2.20
b4	.115	.126	2.92	3.20
C	.024	.031	0.61	0.80
D	.819	.840	20.80	21.34
D1	.650	.690	16.51	17.53
D2	.035	.050	0.89	1.27
E	.620	.635	15.75	16.13
E1	.520	.560	13.08	14.22
e	.215 BSC		5.45 BSC	
L	.780	.810	19.81	20.57
L1	.150	.170	3.81	4.32
Q	.220	.244	5.59	6.20
R	.170	.190	4.32	4.83