

XPT™ 650V IGBT GenX3™ w/ Diode

IXYN120N65B3D1

$V_{CES} = 650V$
 $I_{C110} = 120A$
 $V_{CE(sat)} \leq 1.90V$
 $t_{fi(typ)} = 107ns$

Extreme Light Punch through IGBT for 10-30kHz Switching

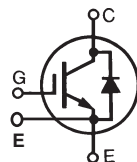

Symbol	Test Conditions	Maximum Ratings	
		Value	Unit
V_{CES}	$T_J = 25^\circ C$ to $175^\circ C$	650	V
V_{CGR}	$T_J = 25^\circ C$ to $175^\circ C$, $R_{GE} = 1M\Omega$	650	V
V_{GES}	Continuous	± 20	V
V_{GEM}	Transient	± 30	V
I_{C25}	$T_C = 25^\circ C$ (Chip Capability)	250	A
I_{LRMS}	Terminal Current Limit	200	A
I_{C110}	$T_C = 110^\circ C$	120	A
I_{F110}	$T_C = 110^\circ C$	86	A
I_{CM}	$T_C = 25^\circ C$, 1ms	770	A
I_A	$T_C = 25^\circ C$	60	A
E_{AS}	$T_C = 25^\circ C$	1	J
SSOA (RBSOA)	$V_{GE} = 15V$, $T_{VJ} = 150^\circ C$, $R_G = 2\Omega$ Clamped Inductive Load	$I_{CM} = 240$ $V_{CE} \leq V_{CES}$	A
t_{sc} (SCSOA)	$V_{GE} = 15V$, $V_{CE} = 400V$, $T_J = 150^\circ C$ $R_G = 82\Omega$, Non Repetitive	8	μs
P_C	$T_C = 25^\circ C$	830	W
T_J		-55 ... +175	$^\circ C$
T_{JM}		175	$^\circ C$
T_{stg}		-55 ... +175	$^\circ C$
TV_{ISOL}	50/60Hz $I_{ISOL} \leq 1mA$	$t = 1min$ $t = 1s$	2500 3000 V~ V~
M_d	Mounting Torque Terminal Connection Torque	1.5/13 1.3/11.5	Nm/lb.in Nm/lb.in
Weight		30	g

SOT-227B, miniBLOC
E153432

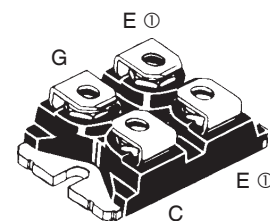

G = Gate, C = Collector, E = Emitter
Ⓢ either emitter terminal can be used as Main or Kelvin Emitter

Features

- International Standard Package
- miniBLOC, with Aluminium Nitride Isolation
- 2500V~ Isolation Voltage
- Optimized for 10-30kHz Switching
- Square RBSOA
- Avalanche Rated
- Short Circuit Capability
- High Current Handling Capability
- Anti-Parallel Fast Diode

Advantages

- High Power Density
- Low Gate Drive Requirement

Applications

- Power Inverters
- UPS
- Motor Drives
- SMPS
- PFC Circuits
- Battery Chargers
- Welding Machines
- Lamp Ballasts

Symbol	Test Conditions ($T_J = 25^\circ C$, Unless Otherwise Specified)	Characteristic Values		
		Min.	Typ.	Max.
BV_{CES}	$I_C = 250\mu A$, $V_{GE} = 0V$	650		V
$V_{GE(th)}$	$I_C = 250\mu A$, $V_{CE} = V_{GE}$	3.5		6.0 V
I_{CES}	$V_{CE} = V_{CES}$, $V_{GE} = 0V$ $T_J = 150^\circ C$			25 μA 1.5 mA
I_{GES}	$V_{CE} = 0V$, $V_{GE} = \pm 20V$			± 100 nA
$V_{CE(sat)}$	$I_C = 100A$, $V_{GE} = 15V$, Note 1 $T_J = 150^\circ C$		1.55 1.77	V V

Symbol Test Conditions ($T_J = 25^\circ\text{C}$ Unless Otherwise Specified)		Characteristic Values		
		Min.	Typ.	Max.
g_{fs}	$I_C = 60\text{A}, V_{CE} = 10\text{V}$, Note 1	35	58	S
C_{ies}	$V_{CE} = 25\text{V}, V_{GE} = 0\text{V}, f = 1\text{MHz}$		6900	pF
C_{oes}			586	pF
C_{res}			146	pF
$Q_{g(on)}$	$I_C = 120\text{A}, V_{GE} = 15\text{V}, V_{CE} = 0.5 \cdot V_{CES}$		250	nC
Q_{ge}			52	nC
Q_{gc}			110	nC
$t_{d(on)}$	Inductive load, $T_J = 25^\circ\text{C}$ $I_C = 50\text{A}, V_{GE} = 15\text{V}$ $V_{CE} = 400\text{V}, R_G = 2\Omega$ Note 2		30	ns
t_{ri}			28	ns
E_{on}			1.34	mJ
$t_{d(off)}$			168	ns
t_{fi}			107	ns
E_{off}			1.50	mJ
$t_{d(on)}$	Inductive load, $T_J = 150^\circ\text{C}$ $I_C = 50\text{A}, V_{GE} = 15\text{V}$ $V_{CE} = 400\text{V}, R_G = 2\Omega$ Note 2		30	ns
t_{ri}			30	ns
E_{on}			2.60	mJ
$t_{d(off)}$			226	ns
t_{fi}			196	ns
E_{off}			2.20	mJ
R_{thJC}				0.18 $^\circ\text{C/W}$
R_{thCS}		0.05		$^\circ\text{C/W}$

Reverse Diode (FRED)

Symbol Test Conditions ($T_J = 25^\circ\text{C}$ Unless Otherwise Specified)		Characteristic Values		
		Min.	Typ.	Max.
V_F	$I_F = 100\text{A}, V_{GE} = 0\text{V}$, Note 1			2.70 V
		$T_J = 150^\circ\text{C}$	1.7	V
I_{rr}	$I_F = 100\text{A}, V_{GE} = 0\text{V}, -di_F/dt = 700\text{A}/\mu\text{s},$ $V_R = 400\text{V}$	$T_J = 150^\circ\text{C}$	45	A
t_{rr}		$T_J = 150^\circ\text{C}$	156	ns
R_{thJC}				0.38 $^\circ\text{C/W}$

Notes:

1. Pulse test, $t \leq 300\mu\text{s}$, duty cycle, $d \leq 2\%$.
2. Switching times & energy losses may increase for higher $V_{CE}(\text{clamp})$, T_J or R_G .

IXYS Reserves the Right to Change Limits, Test Conditions, and Dimensions.

Fig. 1. Output Characteristics @ $T_J = 25^\circ\text{C}$

Fig. 2. Extended Output Characteristics @ $T_J = 25^\circ\text{C}$

Fig. 3. Output Characteristics @ $T_J = 150^\circ\text{C}$

Fig. 4. Dependence of $V_{CE(sat)}$ on Junction Temperature

Fig. 5. Collector-to-Emitter Voltage vs. Gate-to-Emitter Voltage

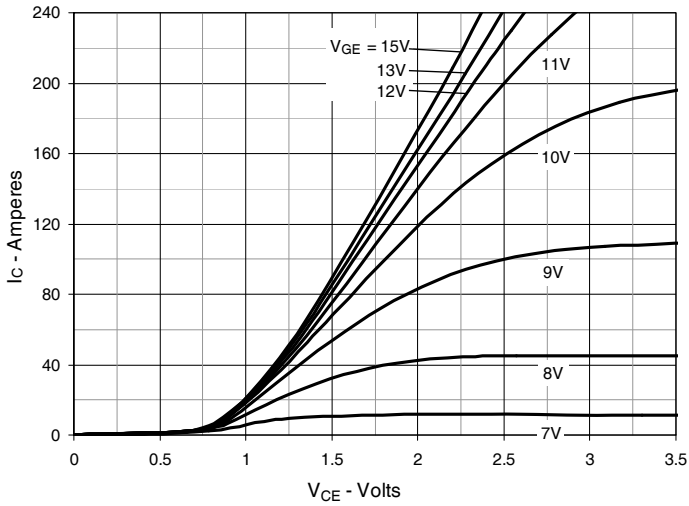
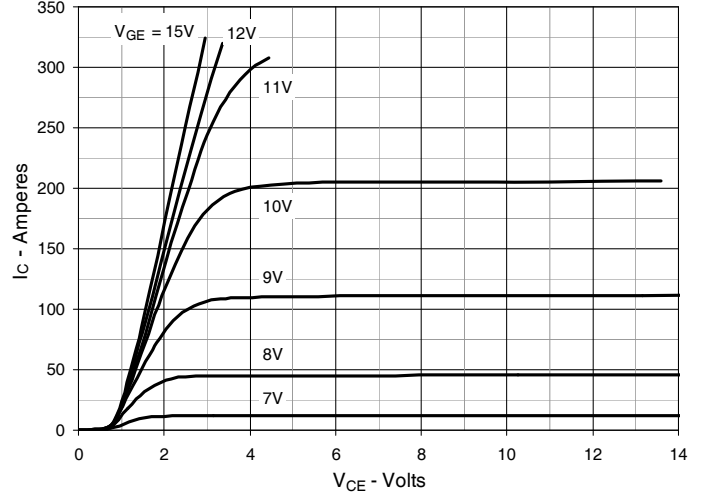
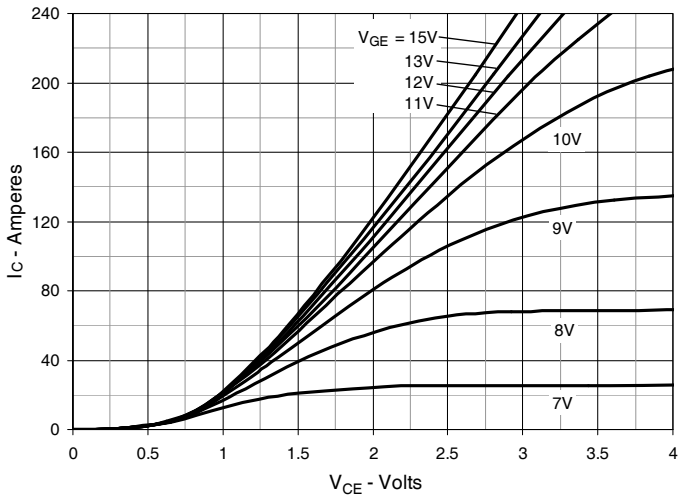
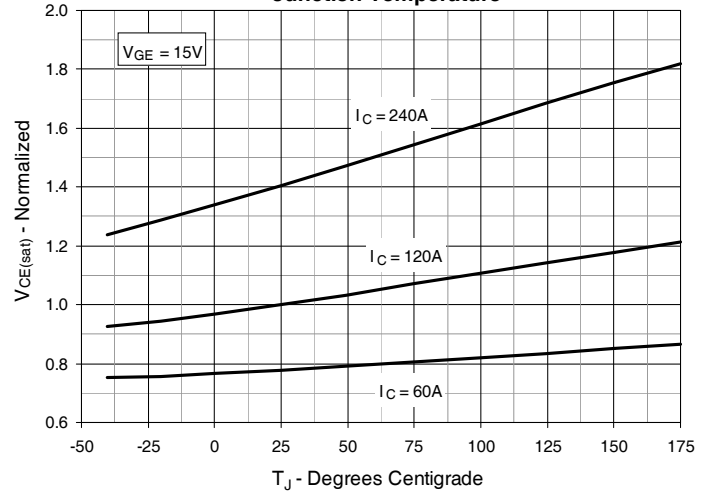
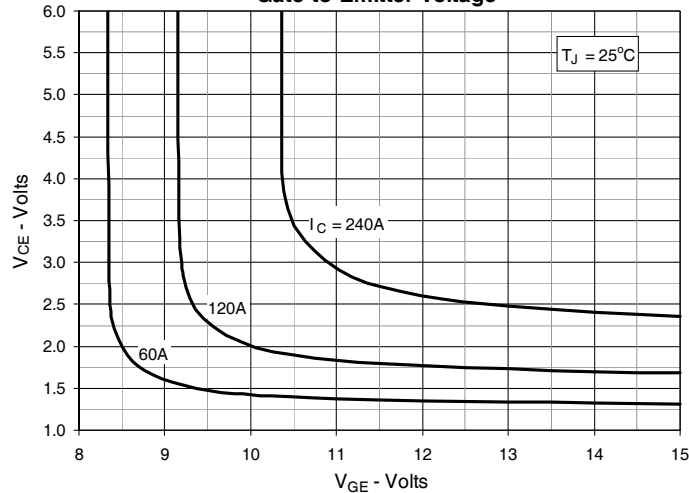
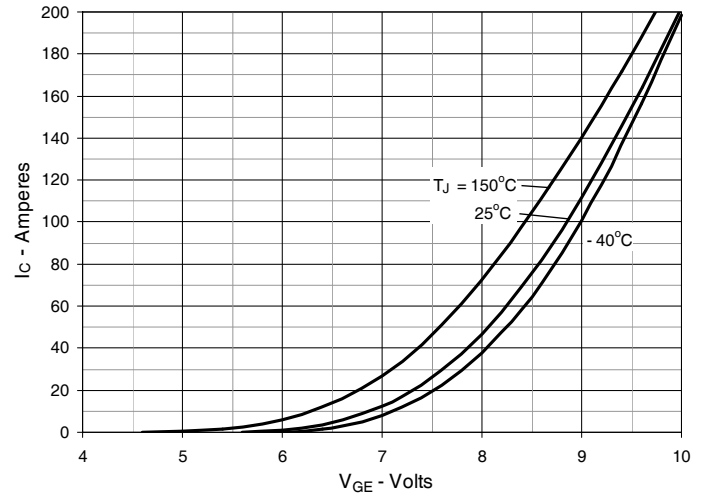
Fig. 6. Input Admittance

Fig. 7. Transconductance

Fig. 8. Gate Charge

Fig. 9. Capacitance

Fig. 10. Reverse-Bias Safe Operating Area

Fig. 11. Forward-Bias Safe Operating Area

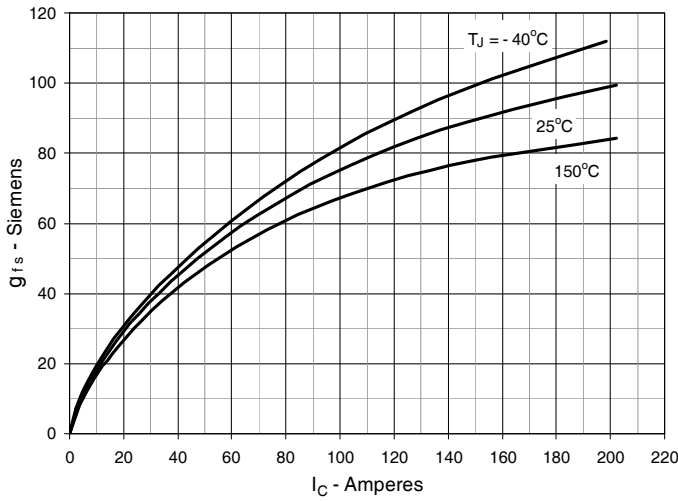
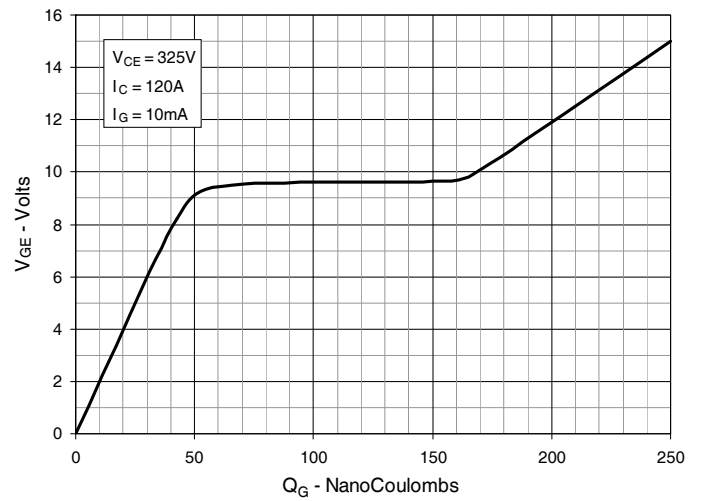
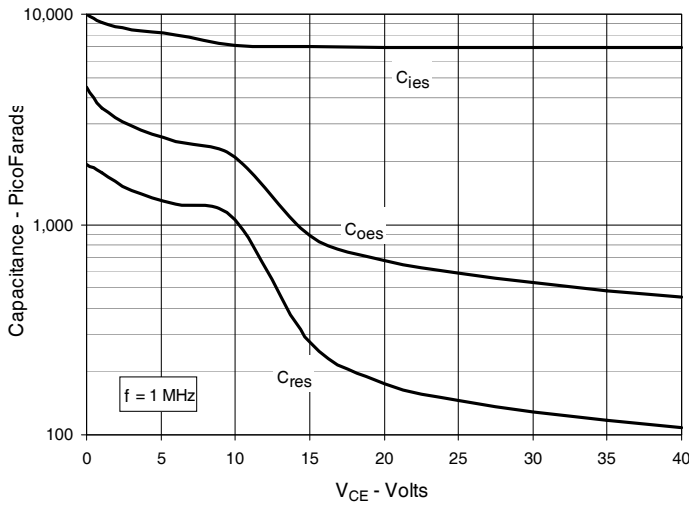
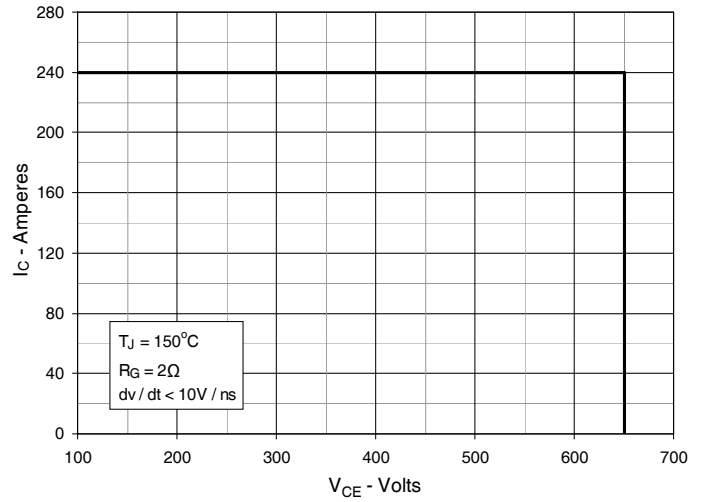
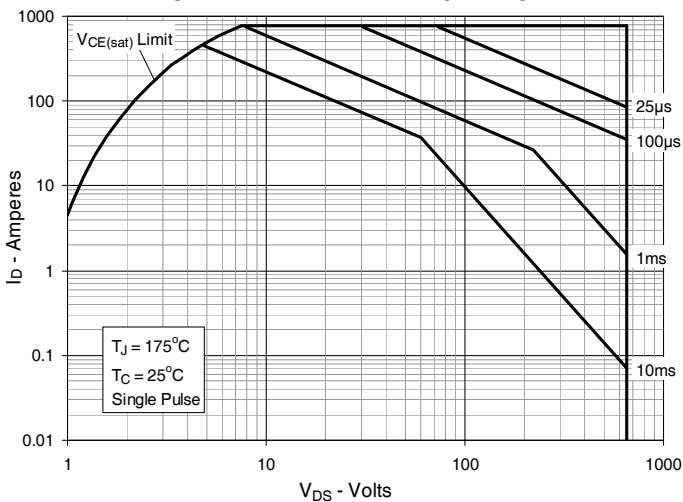
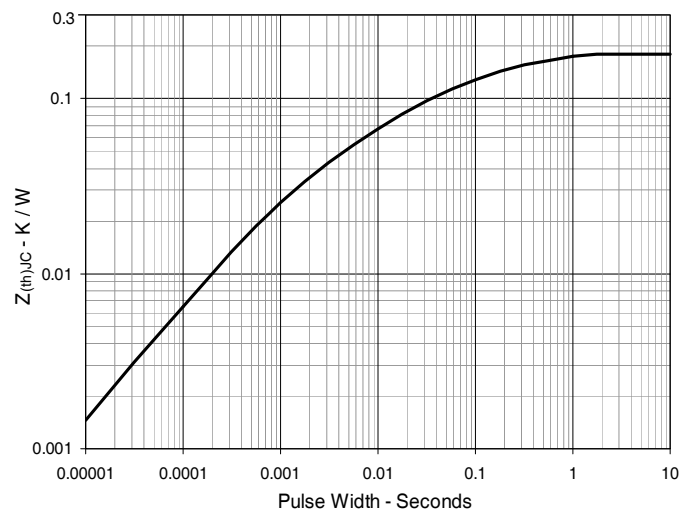
Fig. 12. Maximum Transient Thermal Impedance (IGBT)

Fig. 13. Inductive Switching Energy Loss vs. Gate Resistance

Fig. 14. Inductive Switching Energy Loss vs. Collector Current

Fig. 15. Inductive Switching Energy Loss vs. Junction Temperature

Fig. 16. Inductive Turn-off Switching Times vs. Gate Resistance

Fig. 17. Inductive Turn-off Switching Times vs. Collector Current

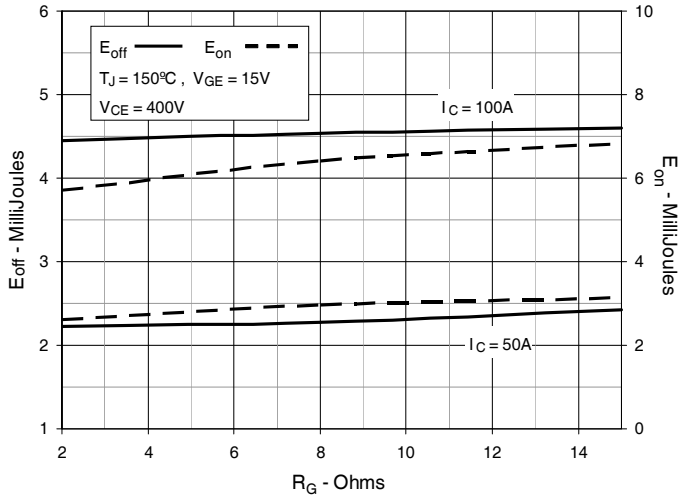
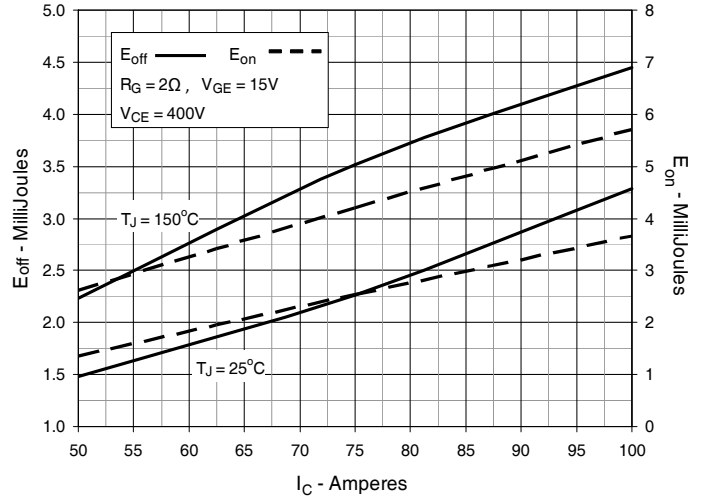
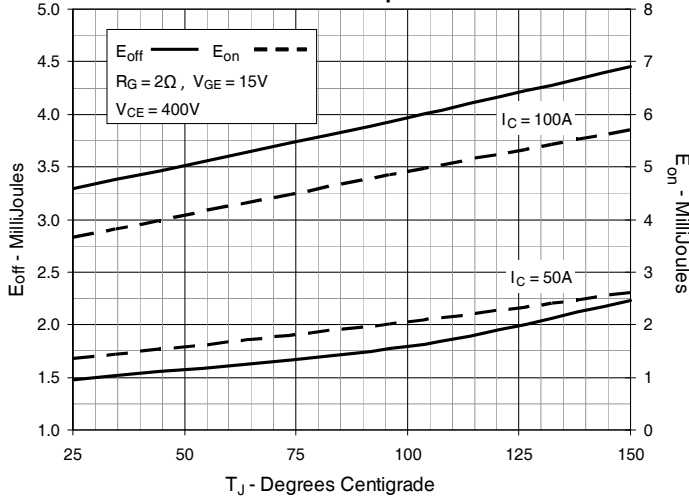
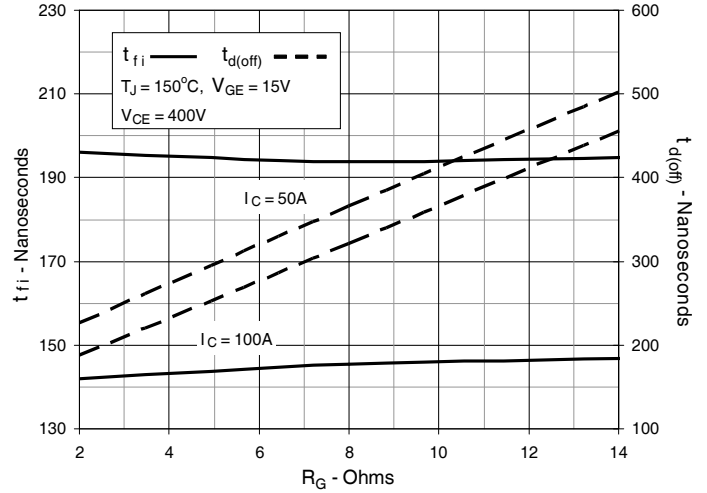
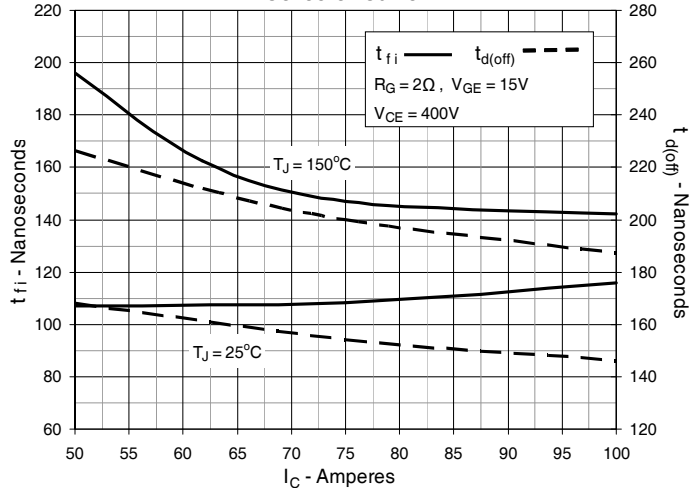
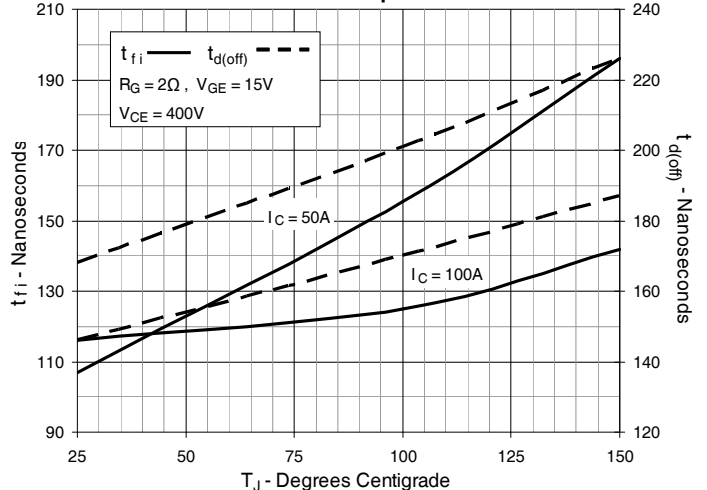
Fig. 18. Inductive Turn-off Switching Times vs. Junction Temperature

Fig. 19. Inductive Turn-on Switching Times vs. Gate Resistance

Fig. 20. Inductive Turn-on Switching Times vs. Collector Current

Fig. 21. Inductive Turn-on Switching Times vs. Junction Temperature

Fig. 22. Diode Forward Characteristics

Fig. 23. Reverse Recovery Charge vs. $-di_F/dt$

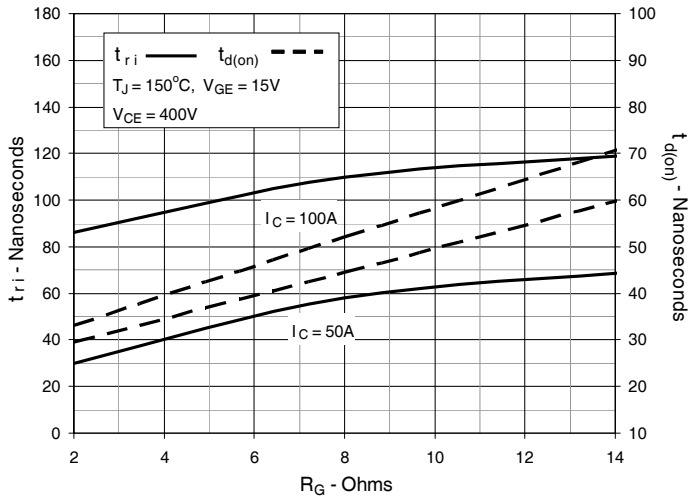
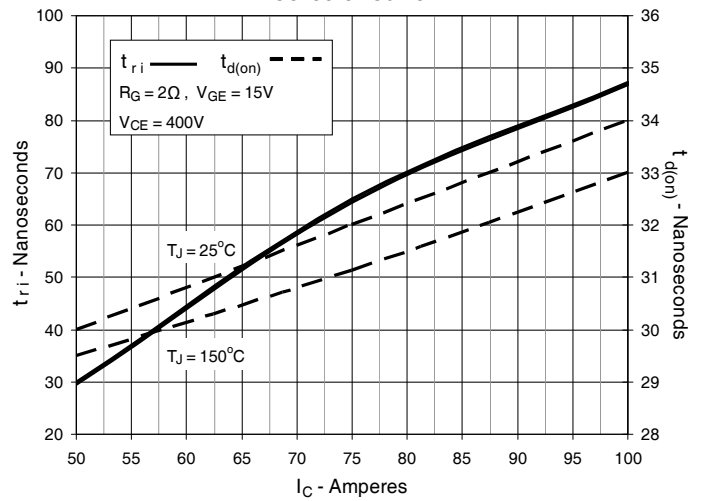
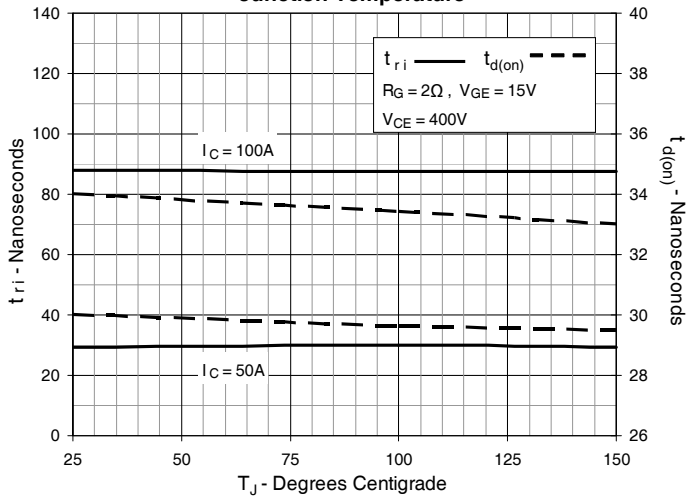
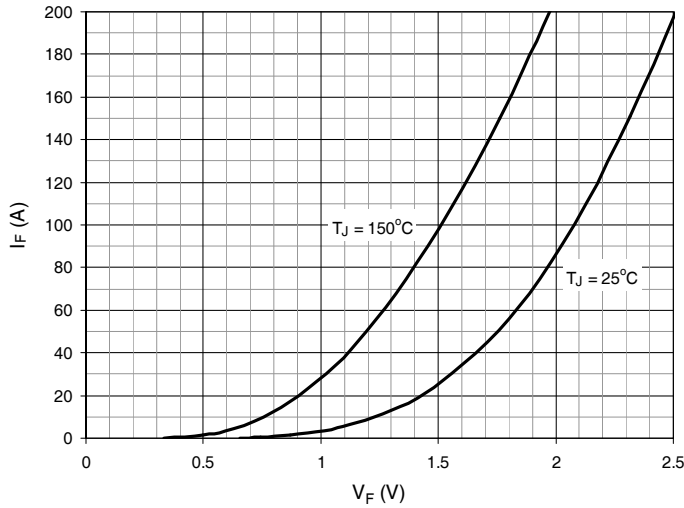
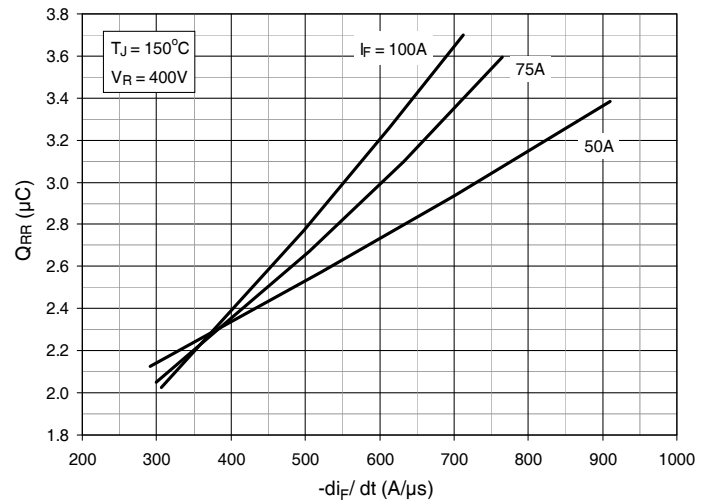
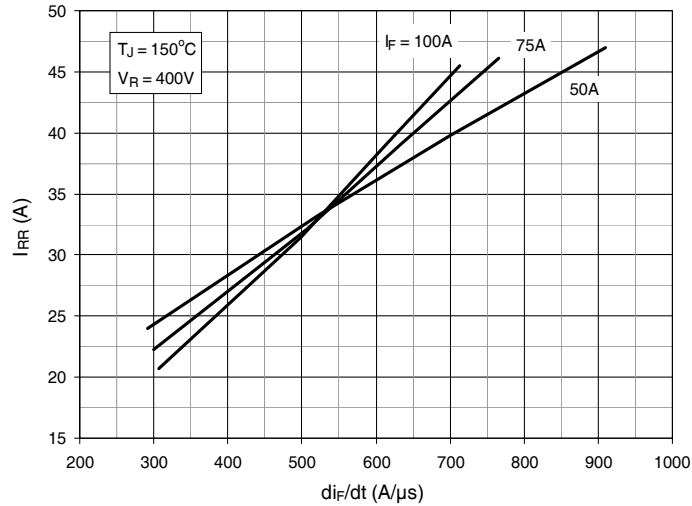
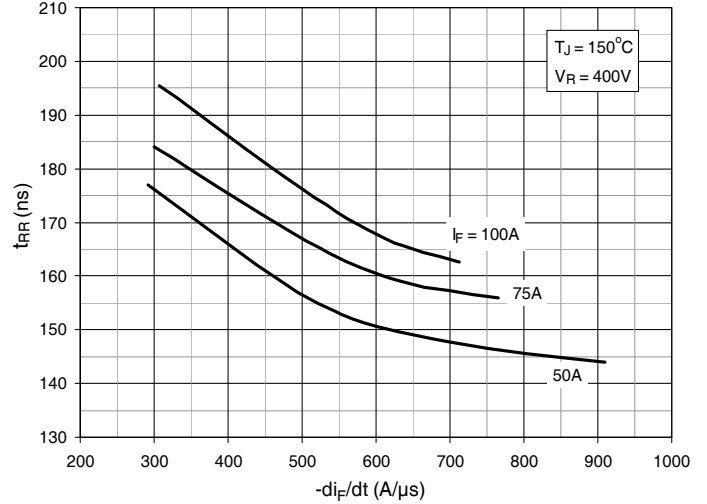
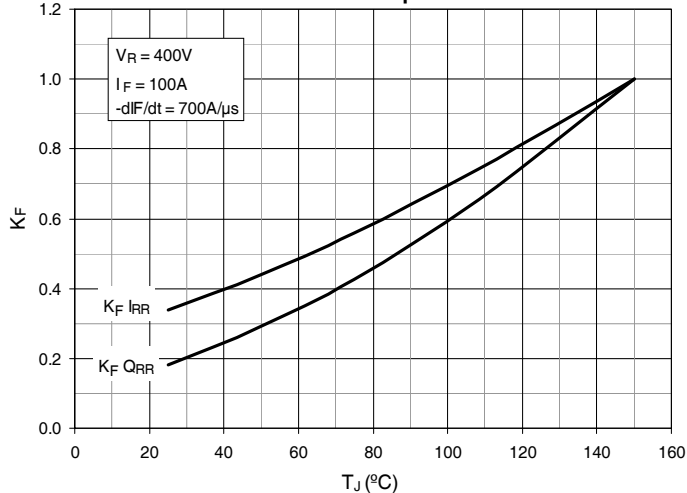
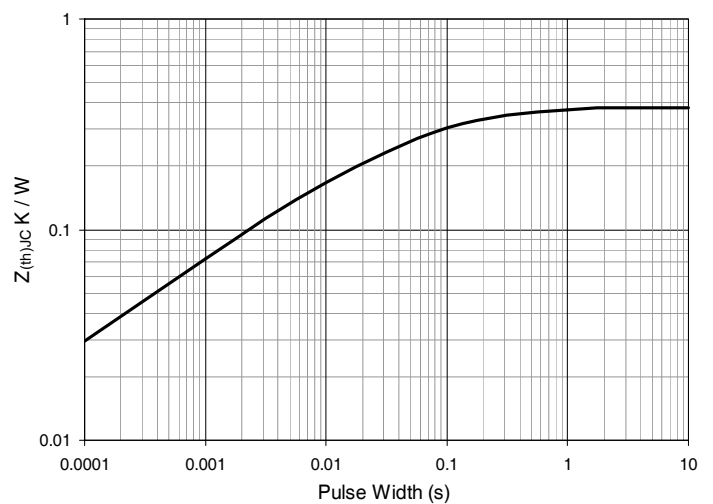
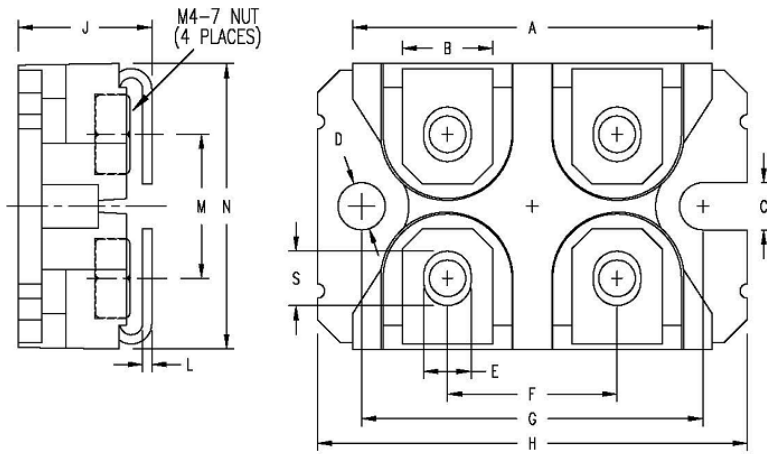
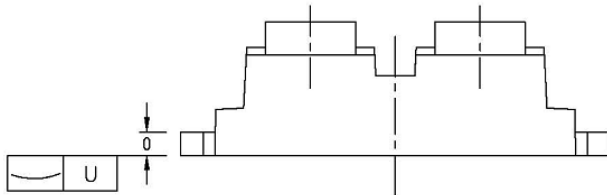
Fig. 24. Reverse Recovery Current vs. $-di_F/dt$

Fig. 25. Reverse Recovery Time vs. $-di_F/dt$

Fig. 26. Dynamic Parameters Q_{RR} , I_{RR} vs. Junction Temperature

Fig. 27. Maximum Transient Thermal Impedance (Diode)

SOT-227B miniBLOC (IXYN)

SYM	INCHES		MILLIMETERS	
	MIN	MAX	MIN	MAX
A	1.224	1.260	31.10	32.00
B	.303	.327	7.70	8.30
C	.161	.173	4.10	4.40
D	.161	.173	4.10	4.40
E	.161	.173	4.10	4.40
F	.587	.598	14.90	15.20
G	1.181	1.201	30.00	30.50
H	1.488	1.508	37.80	38.30
J	.461	.484	11.70	12.30
L	.030	.033	0.75	0.85
M	.492	.512	12.50	13.00
N	.984	1.004	25.00	25.50
O	.075	.087	1.90	2.20
S	.181	.193	4.60	4.90
U	.000	.005	0.00	0.13

- NUT MATERIAL:
 STANDARD - Low carbon steel with Ni plating.
 OPTIONAL - Brass Nut is available.
 PART NUMBER-BN
- ALL METAL SURFACE ARE PRE NI PLATED EXCEPT TRIM AREA.





Disclaimer Notice - Information furnished is believed to be accurate and reliable. However, users should independently evaluate the suitability of and test each product selected for their own applications. Littelfuse products are not designed for, and may not be used in, all applications. Read complete Disclaimer Notice at www.littelfuse.com/disclaimer-electronics.
