

# 1200V XPT™ IGBT GenX3™

## IXYH40N120B3

Extreme Light Punch Through  
IGBT for 5-30 kHz Switching

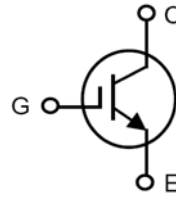

$V_{CES} = 1200V$   
 $I_{C110} = 40A$   
 $V_{CE(sat)} \leq 2.9V$   
 $t_{fi(typ)} = 183ns$

TO-247 AD

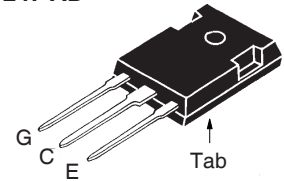

G = Gate      C = Collector  
 E = Emitter    Tab = Collector

Symbol	Test Conditions	Maximum Ratings	
$V_{CES}$	$T_J = 25^\circ C$ to $175^\circ C$	1200	V
$V_{CGR}$	$T_J = 25^\circ C$ to $175^\circ C$ , $R_{GE} = 1M\Omega$	1200	V
$V_{GES}$	Continuous	$\pm 20$	V
$V_{GEM}$	Transient	$\pm 30$	V
$I_{C25}$	$T_C = 25^\circ C$ (Chip Capability)	96	A
$I_{C110}$	$T_C = 110^\circ C$	40	A
$I_{CM}$	$T_C = 25^\circ C$ , 1ms	200	A
$I_A$	$T_C = 25^\circ C$	20	A
$E_{AS}$	$T_C = 25^\circ C$	400	mJ
<b>SSOA</b> <b>(RBSOA)</b>	$V_{GE} = 15V$ , $T_{VJ} = 150^\circ C$ , $R_G = 10\Omega$ Clamped Inductive Load	$I_{CM} = 80$ @ $V_{CE} \leq V_{CES}$	A
$P_C$	$T_C = 25^\circ C$	577	W
$T_J$		-55 ... +175	$^\circ C$
$T_{JM}$		175	$^\circ C$
$T_{stg}$		-55 ... +175	$^\circ C$
$T_L$	Maximum Lead Temperature for Soldering	300	$^\circ C$
$T_{SOLD}$	1.6 mm (0.062in.) from Case for 10s	260	$^\circ C$
$M_d$	Mounting Torque	1.13/10	Nm/lb.in.
<b>Weight</b>		6	g

### Features

- Optimized for 5-30kHz Switching
- Square RBSOA
- Positive Thermal Coefficient of  $V_{ce(sat)}$
- Avalanche Rated
- International Standard Package

### Advantages

- High Power Density
- Low Gate Drive Requirement

### Applications

- Power Inverters
- UPS
- Motor Drives
- SMPS
- PFC Circuits
- Battery Chargers
- Welding Machines
- Lamp Ballasts

Symbol	Test Conditions ( $T_J = 25^\circ C$ , Unless Otherwise Specified)	Characteristic Values		
		Min.	Typ.	Max.
$BV_{CES}$	$I_C = 250\mu A$ , $V_{GE} = 0V$	1200		V
$V_{GE(th)}$	$I_C = 250\mu A$ , $V_{CE} = V_{GE}$	3.0		5.0 V
$I_{CES}$	$V_{CE} = V_{CES}$ , $V_{GE} = 0V$ $T_J = 150^\circ C$			25 $\mu A$ 500 $\mu A$
$I_{GES}$	$V_{CE} = 0V$ , $V_{GE} = \pm 20V$			$\pm 100$ nA
$V_{CE(sat)}$	$I_C = 40A$ , $V_{GE} = 15V$ , Note 1 $T_J = 150^\circ C$		2.4 3.1	2.9 V V

Symbol	Test Conditions ( $T_J = 25^\circ\text{C}$ Unless Otherwise Specified)	Characteristic Values		
		Min.	Typ.	Max.
$g_{fs}$	$I_C = 40\text{A}, V_{CE} = 10\text{V}$ , Note 1	13	22	S
$C_{ies}$	$V_{CE} = 25\text{V}, V_{GE} = 0\text{V}, f = 1\text{MHz}$		1690	pF
$C_{oes}$			117	pF
$C_{res}$			47	pF
$Q_{g(on)}$	$I_C = 40\text{A}, V_{GE} = 15\text{V}, V_{CE} = 0.5 \cdot V_{CES}$		87	nC
$Q_{ge}$			12	nC
$Q_{gc}$			38	nC
$t_{d(on)}$	<b>Inductive load, <math>T_J = 25^\circ\text{C}</math></b> $I_C = 40\text{A}, V_{GE} = 15\text{V}$ $V_{CE} = 0.5 \cdot V_{CES}, R_G = 10\Omega$ Note 2		22	ns
$t_{ri}$			50	ns
$E_{on}$			2.70	mJ
$t_{d(off)}$			177	ns
$t_{fi}$			183	ns
$E_{off}$		1.60	3.00	mJ
$t_{d(on)}$	<b>Inductive load, <math>T_J = 125^\circ\text{C}</math></b> $I_C = 40\text{A}, V_{GE} = 15\text{V}$ $V_{CE} = 0.5 \cdot V_{CES}, R_G = 10\Omega$ Note 2		24	ns
$t_{ri}$			60	ns
$E_{on}$			5.25	mJ
$t_{d(off)}$			205	ns
$t_{fi}$			206	ns
$E_{off}$		2.05	mJ	
$R_{thJC}$			0.26	$^\circ\text{C}/\text{W}$
$R_{thCS}$		0.21		$^\circ\text{C}/\text{W}$

TO-247 (IXYH) Outline

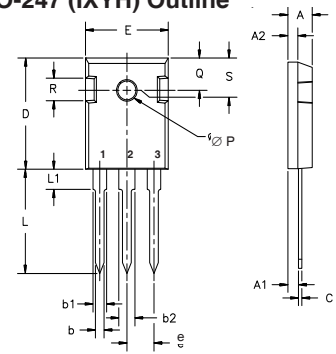

Terminals: 1 - Gate 2 - Collector  
3 - Emitter

Dim.	Millimeter		Inches	
	Min.	Max.	Min.	Max.
A	4.7	5.3	.185	.209
A <sub>1</sub>	2.2	2.54	.087	.102
A <sub>2</sub>	2.2	2.6	.059	.098
b	1.0	1.4	.040	.055
b <sub>1</sub>	1.65	2.13	.065	.084
b <sub>2</sub>	2.87	3.12	.113	.123
C	.4	.8	.016	.031
D	20.80	21.46	.819	.845
E	15.75	16.26	.610	.640
e	5.20	5.72	0.205	0.225
L	19.81	20.32	.780	.800
L1		4.50		.177
∅P	3.55	3.65	.140	.144
Q	5.89	6.40	0.232	0.252
R	4.32	5.49	.170	.216
S	6.15	BSC	.242	BSC

Notes:

1. Pulse test,  $t \leq 300\mu\text{s}$ , duty cycle,  $d \leq 2\%$ .
2. Switching times & energy losses may increase for higher  $V_{CE}$  (clamp),  $T_J$  or  $R_G$ .

IXYS Reserves the Right to Change Limits, Test Conditions, and Dimensions.

IXYS MOSFETs and IGBTs are covered by one or more of the following U.S. patents:	4,835,592	4,931,844	5,049,961	5,237,481	6,162,665	6,404,065 B1	6,683,344	6,727,585	7,005,734 B2	7,157,338B2
	4,860,072	5,017,508	5,063,307	5,381,025	6,259,123 B1	6,534,343	6,710,405 B2	6,759,692	7,063,975 B2	
	4,881,106	5,034,796	5,187,117	5,486,715	6,306,728 B1	6,583,505	6,710,463	6,771,478 B2	7,071,537	

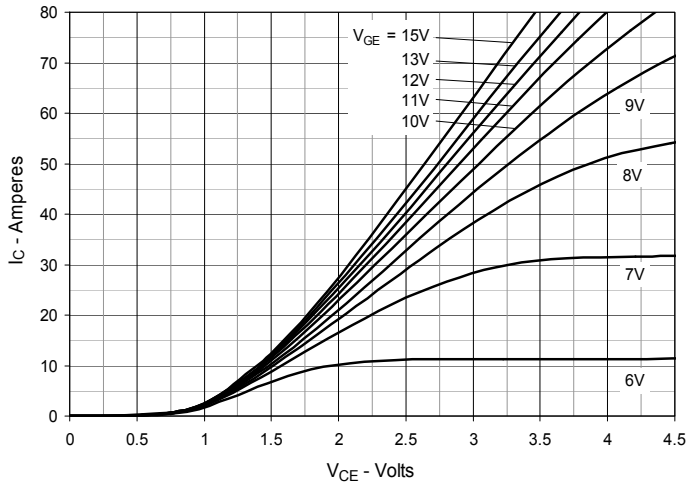
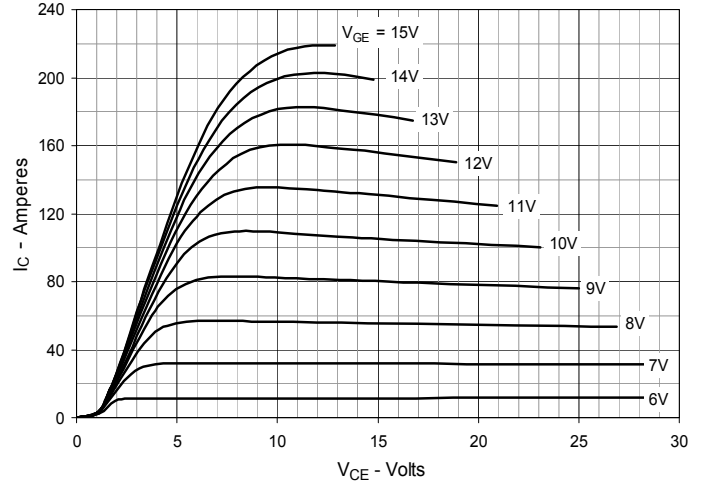
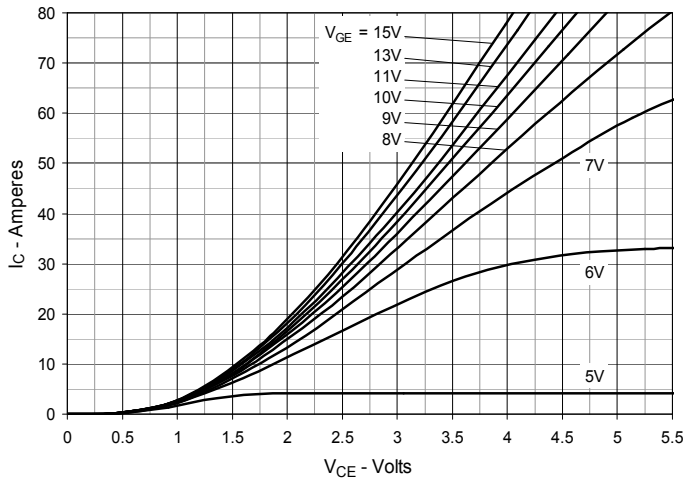
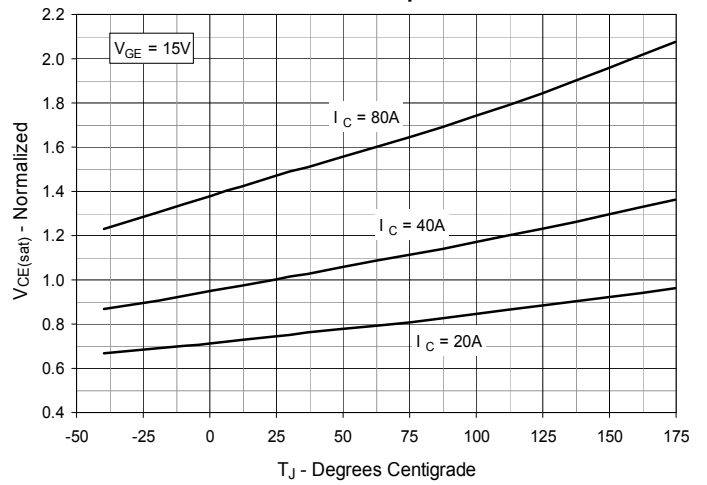
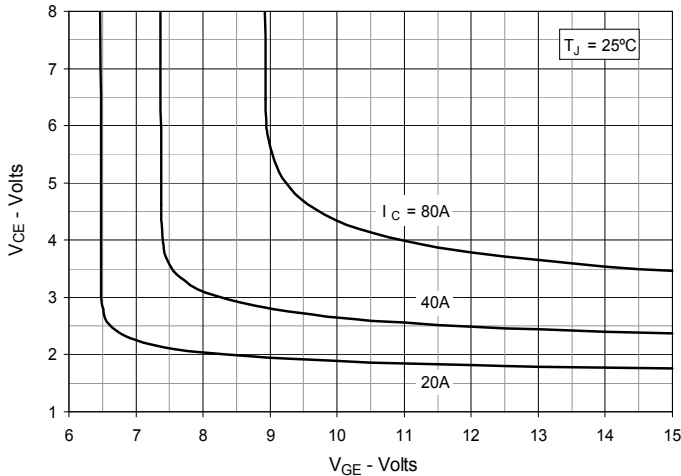
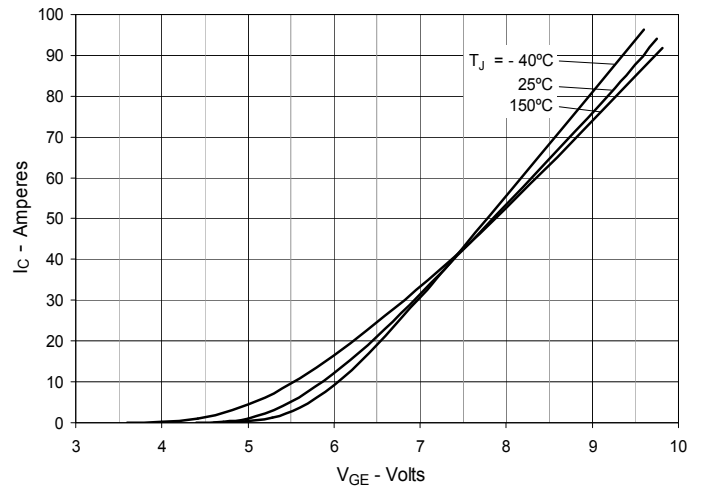
**Fig. 1. Output Characteristics @  $T_J = 25^\circ\text{C}$** 

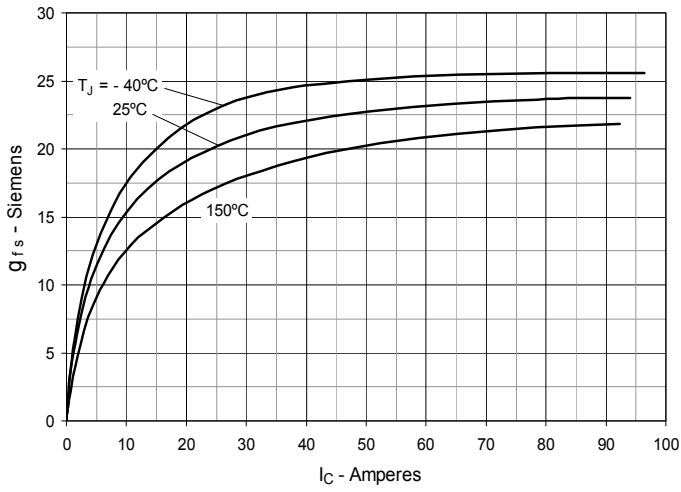
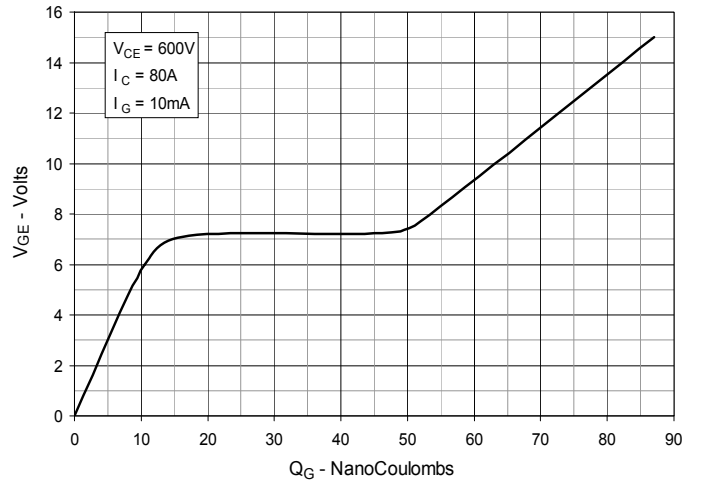
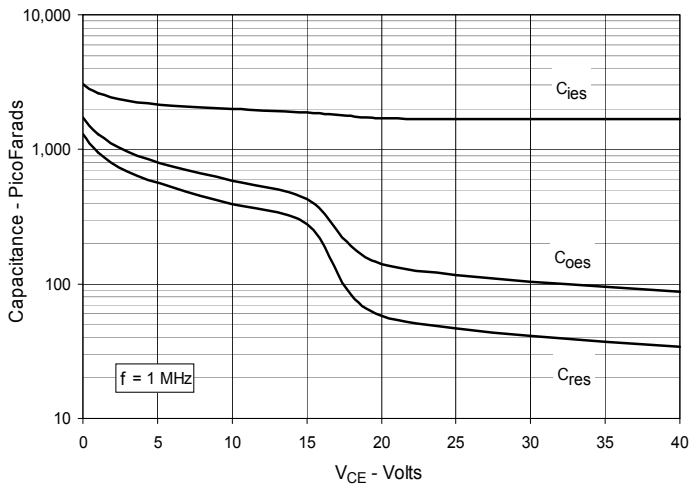
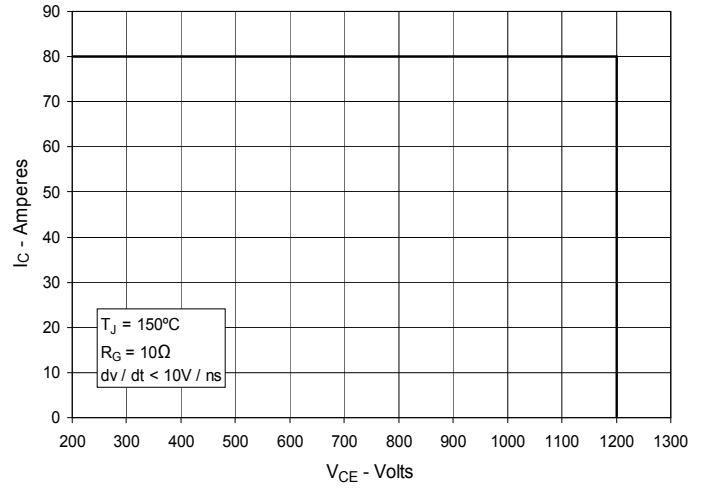
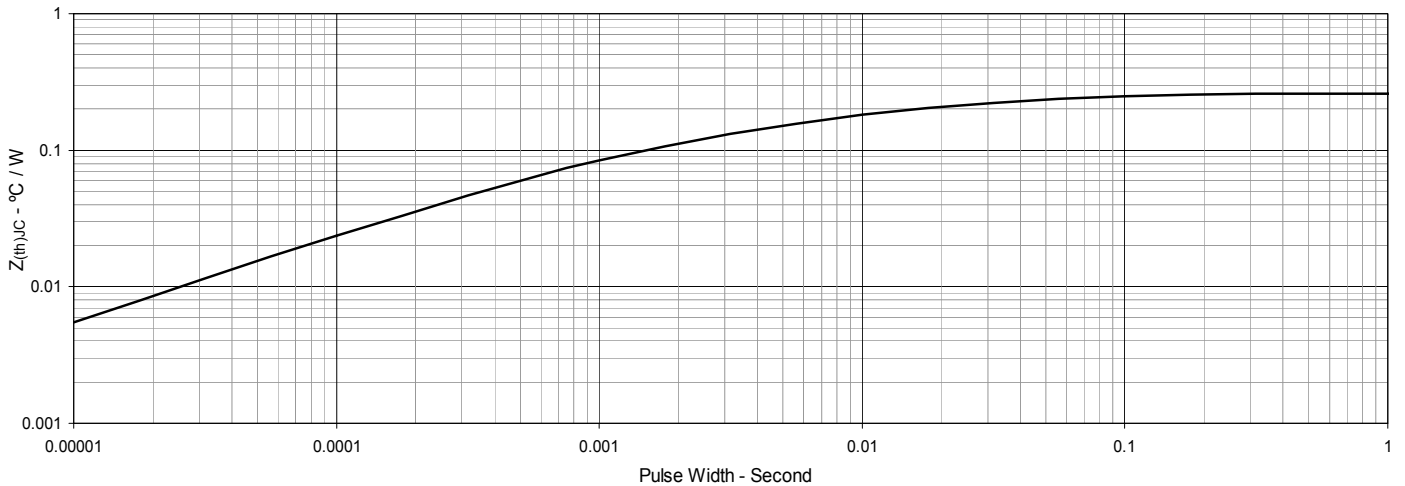
**Fig. 2. Extended Output Characteristics @  $T_J = 25^\circ\text{C}$** 

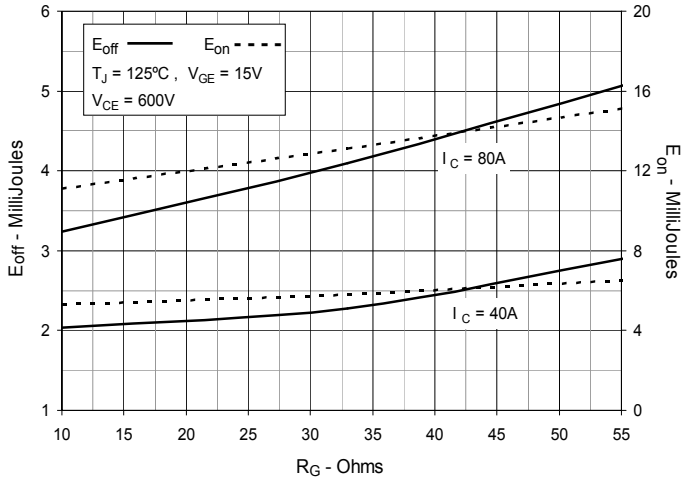
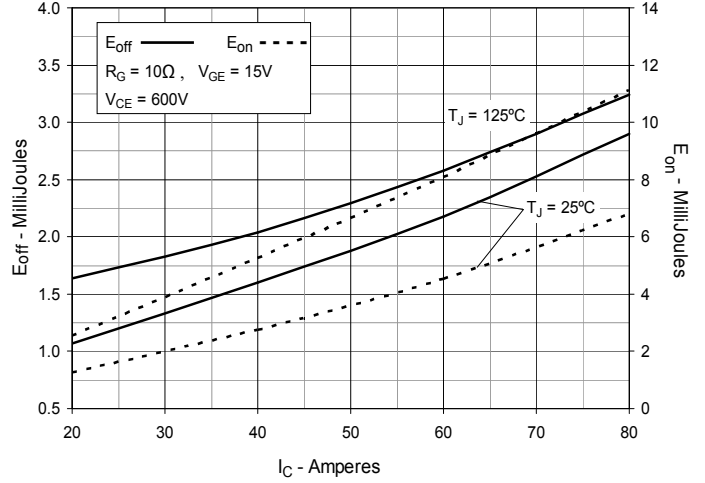
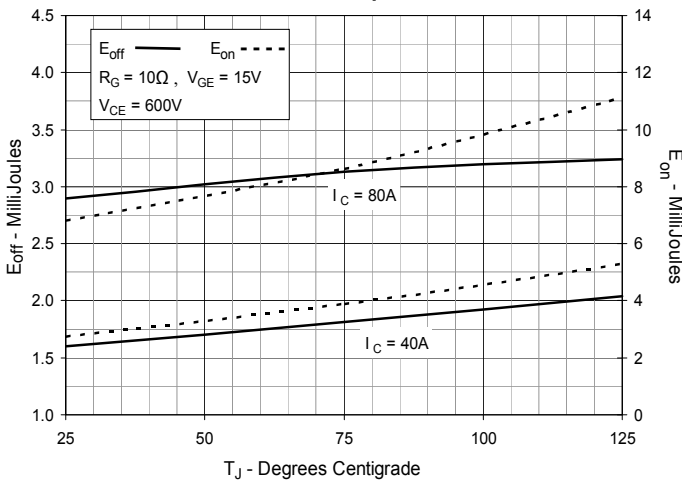
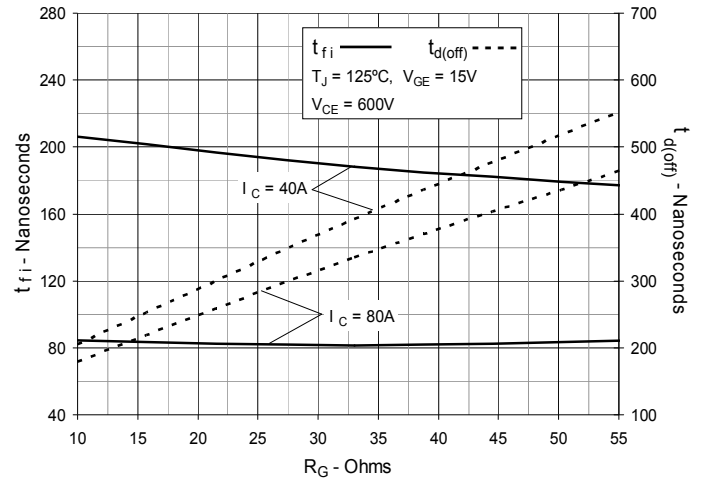
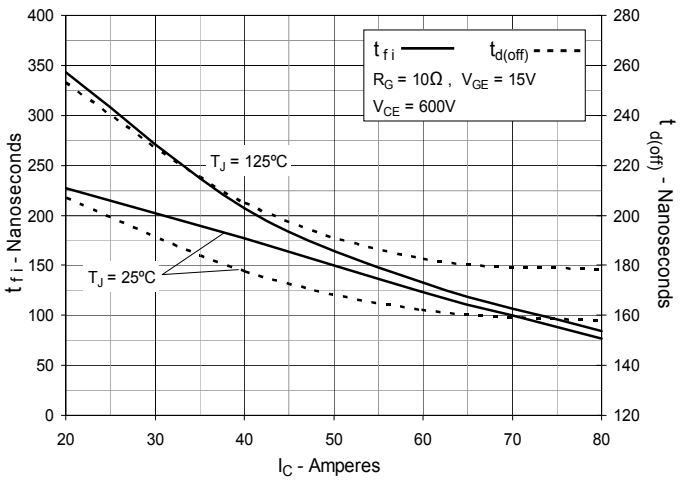
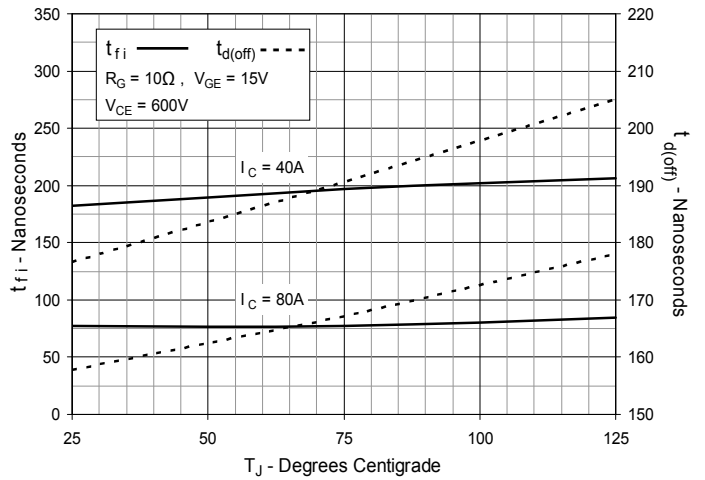
**Fig. 3. Output Characteristics @  $T_J = 150^\circ\text{C}$** 

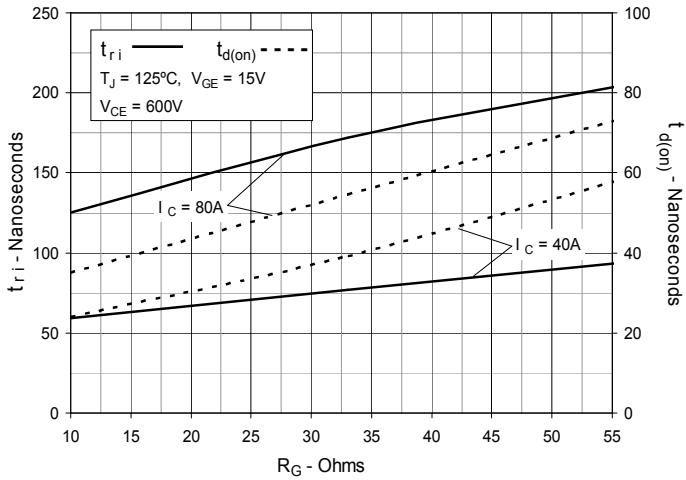
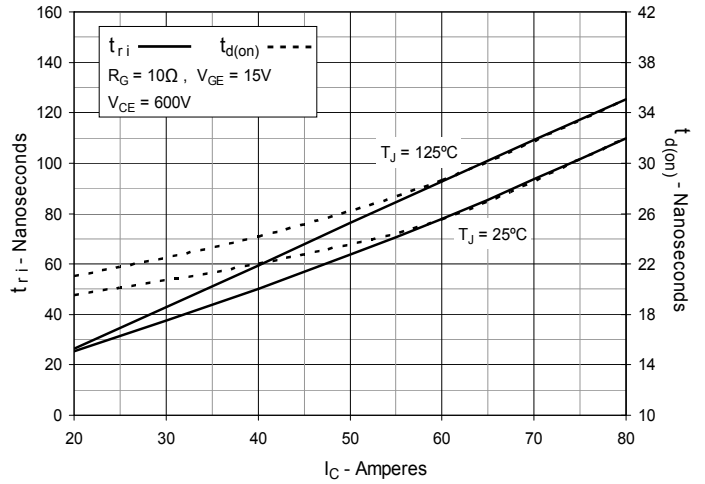
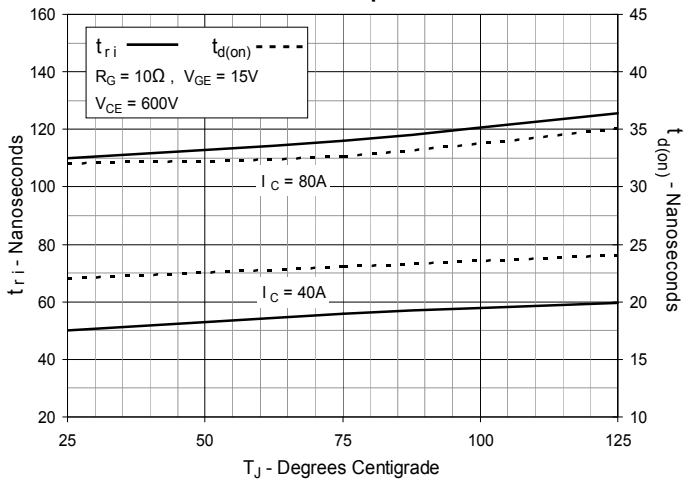
**Fig. 4. Dependence of  $V_{CE(sat)}$  on Junction Temperature**

**Fig. 5. Collector-to-Emitter Voltage vs. Gate-to-Emitter Voltage**

**Fig. 6. Input Admittance**

**Fig. 7. Transconductance**

**Fig. 8. Gate Charge**

**Fig. 9. Capacitance**

**Fig. 10. Reverse-Bias Safe Operating Area**

**Fig. 11. Maximum Transient Thermal Impedance**

**Fig. 12. Inductive Switching Energy Loss vs. Gate Resistance**

**Fig. 13. Inductive Switching Energy Loss vs. Collector Current**

**Fig. 14. Inductive Switching Energy Loss vs. Junction Temperature**

**Fig. 15. Inductive Turn-off Switching Times vs. Gate Resistance**

**Fig. 16. Inductive Turn-off Switching Times vs. Collector Current**

**Fig. 17. Inductive Turn-off Switching Times vs. Junction Temperature**

**Fig. 18. Inductive Turn-on Switching Times vs. Gate Resistance**

**Fig. 19. Inductive Turn-on Switching Times vs. Collector Current**

**Fig. 20. Inductive Turn-on Switching Times vs. Junction Temperature**



---

Disclaimer Notice - Information furnished is believed to be accurate and reliable. However, users should independently evaluate the suitability of and test each product selected for their own applications. Littelfuse products are not designed for, and may not be used in, all applications. Read complete Disclaimer Notice at [www.littelfuse.com/disclaimer-electronics](http://www.littelfuse.com/disclaimer-electronics).