

**XPT™ 750V IGBT  
GenX4™ w/Diode**
**IXXX100N75B4H1  
IXXK100N75B4H1**

$$V_{CES} = 750V$$

$$I_{C110} = 100A$$

$$V_{CE(sat)} \leq 2.10V$$

$$t_{fi(typ)} = 110ns$$

Extreme Light Punch Through  
IGBT for 10-30kHz Switching

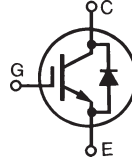

Symbol	Test Conditions	Maximum Ratings	
$V_{CES}$	$T_J = 25^\circ C$ to $175^\circ C$	750	V
$V_{CGR}$	$T_J = 25^\circ C$ to $175^\circ C$ , $R_{GE} = 1M\Omega$	750	V
$V_{GES}$	Continuous	$\pm 20$	V
$V_{GEM}$	Transient	$\pm 30$	V
$I_{C25}$	$T_C = 25^\circ C$ (Chip Capability)	240	A
$I_{LRMS}$	Terminal Current Limit	160	A
$I_{C110}$	$T_C = 110^\circ C$	100	A
$I_{F110}$	$T_C = 110^\circ C$	120	A
$I_{CM}$	$T_C = 25^\circ C$ , 1ms	580	A
<b>SSOA (RBSOA)</b>	$V_{GE} = 15V$ , $T_{VJ} = 150^\circ C$ , $R_G = 2\Omega$ Clamped Inductive Load	$I_{CM} = 200$ $V_{CE} \leq V_{CES}$	A
<b><math>T_{SC}</math> (SCSOA)</b>	$V_{GE} = 15V$ , $T_J = 150^\circ C$ , $R_G = 20\Omega$ , $V_{CE} = 400V$ , Non-Repetitive	10	$\mu s$
<b><math>P_C</math></b>	$T_C = 25^\circ C$	880	W
<b><math>T_J</math></b>		-55 ... +175	$^\circ C$
<b><math>T_{JM}</math></b>		175	$^\circ C$
<b><math>T_{stg}</math></b>		-55 ... +175	$^\circ C$
<b><math>T_L</math></b>	Maximum Lead Temperature for Soldering	300	$^\circ C$
<b><math>T_{SOLD}</math></b>	1.6 mm (0.062in.) from Case for 10s	260	$^\circ C$
<b><math>M_d</math></b>	Mounting Torque (TO-264)	1.13/10	Nm/lb.in
<b><math>F_C</math></b>	Mounting Force (PLUS247)	20..120 / 4.5..27	N/lb
<b>Weight</b>	PLUS247	6	g
	TO-264	10	g

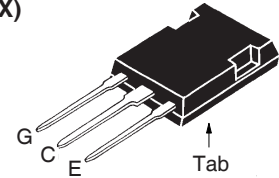
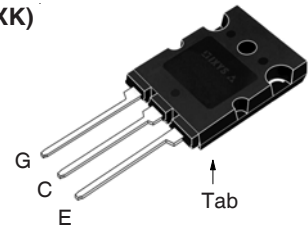
**PLUS247  
(IXXX)**

**TO-264  
(IXXK)**

G = Gate      C = Collector  
E = Emitter    Tab = Collector

**Features**

- Optimized for 10-30kHz Switching
- Square RBSOA
- High Current Handling Capability
- International Standard Packages

**Advantages**

- High Power Density
- Low Gate Drive Requirement

**Applications**

- Power Inverters
- UPS
- Motor Drives
- SMPS
- PFC Circuits
- Battery Chargers
- Welding Machines
- Lamp Ballasts
- High Frequency Power Inverters

Symbol	Test Conditions ( $T_J = 25^\circ C$ , Unless Otherwise Specified)	Characteristic Values		
		Min.	Typ.	Max.
<b><math>BV_{CES}</math></b>	$I_C = 250\mu A$ , $V_{GE} = 0V$	750		V
<b><math>V_{GE(th)}</math></b>	$I_C = 250\mu A$ , $V_{CE} = V_{GE}$	4.0		6.5 V
<b><math>I_{CES}</math></b>	$V_{CE} = V_{CES}$ , $V_{GE} = 0V$ $T_J = 125^\circ C$			25 $\mu A$ 5 mA
<b><math>I_{GES}</math></b>	$V_{CE} = 0V$ , $V_{GE} = \pm 20V$			$\pm 100$ nA
<b><math>V_{CE(sat)}</math></b>	$I_C = 100A$ , $V_{GE} = 15V$ , Note 1 $T_J = 150^\circ C$		1.74 2.07	2.10 V V

**Symbol Test Conditions**
 $(T_J = 25^\circ\text{C Unless Otherwise Specified})$ 
**Characteristic Values**

		Min.	Typ.	Max.	
$g_{fs}$	$I_C = 60A, V_{CE} = 10V, \text{Note 1}$	32	54		S
$C_{ies}$	$V_{CE} = 25V, V_{GE} = 0V, f = 1\text{MHz}$		4420		pF
$C_{oes}$			415		pF
$C_{res}$			98		pF
$Q_{g(on)}$	$I_C = 100A, V_{GE} = 15V, V_{CE} = 0.5 \cdot V_{CES}$		165		nC
$Q_{ge}$			43		nC
$Q_{gc}$			62		nC
$t_{d(on)}$	<b>Inductive load, <math>T_J = 25^\circ\text{C}</math></b> $I_C = 50A, V_{GE} = 15V$ $V_{CE} = 400V, R_G = 2\Omega$ Note 2		27		ns
$t_{ri}$			44		ns
$E_{on}$			2.75		mJ
$t_{d(off)}$			155		ns
$t_{fi}$			110		ns
$E_{off}$			1.75		mJ
$t_{d(on)}$	<b>Inductive load, <math>T_J = 150^\circ\text{C}</math></b> $I_C = 50A, V_{GE} = 15V$ $V_{CE} = 400V, R_G = 2\Omega$ Note 2		24		ns
$t_{ri}$			43		ns
$E_{on}$			4.00		mJ
$t_{d(off)}$			190		ns
$t_{fi}$			236		ns
$E_{off}$			3.00		mJ
$R_{thJC}$				0.17	$^\circ\text{C/W}$
$R_{thCS}$		0.15			$^\circ\text{C/W}$

**Reverse Diode (FRD)**
**Symbol Test Conditions**
 $(T_J = 25^\circ\text{C Unless Otherwise Specified})$ 
**Characteristic Values**

		Min.	Typ.	Max.	
$V_F$	$I_F = 100A, V_{GE} = 0V, \text{Note 1}$		1.5	2.2	V
			1.7		V
$I_{RM}$	$I_F = 100A, V_{GE} = 0V,$ $-di_F/dt = 500A/\mu\text{s}, V_R = 400V$		37		A
$t_{rr}$			245		ns
$R_{thJC}$				0.20	$^\circ\text{C/W}$

**Notes:**

1. Pulse test,  $t \leq 300\mu\text{s}$ , duty cycle,  $d \leq 2\%$ .
2. Switching times & energy losses may increase for higher  $V_{CE}$  (Clamp),  $T_J$  or  $R_G$ .

**ADVANCE TECHNICAL INFORMATION**

The product presented herein is under development. The Technical Specifications offered are derived from a subjective evaluation of the design, based upon prior knowledge and experience, and constitute a "considered reflection" of the anticipated result. IXYS reserves the right to change limits, test conditions, and dimensions without notice.

**IXYS Reserves the Right to Change Limits, Test Conditions, and Dimensions.**

IXYS MOSFETs and IGBTs are covered 4,835,592 4,931,844 5,049,961 5,237,481 6,162,665 6,404,065 B1 6,683,344 6,727,585 7,005,734 B2 7,157,338B2  
 by one or more of the following U.S. patents: 4,860,072 5,017,508 5,063,307 5,381,025 6,259,123 B1 6,534,343 6,710,405 B2 6,759,692 7,063,975 B2  
 4,881,106 5,034,796 5,187,117 5,486,715 6,306,728 B1 6,583,505 6,710,463 6,771,478 B2 7,071,537

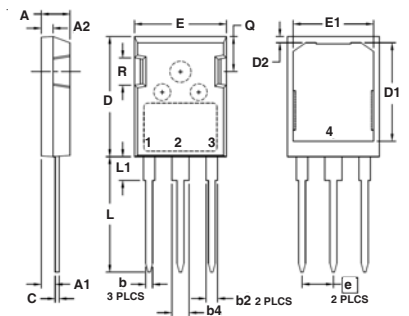
**PLUS247™ Outline**

Terminals: 1 - Gate  
 2,4 - Collector  
 3 - Emitter

SYM	INCHES		MILLIMETERS	
	MIN	MAX	MIN	MAX
A	.190	.205	4.83	5.21
A1	.090	.100	2.29	2.54
A2	.075	.085	1.91	2.16
b	.045	.055	1.14	1.40
b2	.075	.087	1.91	2.20
b4	.115	.126	2.92	3.20
C	.024	.031	0.61	0.80
D	.819	.840	20.80	21.34
D1	.650	.690	16.51	17.53
D2	.035	.050	0.89	1.27
E	.620	.635	15.75	16.13
E1	.520	.560	13.08	14.22
e	.215 BSC		5.45 BSC	
L	.780	.810	19.81	20.57
L1	.150	.170	3.81	4.32
Q	.220	.244	5.59	6.20
R	.170	.190	4.32	4.83

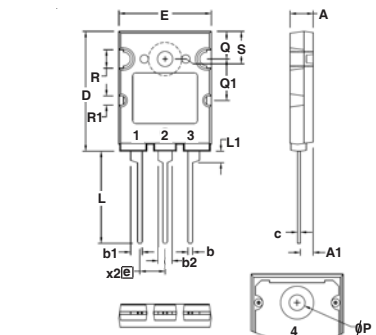
**TO-264 Outline**

Terminals: 1 = Gate  
 2,4 = Collector  
 3 = Emitter

SYM	INCHES		MILLIMETERS	
	MIN	MAX	MIN	MAX
A	.185	.209	4.70	5.30
A1	.102	.118	2.60	3.00
b	.035	.049	0.90	1.25
b1	.091	.106	2.30	2.70
b2	.110	.126	2.80	3.20
c	.020	.033	0.50	0.85
D	1.012	1.035	25.70	26.30
E	.776	.799	19.70	20.30
e	.215BSC		5.46 BSC	
L	.768	.807	19.50	20.50
L1	.091	.106	2.30	2.70
phi P	.122	.138	3.10	3.50
Q	.228	.244	5.80	6.20
Q1	.346	.362	8.80	9.20
phi R	.150	.165	3.80	4.20
phi R1	.071	.087	1.80	2.20
S	.228	.244	5.80	6.20

**Fig. 1. Output Characteristics @  $T_J = 25^\circ\text{C}$**

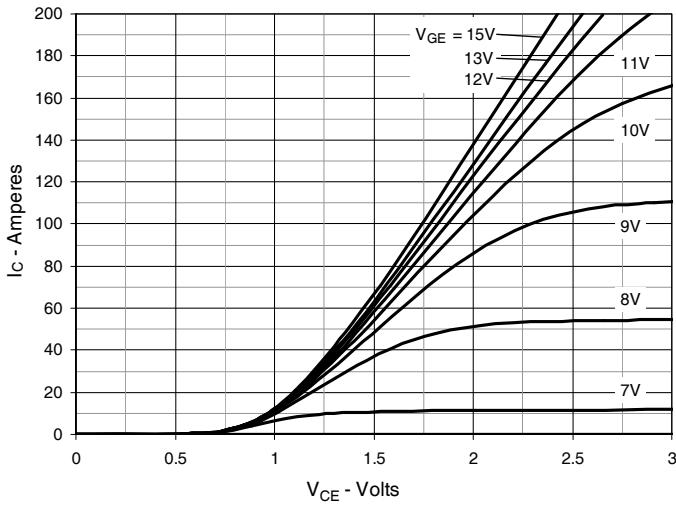

**Fig. 2. Extended Output Characteristics @  $T_J = 25^\circ\text{C}$**

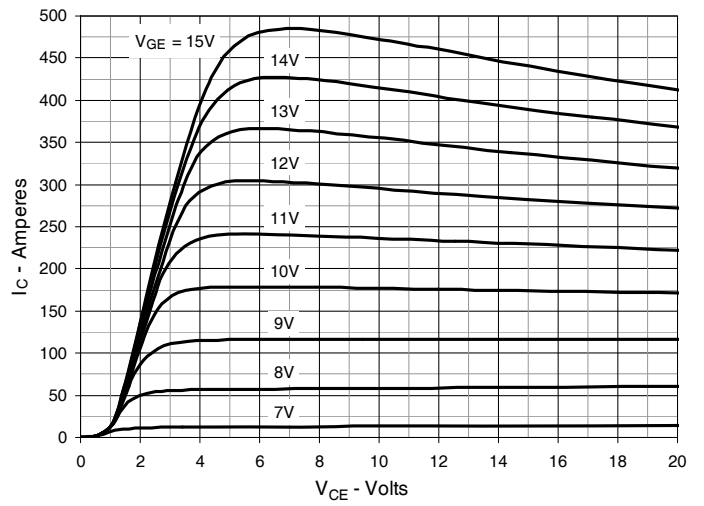

**Fig. 3. Output Characteristics @  $T_J = 150^\circ\text{C}$**

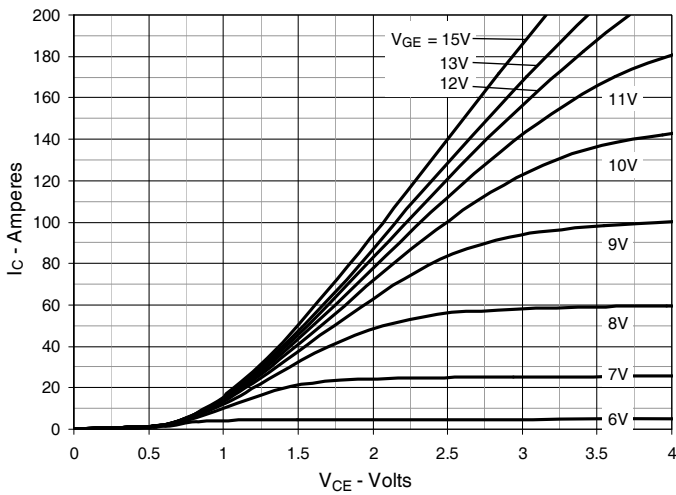

**Fig. 4. Dependence of  $V_{CE(sat)}$  on Junction Temperature**

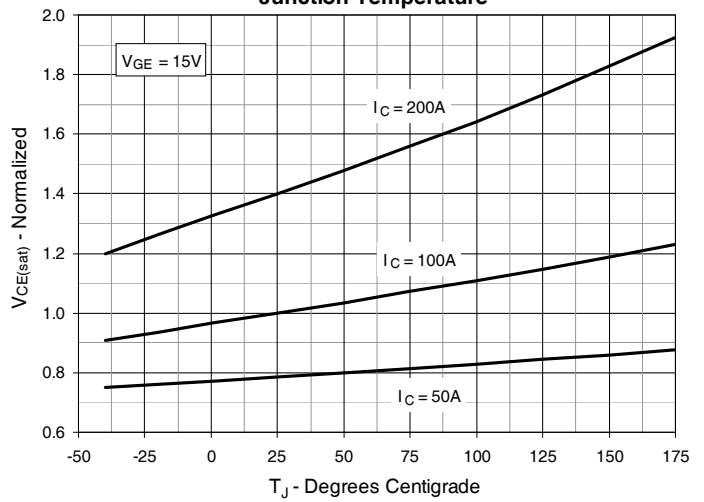

**Fig. 5. Collector-to-Emitter Voltage vs. Gate-to-Emitter Voltage**

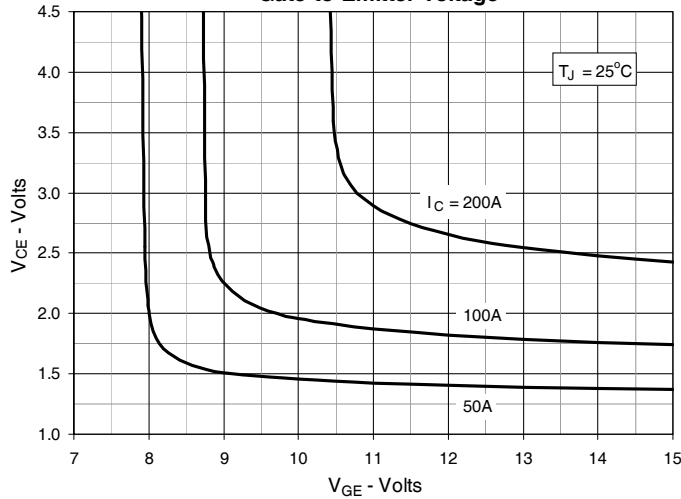

**Fig. 6. Input Admittance**

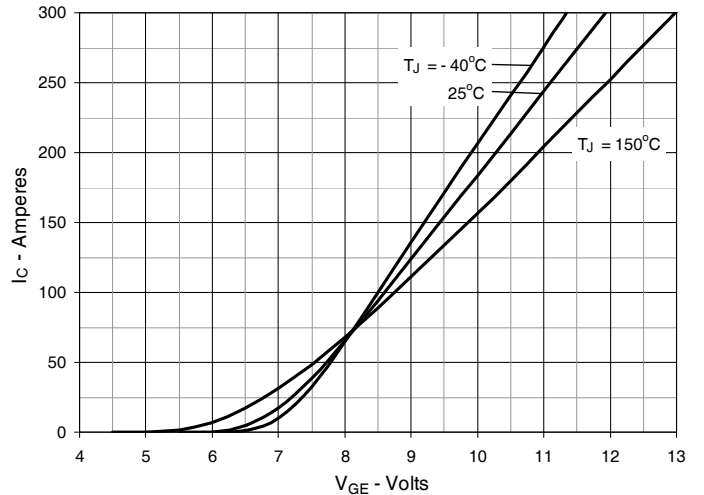

**Fig. 7. Transconductance**

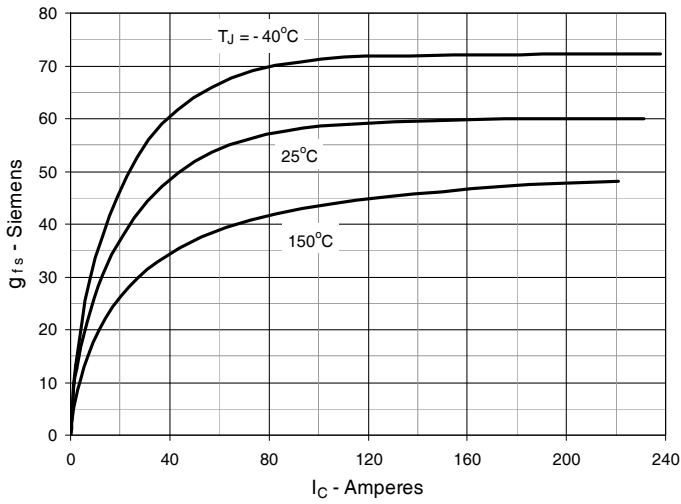

**Fig. 8. Gate Charge**

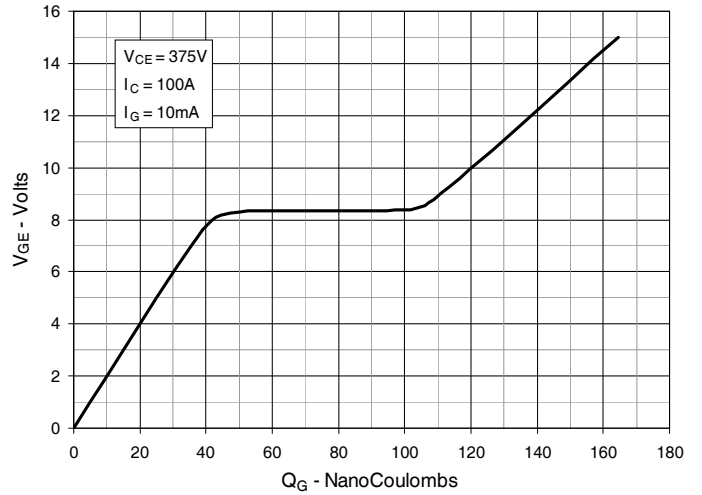

**Fig. 9. Capacitance**

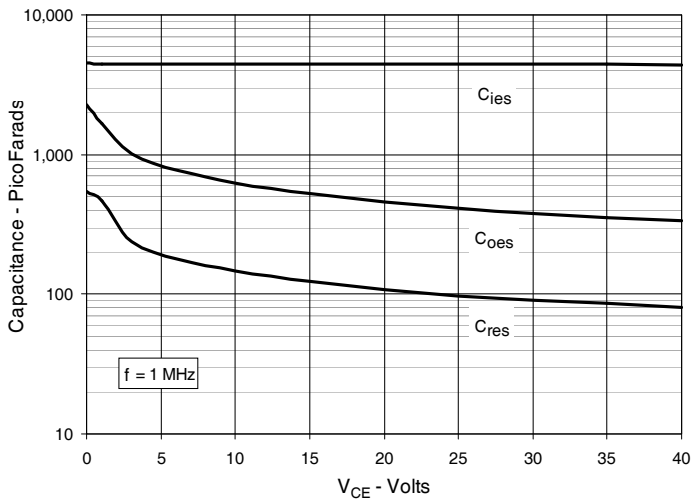

**Fig. 10. Reverse-Bias Safe Operating Area**

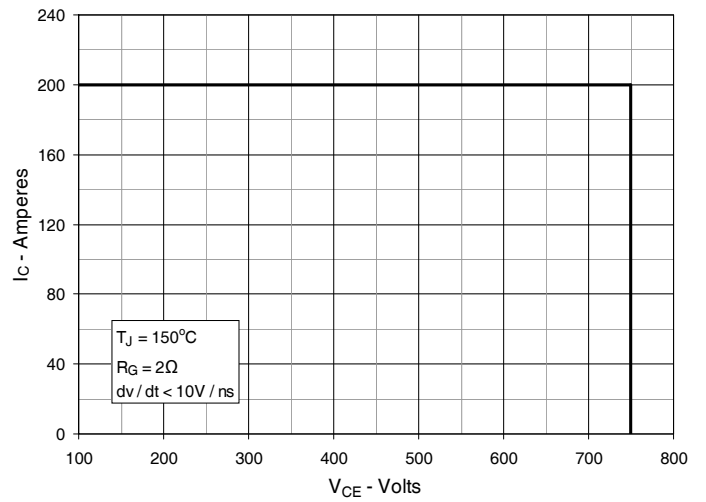

**Fig. 11. Maximum Transient Thermal Impedance (IGBT)**

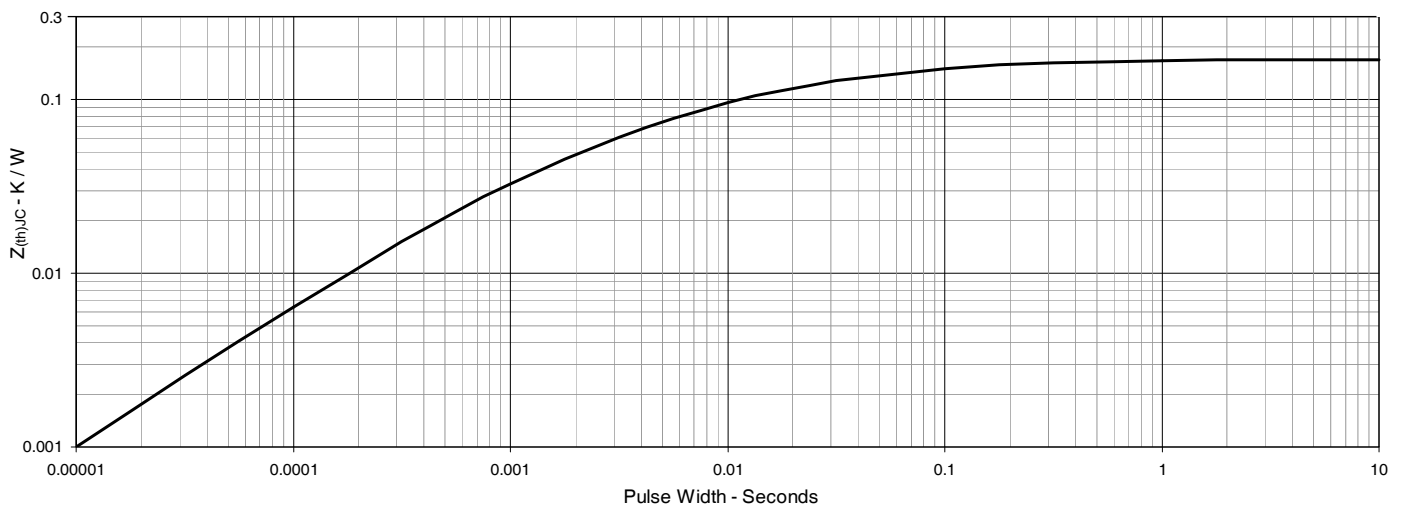

**Fig. 12. Inductive Switching Energy Loss vs. Gate Resistance**

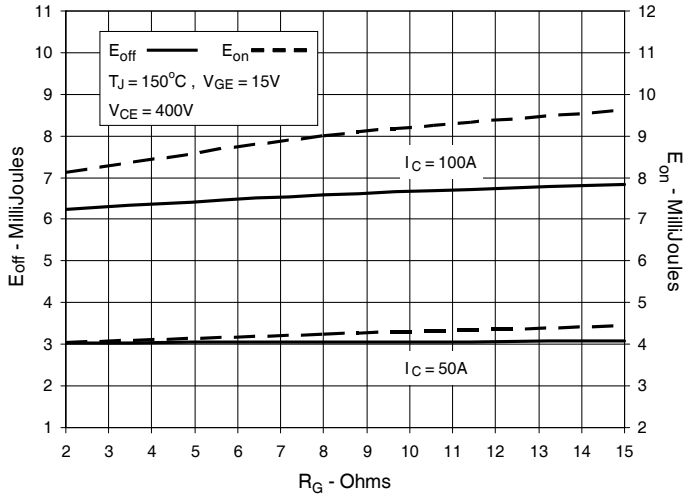

**Fig. 13. Inductive Switching Energy Loss vs. Collector Current**

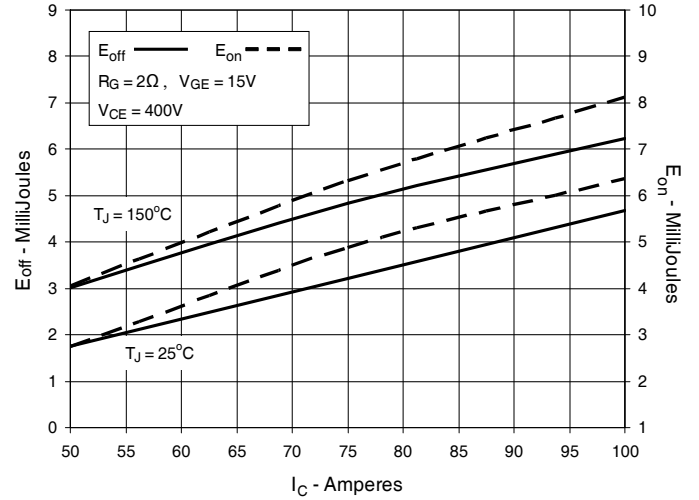

**Fig. 14. Inductive Switching Energy Loss vs. Junction Temperature**

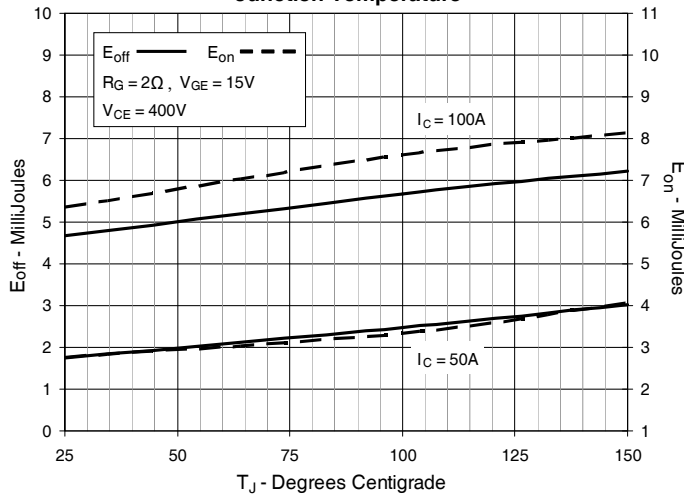

**Fig. 15. Inductive Turn-off Switching Times vs. Gate Resistance**

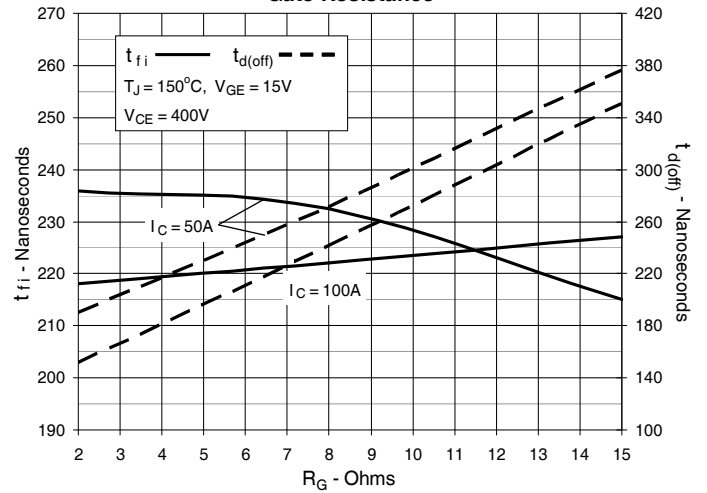

**Fig. 16. Inductive Turn-off Switching Times vs. Collector Current**

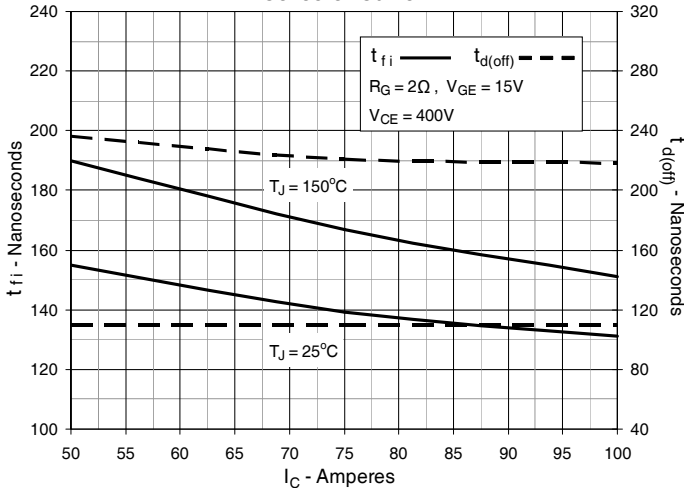

**Fig. 17. Inductive Turn-off Switching Times vs. Junction Temperature**

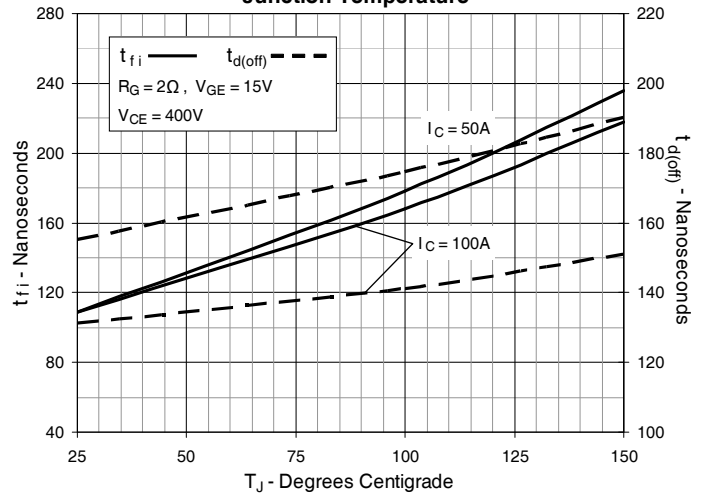

**Fig. 18. Inductive Turn-on Switching Times vs. Gate Resistance**

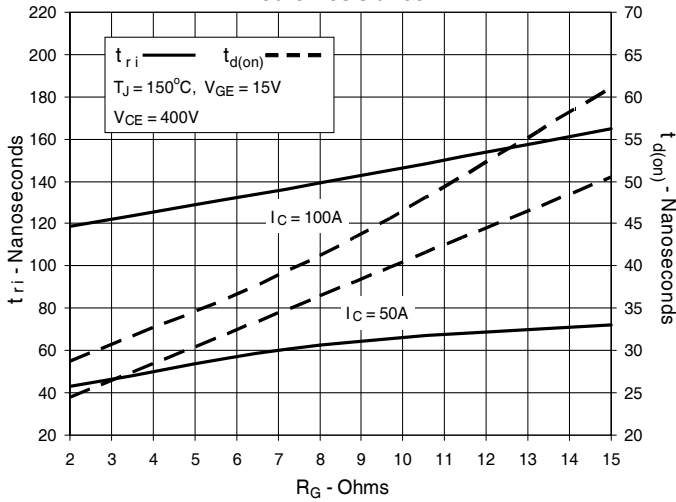

**Fig. 19. Inductive Turn-on Switching Times vs. Collector Current**

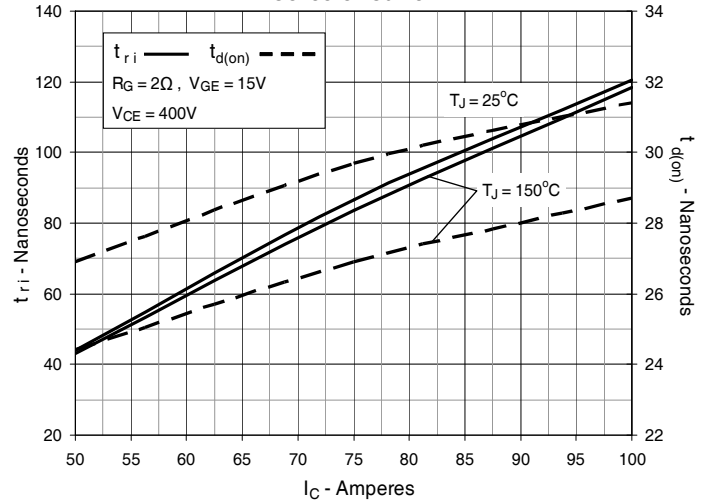

**Fig. 20. Inductive Turn-on Switching Times vs. Junction Temperature**

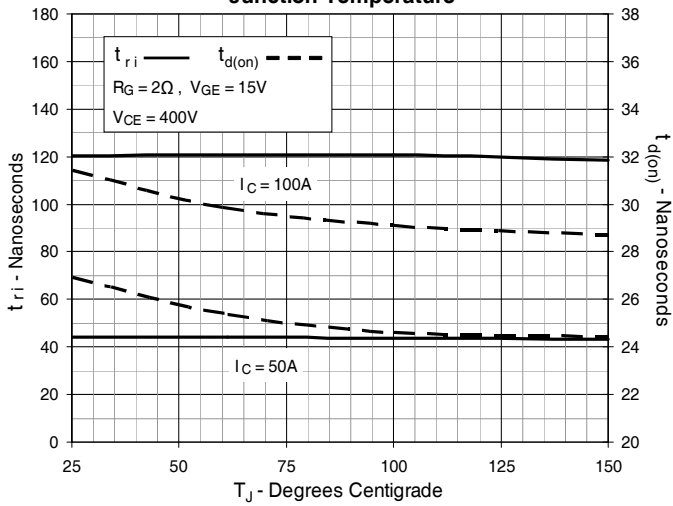

**Fig. 21. Diode Forward Characteristics**

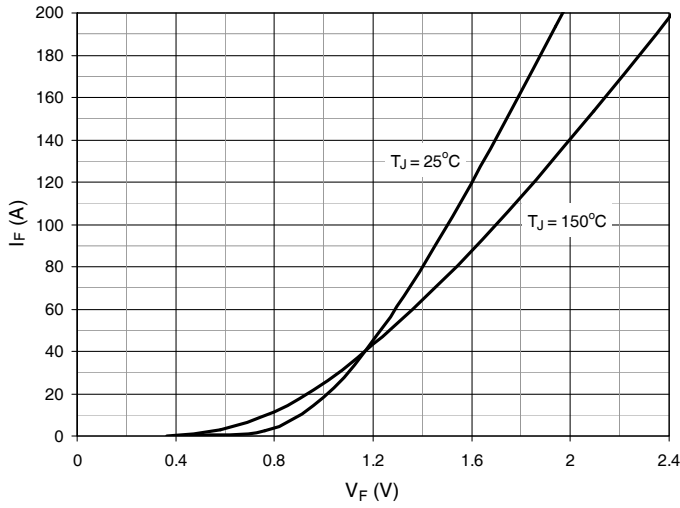

**Fig. 22. Reverse Recovery Charge vs.  $-di_F/dt$**

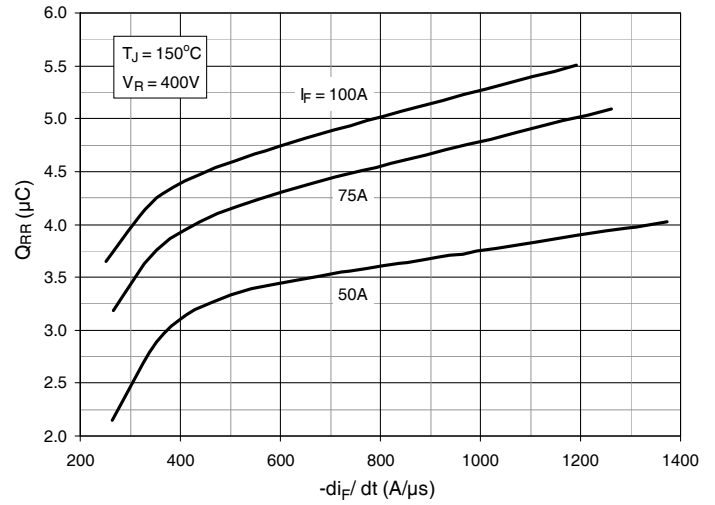

**Fig. 23. Reverse Recovery Current vs.  $-di_F/dt$**

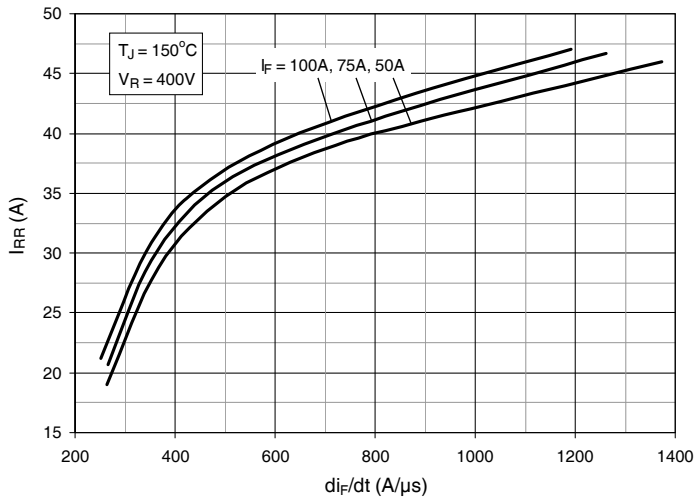

**Fig. 24. Reverse Recovery Time vs.  $-di_F/dt$**

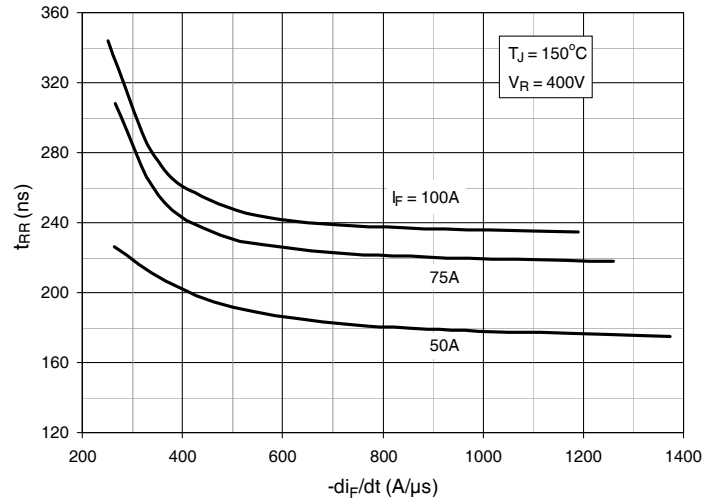

**Fig. 25. Dynamic Parameters  $Q_{RR}$ ,  $I_{RR}$  vs. Junction Temperature**

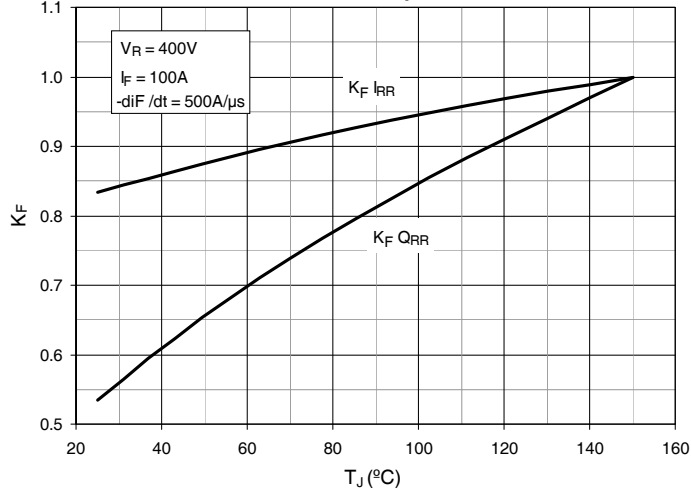

**Fig. 26. Maximum Transient Thermal Impedance (Diode)**

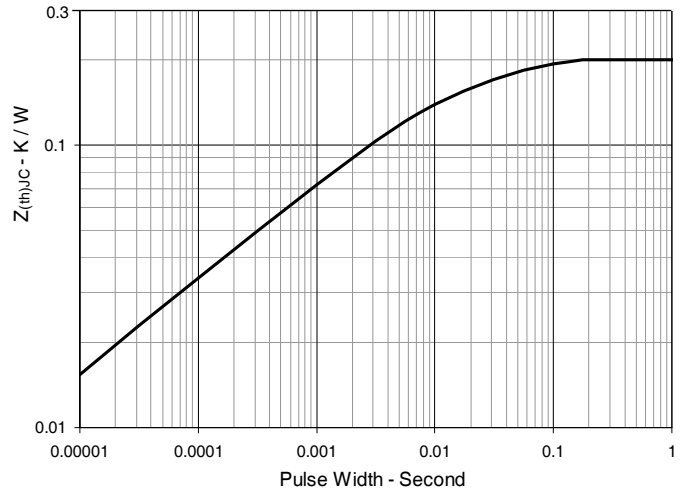



---

Disclaimer Notice - Information furnished is believed to be accurate and reliable. However, users should independently evaluate the suitability of and test each product selected for their own applications. Littelfuse products are not designed for, and may not be used in, all applications. Read complete Disclaimer Notice at [www.littelfuse.com/disclaimer-electronics](http://www.littelfuse.com/disclaimer-electronics).