

# XPT IGBT

preliminary

$$V_{CES} = 1200V$$

$$I_{C25} = 20A$$

$$V_{CE(sat)} = 1.8V$$

Copack

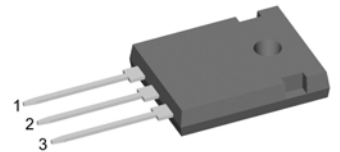
**Part number**
**IXA12IF1200HB**

Backside: collector

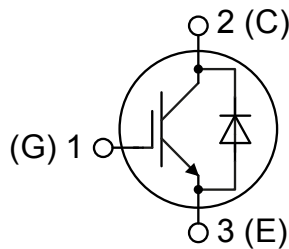
**Features / Advantages:**

- Easy paralleling due to the positive temperature coefficient of the on-state voltage
- Rugged XPT design (Xtreme light Punch Through) results in:
  - short circuit rated for 10  $\mu$ sec.
  - very low gate charge
  - low EMI
  - square RBSOA @ 3x Ic
- Thin wafer technology combined with the XPT design results in a competitive low VCE(sat)
- SONIC™ diode
  - fast and soft reverse recovery
  - low operating forward voltage

**Applications:**

- AC motor drives
- Solar inverter
- Medical equipment
- Uninterruptible power supply
- Air-conditioning systems
- Welding equipment
- Switched-mode and resonant-mode power supplies
- Inductive heating, cookers
- Pumps, Fans

**Package: TO-247**

- Industry standard outline
- RoHS compliant
- Epoxy meets UL 94V-0

IGBT				Ratings			
Symbol	Definition	Conditions	min.	typ.	max.	Unit	
$V_{CES}$	collector emitter voltage	$T_{VJ} = 25^{\circ}C$			1200	V	
$V_{GES}$	max. DC gate voltage				$\pm 20$	V	
$V_{GEM}$	max. transient gate emitter voltage				$\pm 30$	V	
$I_{C25}$	collector current	$T_C = 25^{\circ}C$			20	A	
$I_{C100}$		$T_C = 100^{\circ}C$			13	A	
$P_{tot}$	total power dissipation	$T_C = 25^{\circ}C$			85	W	
$V_{CE(sat)}$	collector emitter saturation voltage	$I_C = 10A; V_{GE} = 15V$		1.8	2.1	V	
				2.1		V	
$V_{GE(th)}$	gate emitter threshold voltage	$I_C = 0.3mA; V_{CE} = V_{CE}$	5.4	5.9	6.5	V	
$I_{CES}$	collector emitter leakage current	$V_{CE} = V_{CES}; V_{GE} = 0V$			0.1	mA	
				0.1		mA	
$I_{GES}$	gate emitter leakage current	$V_{GE} = \pm 20V$			500	nA	
$Q_{G(on)}$	total gate charge	$V_{CE} = 600V; V_{GE} = 15V; I_C = 10A$		27		nC	
$t_{d(on)}$	turn-on delay time	inductive load $V_{CE} = 600V; I_C = 10A$ $V_{GE} = \pm 15V; R_G = 100\Omega$		70		ns	
$t_r$	current rise time		$T_{VJ} = 125^{\circ}C$	40		ns	
$t_{d(off)}$	turn-off delay time		250		ns		
$t_f$	current fall time		100		ns		
$E_{on}$	turn-on energy per pulse		1.1		mJ		
$E_{off}$	turn-off energy per pulse		1.1		mJ		
<b>RBSOA</b>	reverse bias safe operating area	$V_{GE} = \pm 15V; R_G = 100\Omega$					
$I_{CM}$		$V_{CEmax} = 1200V$			30	A	
<b>SCSOA</b>	short circuit safe operating area	$V_{CEmax} = 900V$					
$t_{sc}$	short circuit duration	$V_{CE} = 900V; V_{GE} = \pm 15V$			10	$\mu s$	
$I_{sc}$	short circuit current	$R_G = 100\Omega; \text{non-repetitive}$		40		A	
$R_{thJC}$	thermal resistance junction to case				1.5	K/W	
$R_{thCH}$	thermal resistance case to heatsink			0.25		K/W	
<b>Diode</b>							
$V_{RRM}$	max. repetitive reverse voltage	$T_{VJ} = 25^{\circ}C$			1200	V	
$I_{F25}$	forward current	$T_C = 25^{\circ}C$			22	A	
$I_{F100}$		$T_C = 100^{\circ}C$			14	A	
$V_F$	forward voltage	$I_F = 10A$			2.20	V	
				1.95		V	
$I_R$	reverse current	$V_R = V_{RRM}$			*	mA	
	* not applicable, see Ices value above				*	mA	
$Q_{rr}$	reverse recovery charge	$V_R = 600V$ $-di_F/dt = -250A/\mu s$ $I_F = 10A; V_{GE} = 0V$		1.3		$\mu C$	
$I_{RM}$	max. reverse recovery current		$T_{VJ} = 125^{\circ}C$	10.5		A	
$t_{rr}$	reverse recovery time		350		ns		
$E_{rec}$	reverse recovery energy		0.35		mJ		
$R_{thJC}$	thermal resistance junction to case				1.8	K/W	
$R_{thCH}$	thermal resistance case to heatsink			0.25		K/W	

preliminary

Package TO-247			Ratings			
Symbol	Definition	Conditions	min.	typ.	max.	Unit
$I_{RMS}$	RMS current	per terminal			70	A
$T_{VJ}$	virtual junction temperature		-40		150	°C
$T_{op}$	operation temperature		-40		125	°C
$T_{stg}$	storage temperature		-40		150	°C
<b>Weight</b>				6		g
$M_D$	mounting torque		0.8		1.2	Nm
$F_C$	mounting force with clip		20		120	N

### Product Marking

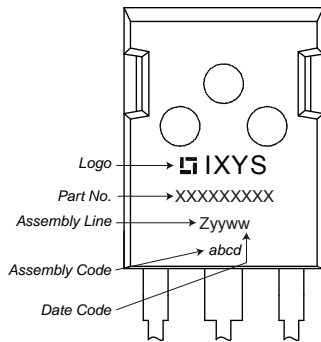

### Part number

- I = IGBT
- X = XPT IGBT
- A = Gen 1 / std
- 12 = Current Rating [A]
- IF = Copack
- 1200 = Reverse Voltage [V]
- HB = TO-247AD (3)

Ordering	Part Number	Marking on Product	Delivery Mode	Quantity	Code No.
Standard	IXA12IF1200HB	IXA12IF1200HB	Tube	30	508453

Similar Part	Package	Voltage class
IXA12IF1200PB	TO-220AB (3)	1200
IXA12IF1200TC	TO-268AA (D3Pak) (2)	1200

### Equivalent Circuits for Simulation

\* on die level

$T_{VJ} = 150\text{ °C}$

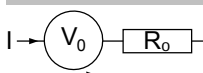

$V_{0\ max}$  threshold voltage

$R_{0\ max}$  slope resistance \*

	IGBT	Diode	
$V_{0\ max}$	1.1	1.25	V
$R_{0\ max}$	153	85	mΩ

## Outlines TO-247

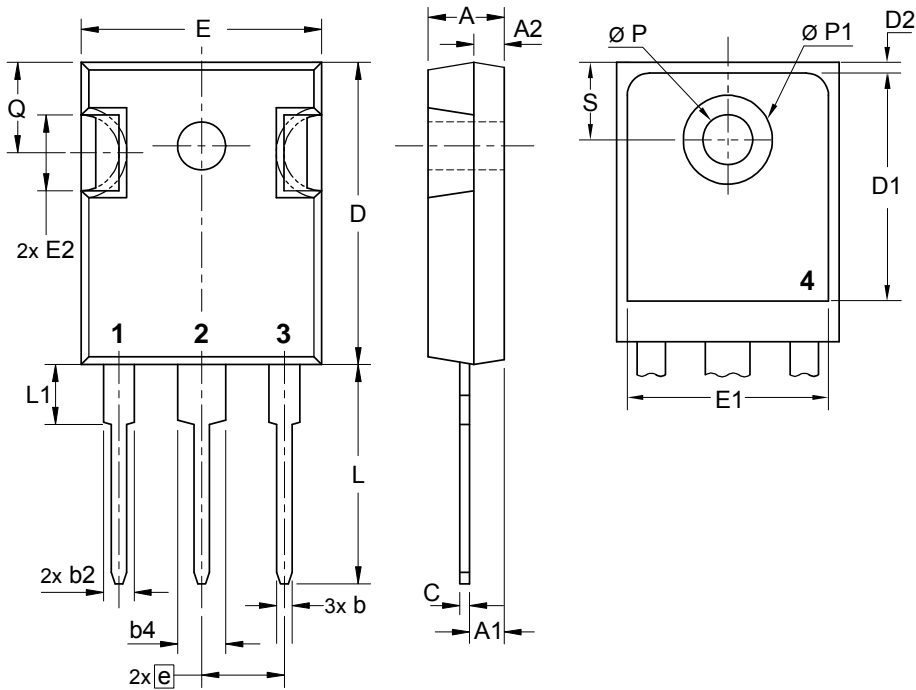

Sym.	Inches		Millimeter	
	min.	max.	min.	max.
A	0.185	0.209	4.70	5.30
A1	0.087	0.102	2.21	2.59
A2	0.059	0.098	1.50	2.49
D	0.819	0.845	20.79	21.45
E	0.610	0.640	15.48	16.24
E2	0.170	0.216	4.31	5.48
e	0.215 BSC		5.46 BSC	
L	0.780	0.800	19.80	20.30
L1	-	0.177	-	4.49
Ø P	0.140	0.144	3.55	3.65
Q	0.212	0.244	5.38	6.19
S	0.242 BSC		6.14 BSC	
b	0.039	0.055	0.99	1.40
b2	0.065	0.094	1.65	2.39
b4	0.102	0.135	2.59	3.43
c	0.015	0.035	0.38	0.89
D1	0.515	-	13.07	-
D2	0.020	0.053	0.51	1.35
E1	0.530	-	13.45	-
Ø P1	-	0.29	-	7.39

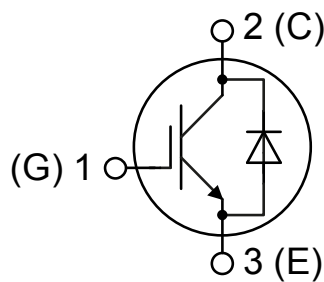

## IGBT

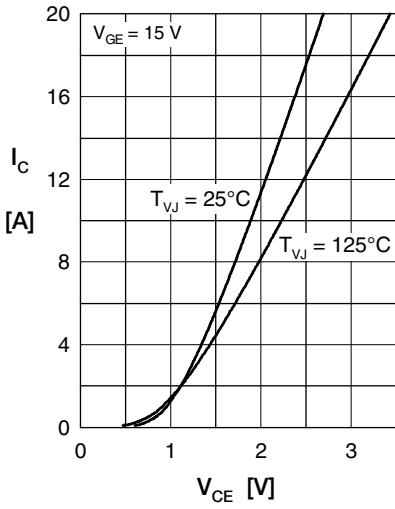

Fig. 1 Typ. output characteristics

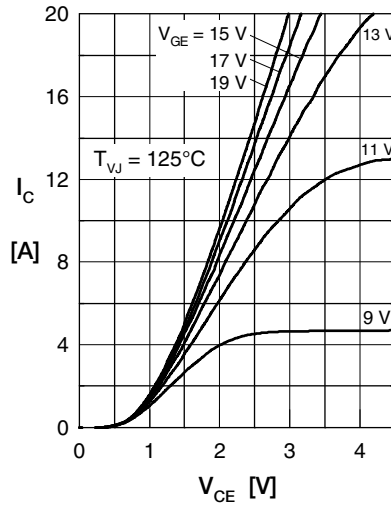

Fig. 2 Typ. output characteristics

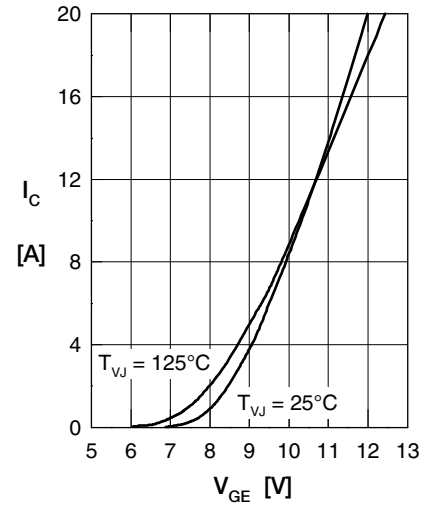

Fig. 3 Typ. transfer characteristics

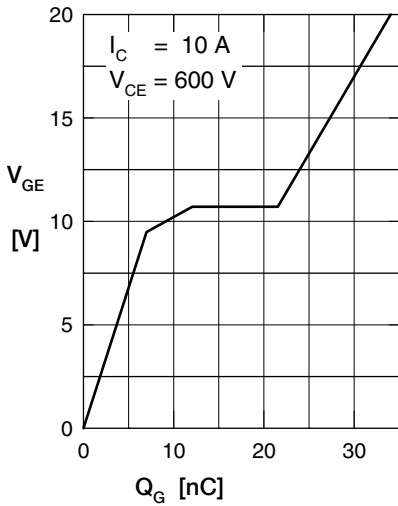

Fig. 4 Typ. turn-on gate charge

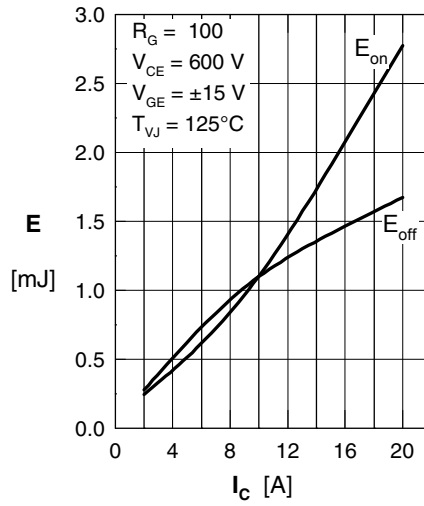

Fig. 5 Typ. switching energy vs. collector current

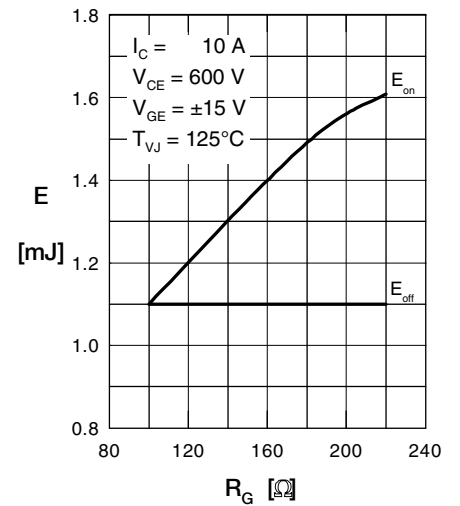

Fig. 6 Typ. switching energy vs. gate resistance

Fig. 7 Typ. transient thermal impedance junction to case

## Diode

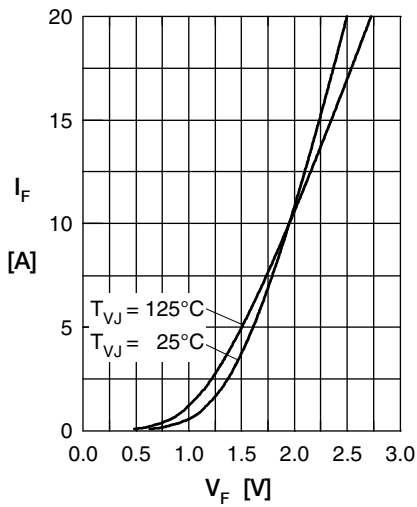

Fig. 1 Typ. forward current versus  $V_F$

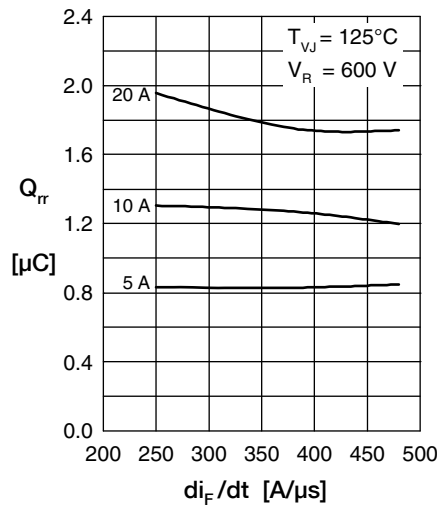

Fig. 2 Typical reverse recov. charge  $Q_{rr}$  versus  $di_F/dt$

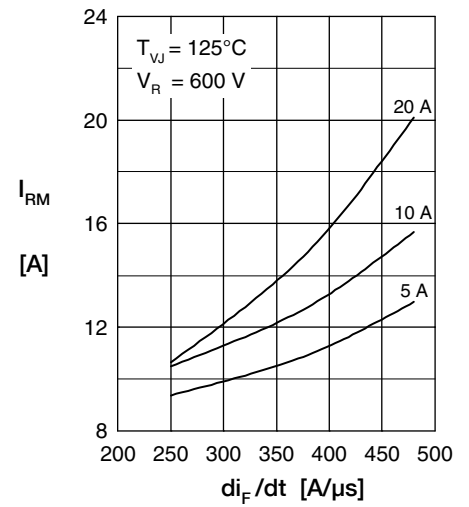

Fig. 3 Typ: peak reverse current  $I_{RM}$  versus  $di_F/dt$

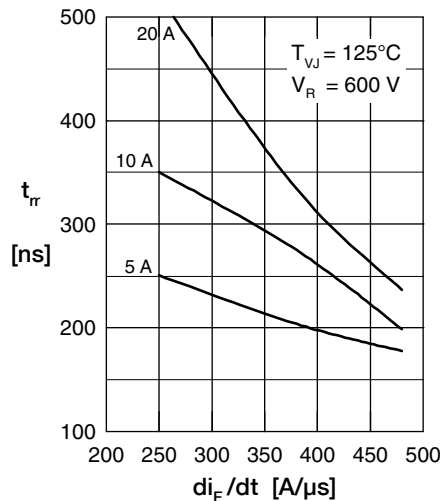

Fig. 4 Dynamic parameters  $Q_{rr}$ ,  $I_{RM}$  versus  $T_{VJ}$

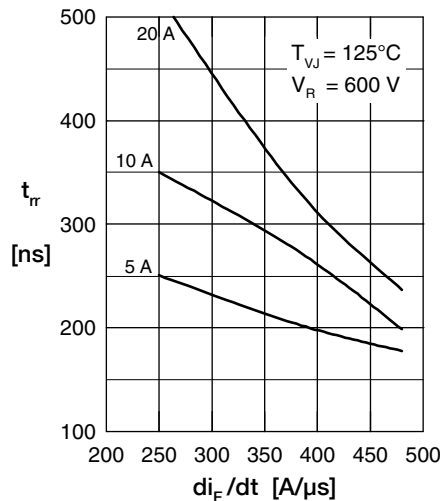

Fig. 5 Typ. recovery time  $t_{rr}$  versus  $di_F/dt$

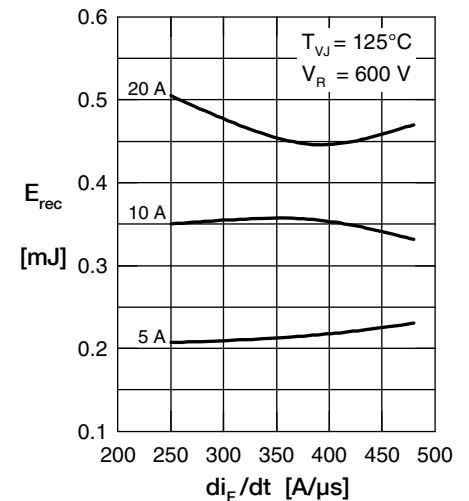

Fig. 6 Typ. recovery energy  $E_{rec}$  vs.  $di_F/dt$

Fig. 7 Typ. transient thermal impedance junction to case



---

Disclaimer Notice - Information furnished is believed to be accurate and reliable. However, users should independently evaluate the suitability of and test each product selected for their own applications. Littelfuse products are not designed for, and may not be used in, all applications. Read complete Disclaimer Notice at [www.littelfuse.com/disclaimer-electronics](http://www.littelfuse.com/disclaimer-electronics).