

High Voltage XPT™ IGBT w/ Diode

IXYX25N250CV1 IXYX25N250CV1HV

$V_{CES} = 2500V$
 $I_{C110} = 25A$
 $V_{CE(sat)} \leq 4.0V$
 $t_{fi(typ)} = 246ns$

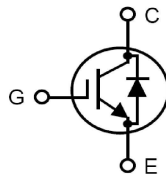

Symbol	Test Conditions	Maximum Ratings	
V_{CES}	$T_J = 25^\circ C$ to $175^\circ C$	2500	V
V_{CGR}	$T_J = 25^\circ C$ to $175^\circ C$, $R_{GE} = 1M\Omega$	2500	V
V_{GES}	Continuous	± 20	V
V_{GEM}	Transient	± 30	V
I_{C25}	$T_C = 25^\circ C$	95	A
I_{C110}	$T_C = 110^\circ C$	25	A
I_{F110}	$T_C = 110^\circ C$	30	A
I_{CM}	$T_C = 25^\circ C$, 1ms	235	A
SSOA (RBSOA)	$V_{GE} = 15V$, $T_{VJ} = 150^\circ C$, $R_G = 5\Omega$ Clamped Inductive Load	$I_{CM} = 100$	A
		1500	V
P_C	$T_C = 25^\circ C$	937	W
T_J		-55 ... +175	$^\circ C$
T_{JM}		175	$^\circ C$
T_{stg}		-55 ... +175	$^\circ C$
T_L	Maximum Lead Temperature for Soldering 1.6 mm (0.062in.) from Case for 10s	300	$^\circ C$
F_C	Mounting Force	20..120 / 4.5..27	N/lb
Weight		6	g

PLUS247
(IXYX)

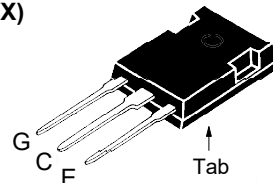

TO-247PLUS-HV
(IXYX..HV)

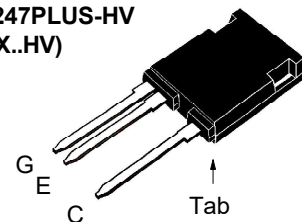

G = Gate E = Emitter
 C = Collector Tab = Collector

Features

- High Voltage Packages
- High Blocking Voltage
- High Peak Current Capability
- Low Saturation Voltage

Advantages

- Low Gate Drive Requirement
- High Power Density

Applications

- Switch-Mode and Resonant-Mode Power Supplies
- Uninterruptible Power Supplies (UPS)
- Laser Generators
- Capacitor Discharge Circuits
- AC Switches

Symbol	Test Conditions ($T_J = 25^\circ C$, Unless Otherwise Specified)	Characteristic Values		
		Min.	Typ.	Max.
BV_{CES}	$I_C = 250\mu A$, $V_{GE} = 0V$	2500		V
$V_{GE(th)}$	$I_C = 250\mu A$, $V_{CE} = V_{GE}$	3.0		V
I_{CES}	$V_{CE} = V_{CES}$, $V_{GE} = 0V$ $T_J = 100^\circ C$			25 μA
			100	μA
I_{GES}	$V_{CE} = 0V$, $V_{GE} = \pm 20V$			± 100 nA
$V_{CE(sat)}$	$I_C = 25A$, $V_{GE} = 15V$, Note 1 $T_J = 150^\circ C$		3.4	V
			4.7	V

Symbol Test Conditions ($T_J = 25^\circ\text{C}$ Unless Otherwise Specified)		Characteristic Values		
		Min.	Typ.	Max.
g_{fs}	$I_C = 25\text{A}, V_{CE} = 10\text{V}$, Note 1	16	27	S
R_{Gi}	Gate Input Resistance		2.8	Ω
C_{ies}	$V_{CE} = 25\text{V}, V_{GE} = 0\text{V}, f = 1\text{MHz}$		3060	pF
C_{oes}			166	pF
C_{res}			43	pF
$Q_{g(on)}$	$I_C = 25\text{A}, V_{GE} = 15\text{V}, V_{CE} = 0.5 \cdot V_{CES}$		147	nC
Q_{ge}			16	nC
Q_{gc}			68	nC
$t_{d(on)}$	Inductive load, $T_J = 25^\circ\text{C}$ $I_C = 25\text{A}, V_{GE} = 15\text{V}$ $V_{CE} = 0.5 \cdot V_{CES}, R_G = 5\Omega$ Note 2		15	ns
t_{ri}			34	ns
E_{on}			8.3	mJ
$t_{d(off)}$			230	ns
t_{fi}			246	ns
E_{off}			7.3	mJ
$t_{d(on)}$	Inductive load, $T_J = 150^\circ\text{C}$ $I_C = 25\text{A}, V_{GE} = 15\text{V}$ $V_{CE} = 0.5 \cdot V_{CES}, R_G = 5\Omega$ Note 2		18	ns
t_{ri}			33	ns
E_{on}			11.0	mJ
$t_{d(off)}$			225	ns
t_{fi}			350	ns
E_{off}			10.5	mJ
R_{thJC}			0.16	$^\circ\text{C/W}$
R_{thCS}		0.15		$^\circ\text{C/W}$

Reverse Sonic Diode (FRD)

Symbol Test Conditions ($T_J = 25^\circ\text{C}$ Unless Otherwise Specified)		Characteristic Values		
		Min.	Typ.	Max.
V_F	$I_F = 25\text{A}, V_{GE} = 0\text{V}$, Note 1 $T_J = 150^\circ\text{C}$		3.1	3.5 V V
I_{RM}	$I_F = 25\text{A}, V_{GE} = 0\text{V}, T_J = 150^\circ\text{C}$ $-di_F/dt = 500\text{A}/\mu\text{s}, V_R = 1200\text{V}$		38	A
t_{rr}			185	ns
R_{thJC}			0.32	$^\circ\text{C/W}$

Notes:

1. Pulse test, $t \leq 300\mu\text{s}$, duty cycle, $d \leq 2\%$.
2. Switching times & energy losses may increase for higher V_{CE} (Clamp), T_J or R_G .

Littelfuse reserves the right to change limits, test conditions, and dimensions.

LF MOSFETs and IGBTs are covered by one or more of the following U.S. patents:	4,835,592	4,931,844	5,049,961	5,237,481	6,162,665	6,404,065 B1	6,683,344	6,727,585	7,005,734 B2	7,157,338 B2
	4,860,072	5,017,508	5,063,307	5,381,025	6,259,123 B1	6,534,343	6,710,405 B2	6,759,692	7,063,975 B2	
	4,881,106	5,034,796	5,187,117	5,486,715	6,306,728 B1	6,583,505	6,710,463	6,771,478 B2	7,071,537	

Fig. 1. Output Characteristics @ $T_J = 25^\circ\text{C}$

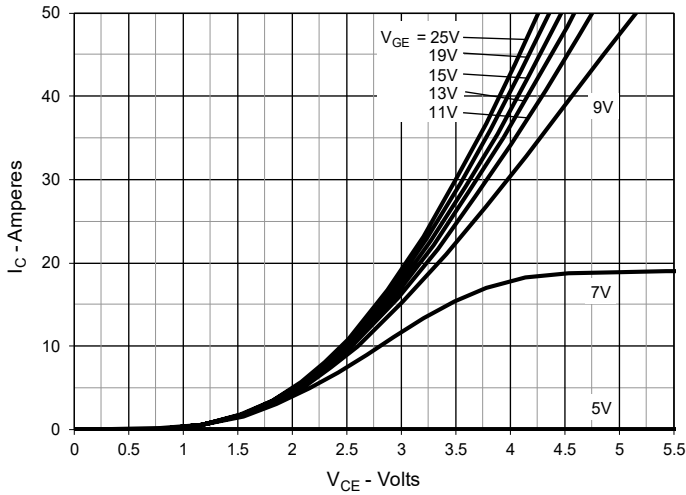

Fig. 2. Extended Output Characteristics @ $T_J = 25^\circ\text{C}$

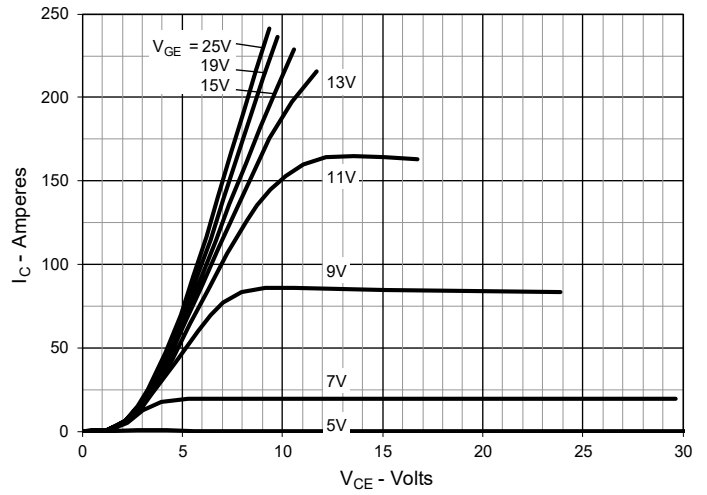

Fig. 3. Output Characteristics @ $T_J = 150^\circ\text{C}$

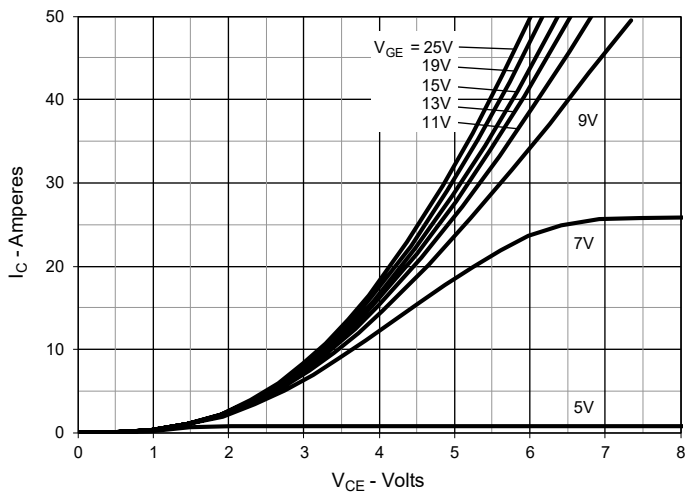

Fig. 4. Dependence of $V_{CE(sat)}$ on Junction Temperature

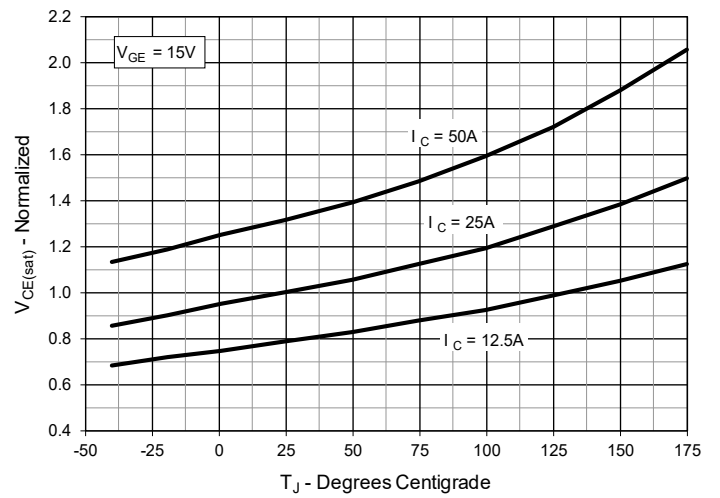

Fig. 5. Collector-to-Emitter Voltage vs. Gate-to-Emitter Voltage

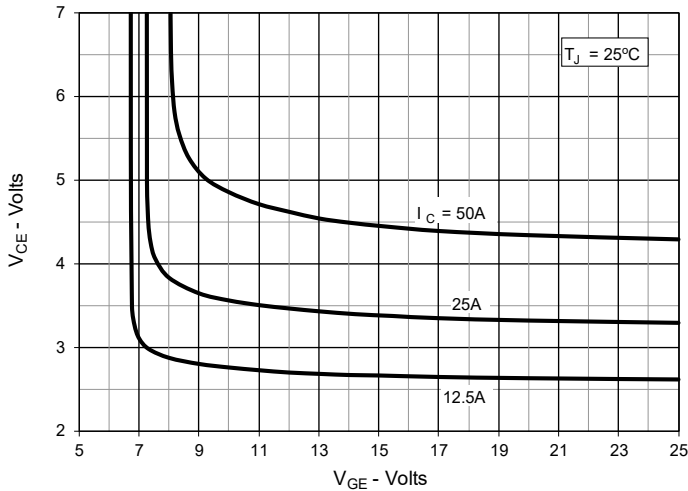

Fig. 6. Input Admittance

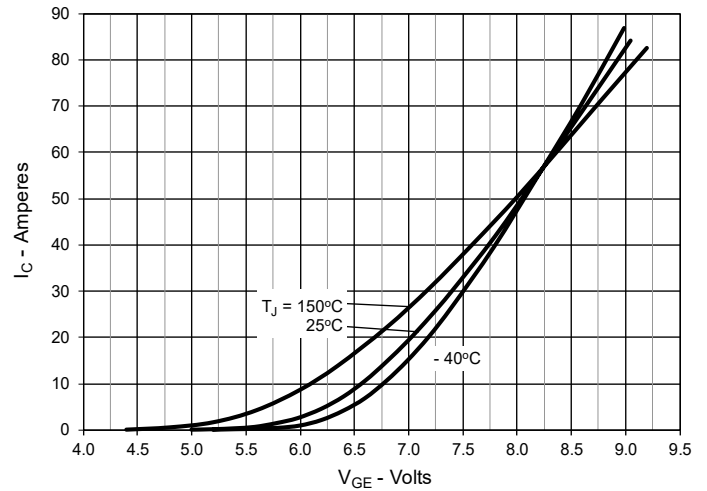

Fig. 7. Transconductance

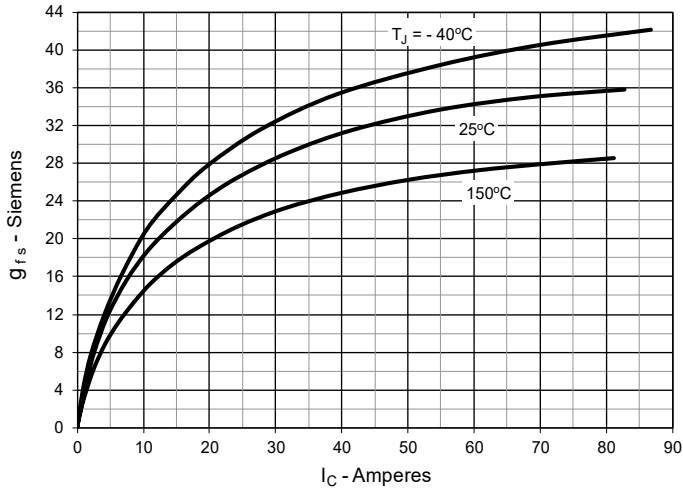

Fig. 8. Gate Charge

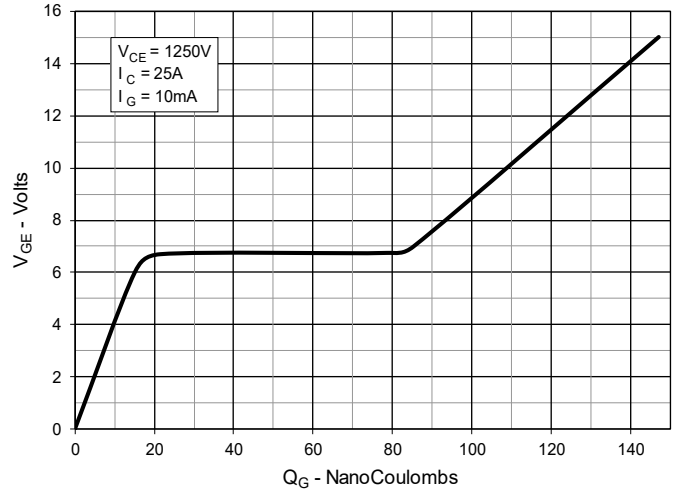

Fig. 9. Capacitance

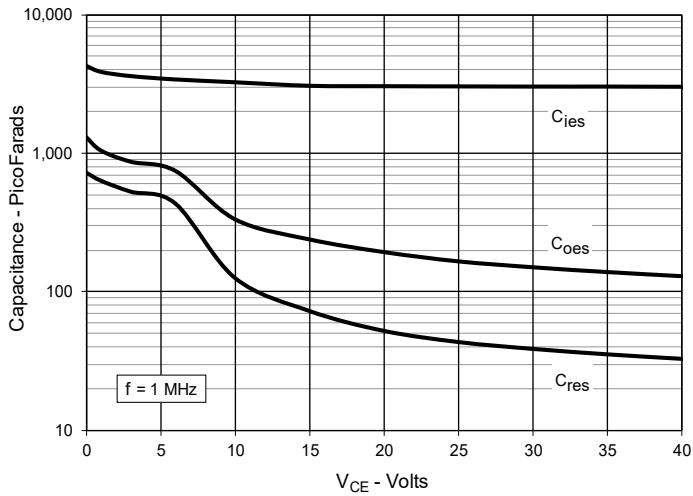

Fig. 10. Reverse-Bias Safe Operating Area

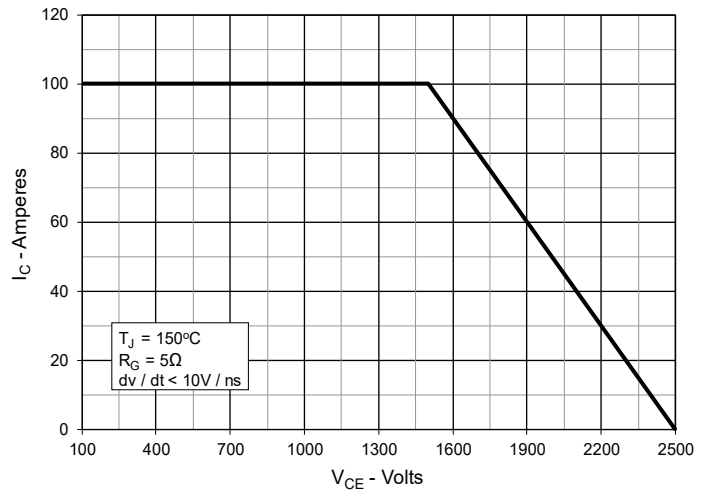

Fig. 11. Forward-Bias Safe Operating Area

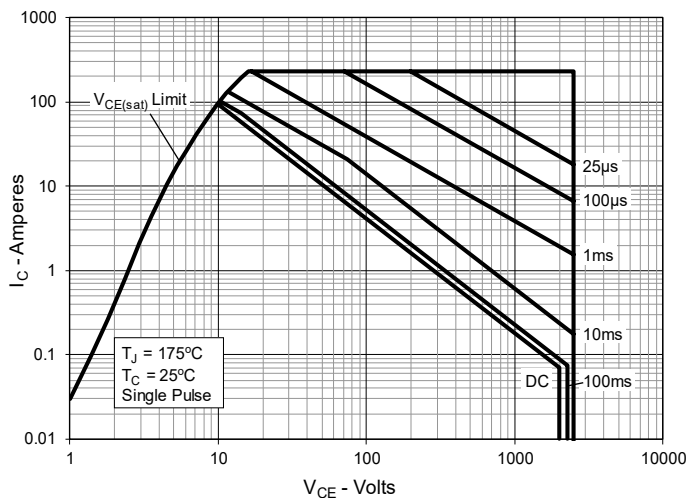

Fig. 12. Maximum Transient Thermal Impedance

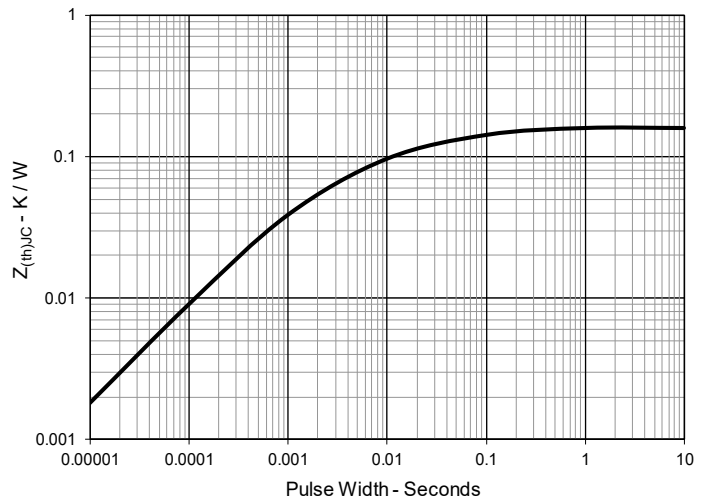

Fig. 13. Inductive Switching Energy Loss vs. Gate Resistance

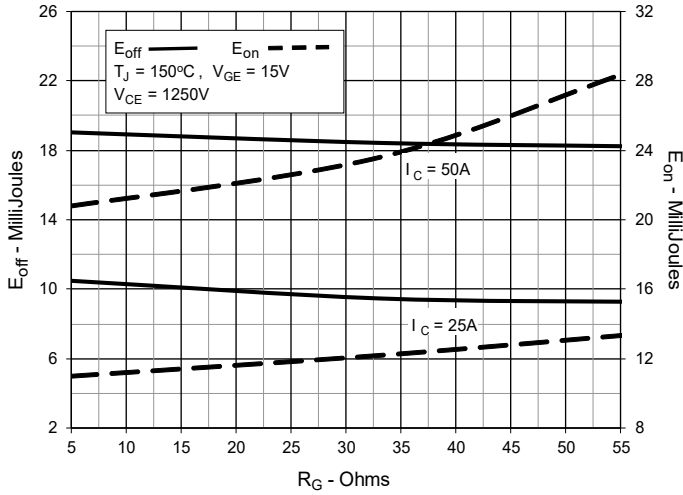

Fig. 14. Inductive Switching Energy Loss vs. Collector Current

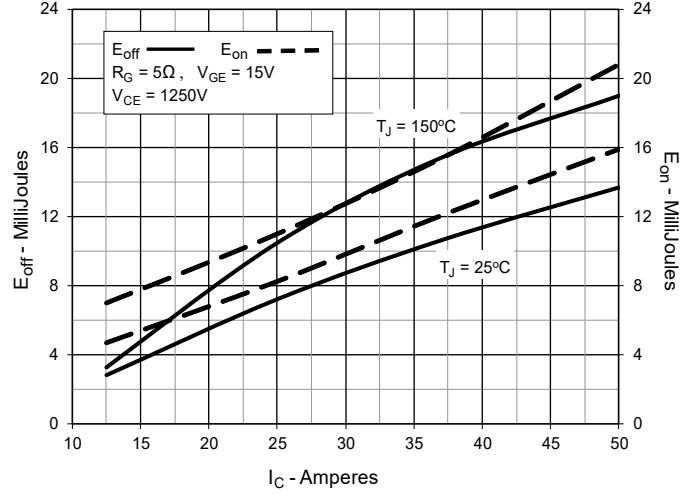

Fig. 15. Inductive Switching Energy Loss vs. Junction Temperature

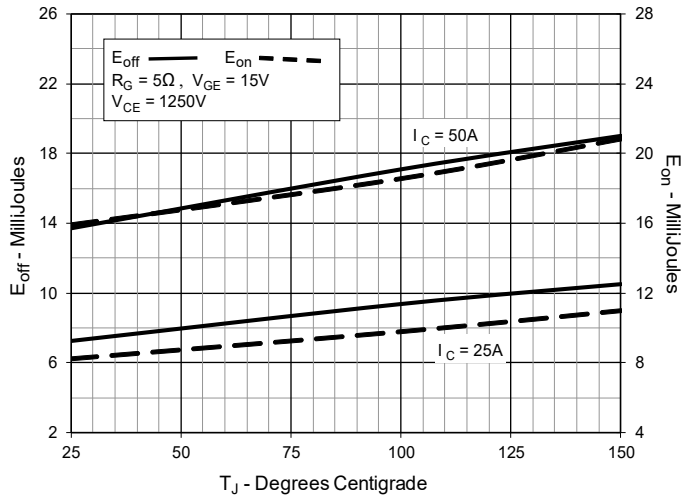

Fig. 16. Inductive Turn-off Switching Times vs. Gate Resistance

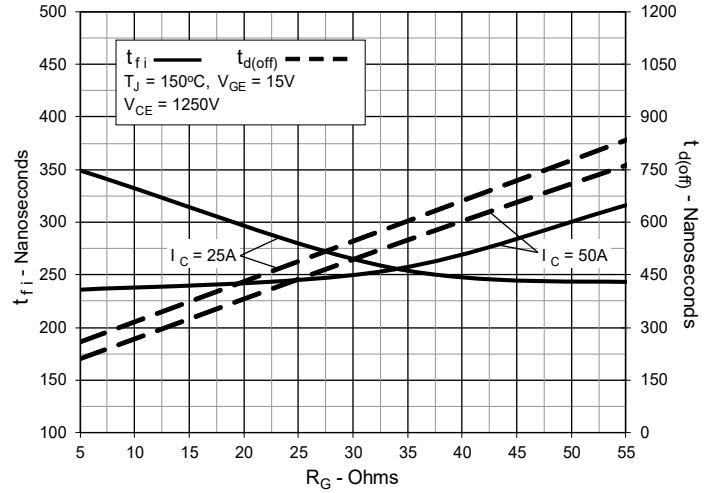

Fig. 17. Inductive Turn-off Switching Times vs. Collector Current

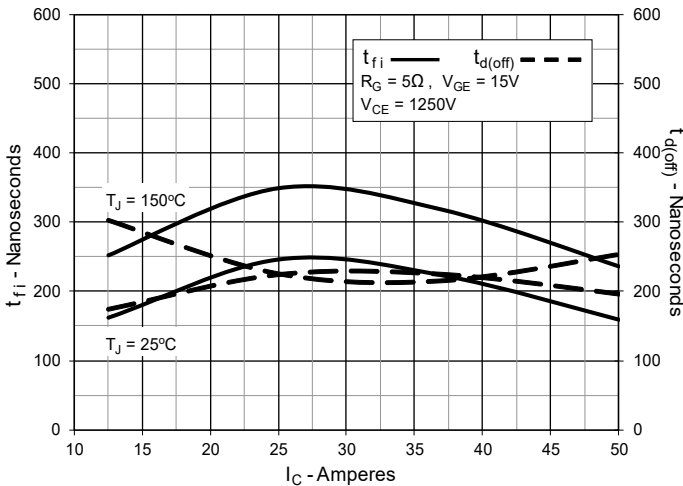

Fig. 18. Inductive Turn-off Switching Times vs. Junction Temperature

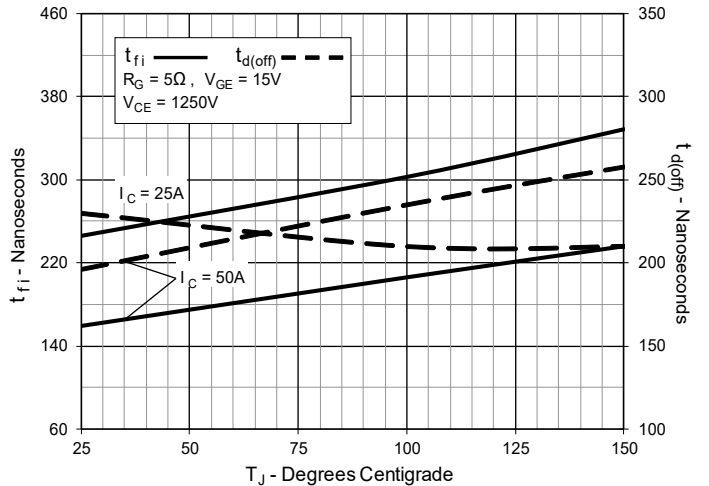

Fig. 19. Inductive Turn-on Switching Times vs. Gate Resistance

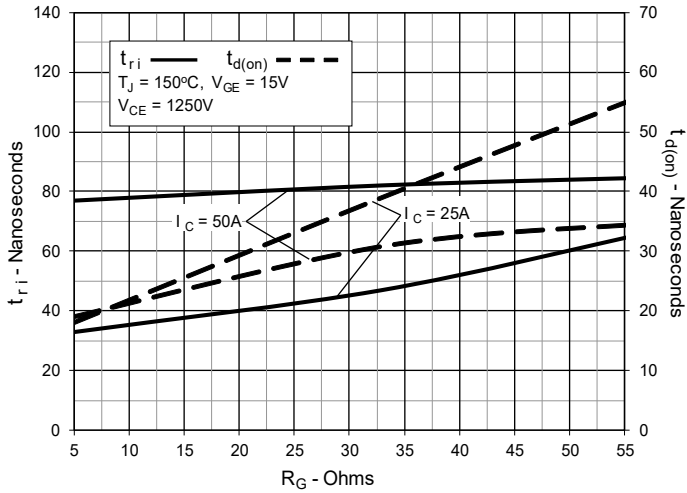

Fig. 20. Inductive Turn-on Switching Times vs. Collector Current

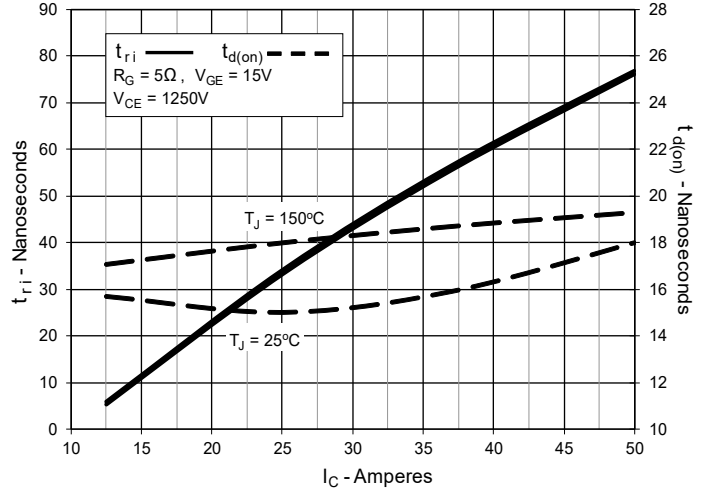

Fig. 21. Inductive Turn-on Switching Times vs. Junction Temperature

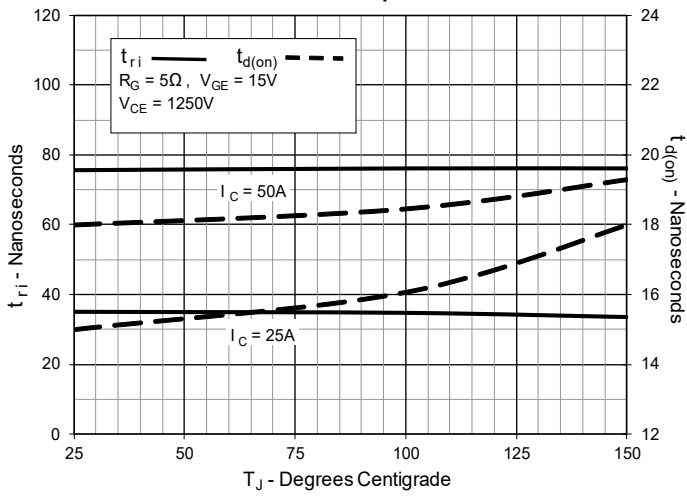

Fig. 22. Diode Forward Characteristics

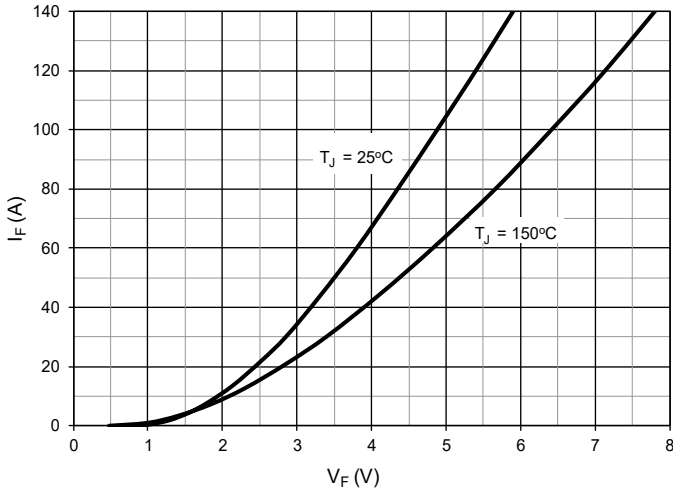

Fig. 23. Reverse Recovery Charge vs. $-di_F/dt$

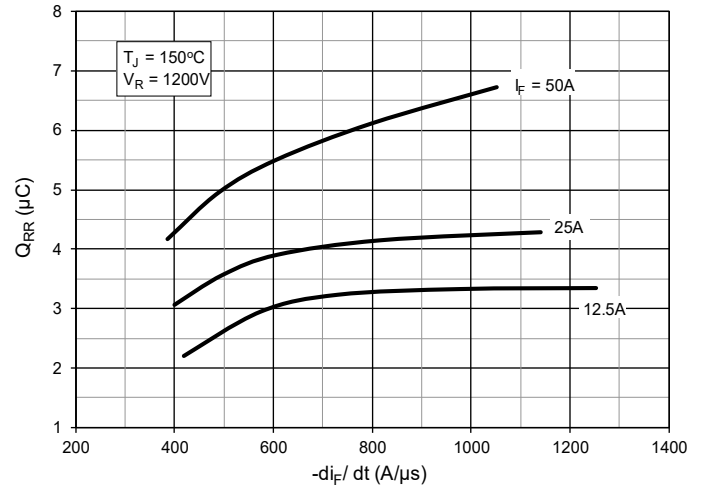

Fig. 24. Reverse Recovery Current vs. $-di_F/dt$

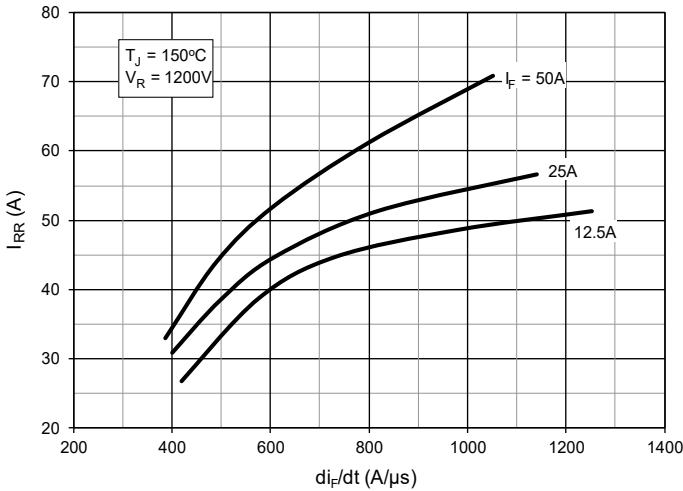

Fig. 25. Reverse Recovery Time vs. $-di_F/dt$

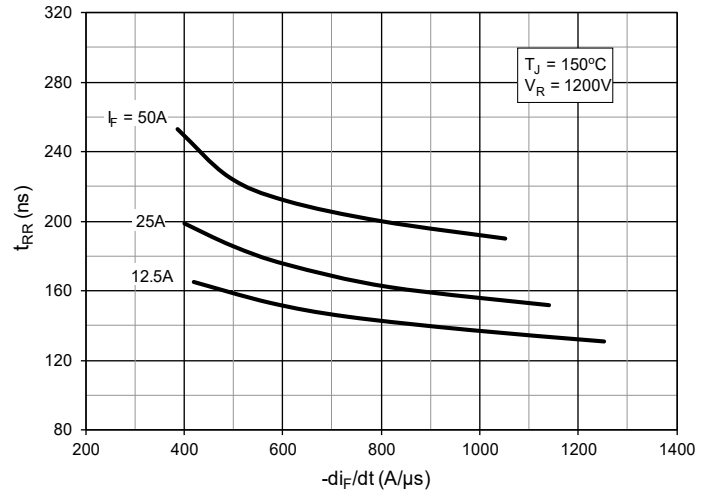

Fig. 26. Dynamic Parameters Q_{RR} , I_{RR} vs. Junction Temperature

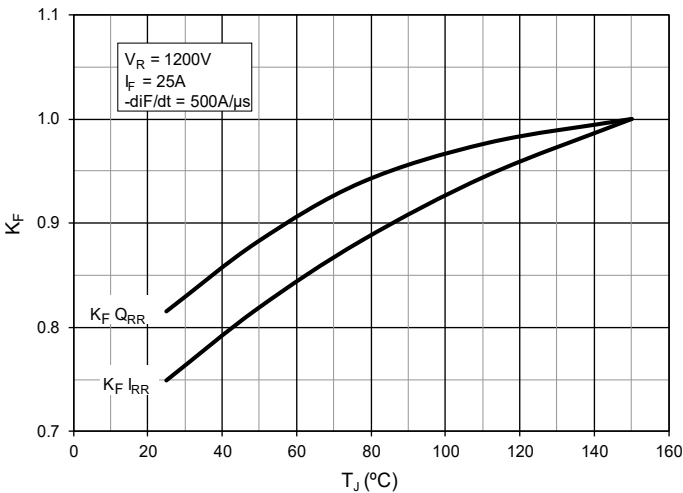
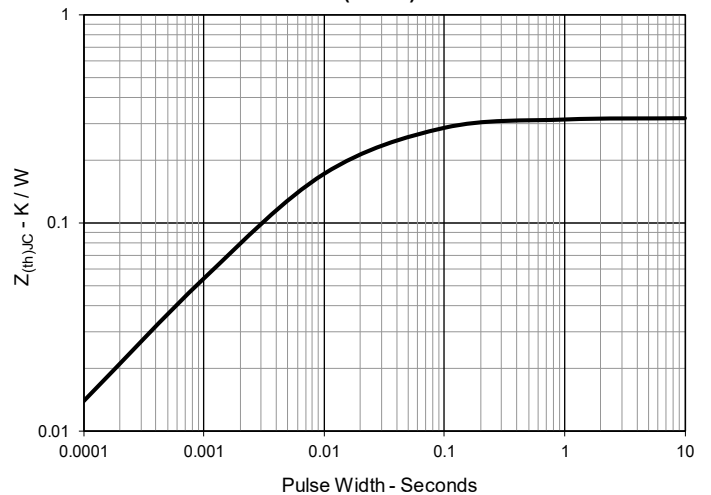
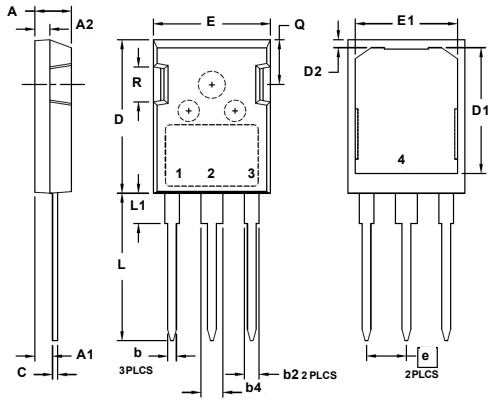

Fig. 27. Maximum Transient Thermal Impedance (Diode)



PLUS247™ Outline

1 - Gate 3 - Emitter
 2,4 - Collector

SYM	Inches		Millimeters	
	MIN	MAX	MIN	MAX
A	0.193	0.205	4.83	5.21
A1	0.090	0.100	2.29	2.54
A2	0.075	0.085	1.91	2.16
b	0.045	0.055	1.14	1.40
b2	0.075	0.087	1.91	2.20
b4	0.115	0.126	2.92	3.20
C	0.024	0.031	0.61	0.80
D	0.819	0.840	20.80	21.34
D1	0.650	0.690	16.51	17.53
D2	0.035	0.050	0.89	1.27
E	0.620	0.635	15.75	16.13
E1	0.520	0.560	13.08	14.22
e	0.215	BSC	5.45	BSC
L	0.780	0.810	19.81	20.57
L1	0.150	0.170	3.81	4.32
Q	0.220	0.244	5.59	6.20
R	0.170	0.190	4.32	4.83

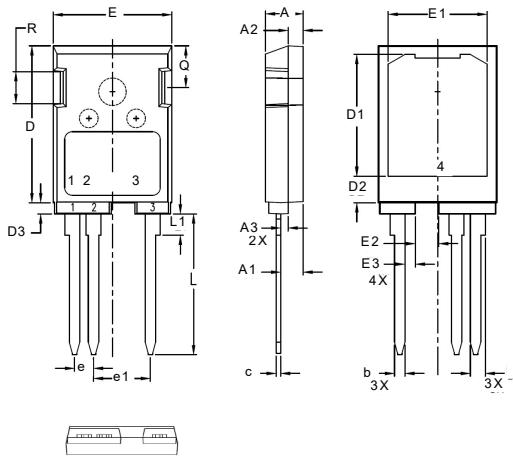
TO-247PLUS-HV Outline

1 - Gate
 2,4 - Emitter
 3 - Collector

SYM	Inches		Millimeters	
	MIN	MAX	MIN	MAX
A	0.193	0.201	4.90	5.10
A1	0.114	0.122	2.90	3.10
A2	0.075	0.083	1.90	2.10
A3	0.035	0.043	0.90	1.10
b	0.053	0.059	1.35	1.50
b1	0.075	0.083	1.90	2.10
c	0.022	0.030	0.55	0.75
D	0.819	0.843	20.8	21.4
D1	0.638	0.646	16.2	16.4
D2	0.134	0.146	3.40	3.70
D3	0.055	0.063	1.40	1.60
E	0.622	0.638	15.8	16.2
E1	0.520	0.528	13.2	13.4
E2	0.118	0.126	3.00	3.20
E3	0.051	0.059	1.30	1.50
e	0.100	BSC	2.54	BSC
e1	0.300	BSC	7.62	BSC
L	0.732	0.748	18.60	19.0
L1	0.106	0.118	2.70	3.00
Q	0.216	0.224	5.50	5.70
R	0.165	0.169	4.20	4.30



Disclaimer Notice - Information furnished is believed to be accurate and reliable. However, users should independently evaluate the suitability of and test each product selected for their own applications. Littelfuse products are not designed for, and may not be used in, all applications. Read complete Disclaimer Notice at www.littelfuse.com/disclaimer-electronics.
