

# XPT IGBT

tentative

$$V_{CES} = 1200V$$

$$I_{C25} = 32A$$

$$V_{CE(sat)} = 1.8V$$

ISOPLUS™ Surface Mount Power Device  
 Boost Topology  
 XPT IGBT

Part number

**IXA20RG1200DHGLB**



Backside: isolated

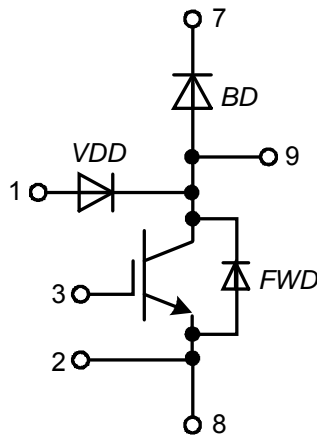
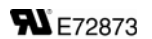

### Features / Advantages:

- XPT IGBT
  - low saturation voltage
  - positive temperature coefficient for easy paralleling
  - fast switching
  - short tail current for optimized performance in resonant circuits
- Sonic™ diode
  - fast reverse recovery
  - low operating forward voltage
  - low leakage current
  - low temperature dependency of reverse recovery
- Vcesat detection diode (VDD)
  - integrated into package
  - very fast diode

### Applications:

- AC drives
  - brake chopper
- PFC
  - boost chopper
- Switched reluctance drives

### Package: SMPD

- Industry convenient outline
- RoHS compliant
- Epoxy meets UL 94V-0
- Soldering pins for PCB mounting
- Backside: DCB ceramic
- Reduced weight
- Advanced power cycling
- Isolation Voltage: 3000 V~

Free Wheeling Diode FWD				Ratings			
Symbol	Definition	Conditions	min.	typ.	max.	Unit	
$V_{RSM}$	max. non-repetitive reverse blocking voltage	$T_{VJ} = 25^{\circ}C$			1200	V	
$V_{RRM}$	max. repetitive reverse blocking voltage	$T_{VJ} = 25^{\circ}C$			1200	V	
$I_R$	reverse current, drain current	$V_R = 1200 V$	$T_{VJ} = 25^{\circ}C$		25	$\mu A$	
		$V_R = 1200 V$	$T_{VJ} = 125^{\circ}C$		0.4	mA	
$V_F$	forward voltage drop	$I_F = 20 A$	$T_{VJ} = 25^{\circ}C$		2.20	V	
						V	
		$I_F = 40 A$	$T_{VJ} = 125^{\circ}C$		2.20	V	
						V	
$I_{FAV}$	average forward current	$T_C = 80^{\circ}C$ rectangular $d = 0.5$	$T_{VJ} = 150^{\circ}C$		18	A	
$V_{FO}$	threshold voltage	} for power loss calculation only	$T_{VJ} = 150^{\circ}C$		1.29	V	
$r_F$	slope resistance				41	m $\Omega$	
$R_{thJC}$	thermal resistance junction to case				1.35	K/W	
$R_{thCH}$	thermal resistance case to heatsink			0.40		K/W	
$P_{tot}$	total power dissipation		$T_C = 25^{\circ}C$		93	W	
$I_{FSM}$	max. forward surge current	$t = 10 ms; (50 Hz), sine; V_R = 0 V$	$T_{VJ} = 45^{\circ}C$		150	A	
$C_J$	junction capacitance	$V_R = 400 V f = 1 MHz$	$T_{VJ} = 25^{\circ}C$		10	pF	

VCEsat Detection Diode VDD				Ratings			
Symbol	Definition	Conditions	min.	typ.	max.	Unit	
$V_{RRM}$	max. repetitive reverse blocking voltage	$T_{VJ} = 25^{\circ}C$			1200	V	
$I_R$	reverse current, drain current	$V_{R/D} = 1200 V$	$T_{VJ} = 25^{\circ}C$		2	$\mu A$	
		$V_{R/D} = 1200 V$	$T_{VJ} = 125^{\circ}C$		0.03	mA	
$V_F$	forward voltage drop	$I_F = 1 A$	$T_{VJ} = 25^{\circ}C$		2.20	V	
			$T_{VJ} = 125^{\circ}C$		1.80	V	
$V_{FO}$	threshold voltage	} for power loss calculation only	$T_{VJ} = 150^{\circ}C$		1.30	V	
$r_F$	slope resistance				390	m $\Omega$	
$C_J$	junction capacitance	$V_R = 400 V; f = 1 MHz$	$T_{VJ} = 25^{\circ}C$		tbd	pF	
$I_{RM}$	max. reverse recovery current	} $V_R = 100 V; I_F = 1 A$ $-di/dt = 100 A/\mu s$	$T_{VJ} = 25^{\circ}C$		2.3	A	
$t_{rr}$	reverse recovery time		$T_{VJ} = 125^{\circ}C$		tbd	A	
			$T_{VJ} = 25^{\circ}C$		40	ns	
			$T_{VJ} = 125^{\circ}C$		tbd	ns	

Boost IGBT				Ratings			
Symbol	Definition	Conditions	min.	typ.	max.	Unit	
$V_{CES}$	collector emitter voltage	$T_{VJ} = 25^{\circ}\text{C}$			1200	V	
$V_{GES}$	max. DC gate voltage				$\pm 20$	V	
$V_{GEM}$	max. transient collector gate voltage				$\pm 30$	V	
$I_{C25}$	collector current	$T_C = 25^{\circ}\text{C}$			32	A	
$I_{C80}$		$T_C = 80^{\circ}\text{C}$			23	A	
$P_{tot}$	total power dissipation	$T_C = 25^{\circ}\text{C}$			125	W	
$V_{CE(sat)}$	collector emitter saturation voltage	$I_C = 15\text{ A}; V_{GE} = 15\text{ V}$			1.8	V	
					2	V	
$V_{GE(th)}$	gate emitter threshold voltage	$I_C = 0.6\text{ mA}; V_{CE} = V_{CE}$	5.4	5.9	6.5	V	
$I_{CES}$	collector emitter leakage current	$V_{CE} = V_{CES}; V_{GE} = 0\text{ V}$			0.1	mA	
					0.1	mA	
$I_{GES}$	gate emitter leakage current	$V_{GE} = \pm 20\text{ V}$			500	nA	
$Q_{G(on)}$	total gate charge	$V_{CE} = 600\text{ V}; V_{GE} = 15\text{ V}; I_C = 15\text{ A}$			48	nC	
$t_{d(on)}$	turn-on delay time	inductive load $V_{CE} = 600\text{ V}; I_C = 15\text{ A}$ $V_{GE} = \pm 15\text{ V}; R_G = 56\ \Omega$					
$t_r$	current rise time						
$t_{d(off)}$	turn-off delay time						
$t_f$	current fall time						
$E_{on}$	turn-on energy per pulse						
$E_{off}$	turn-off energy per pulse						
$R_{BSOA}$	reverse bias safe operating area	$V_{GE} = \pm 15\text{ V}; R_G = 56\ \Omega$					
$I_{CM}$		$V_{CEmax} = 1200\text{ V}$			45	A	
$R_{SCSOA}$	short circuit safe operating area	$V_{CEmax} = 1200\text{ V}$					
$t_{sc}$	short circuit duration	$V_{CE} = 900\text{ V}; V_{GE} = \pm 15\text{ V}$			10	$\mu\text{s}$	
$I_{sc}$	short circuit current	$R_G = 56\ \Omega; \text{non-repetitive}$			60	A	
$R_{thJC}$	thermal resistance junction to case				1	K/W	
$R_{thCH}$	thermal resistance case to heatsink				0.30	K/W	
<b>Boost Diode BD</b>							
$V_{RRM}$	max. repetitive reverse voltage	$T_{VJ} = 25^{\circ}\text{C}$			1200	V	
$I_{F25}$	forward current	$T_C = 25^{\circ}\text{C}$			27	A	
$I_{F80}$		$T_C = 80^{\circ}\text{C}$			18	A	
$V_F$	forward voltage	$I_F = 20\text{ A}$			2.20	V	
					1.90	V	
$I_R$	reverse current	$V_R = V_{RRM}$			0.03	mA	
					0.12	mA	
$Q_{rr}$	reverse recovery charge	$V_R = 600\text{ V}$ $-di_F/dt = 400\text{ A}/\mu\text{s}$ $I_F = 20\text{ A}; V_{GE} = 0\text{ V}$					
$I_{RM}$	max. reverse recovery current						
$t_{rr}$	reverse recovery time						
$E_{rec}$	reverse recovery energy						
$R_{thJC}$	thermal resistance junction to case				1.35	K/W	
$R_{thCH}$	thermal resistance case to heatsink				0.4	K/W	

tentative

Package SMPD		Ratings				
Symbol	Definition	Conditions	min.	typ.	max.	Unit
$I_{RMS}$	RMS current	per terminal			100	A
$T_{stg}$	storage temperature		-55		150	°C
$T_{vj}$	virtual junction temperature		-55		150	°C
<b>Weight</b>				8.5		g
$F_C$	mounting force with clip		40		130	N
$V_{ISOL}$	isolation voltage	t = 1 second	3000			V
		t = 1 minute	2500			V
$d_{Spp/App}$	creepage distance on surface   striking distance through air	terminal to terminal	1.6			mm
		terminal to backside	4.0			mm



### Part number

- I = IGBT
- X = XPT IGBT
- A = Gen 1 / std
- 20 = Current Rating [A]
- RG = boost configuration
- 1200 = Reverse Voltage [V]
- D = IGBT
- H = XPT IGBT
- G = Gen 1 / std
- LB = SMPD-B

Ordering	Part Number	Marking on Product	Delivery Mode	Quantity	Code No.
Standard	IXA20RG1200DHGLB	IXA20RG1200DHGLB	Blister	45	512349
Alternative	IXA20RG1200DHGLB-TRR	IXA20RG1200DHGLB	Tape & Reel	200	512370

Similar Part	Package	Voltage class
IXA30RG1200DHGLB	SMPD-B	1200
IXA40RG1200DHGLB	SMPD-B	1200

## Outlines SMPD

A ( 8 : 1 )

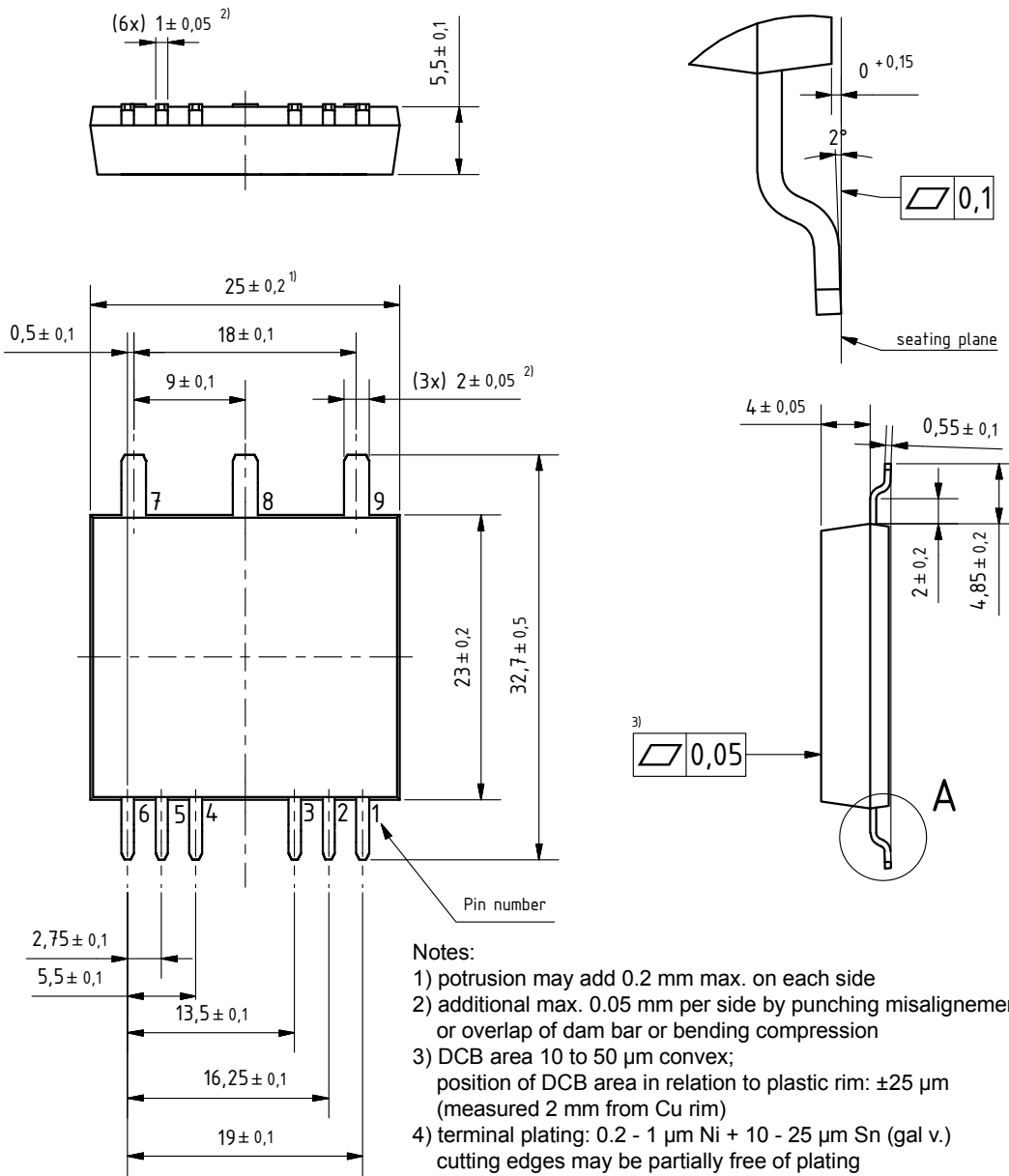

## Boost IGBT

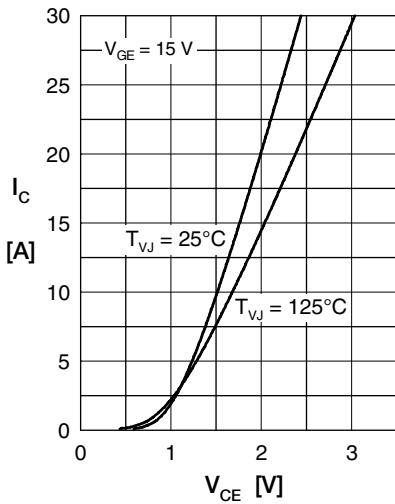

Fig. 1 Typ. output characteristics

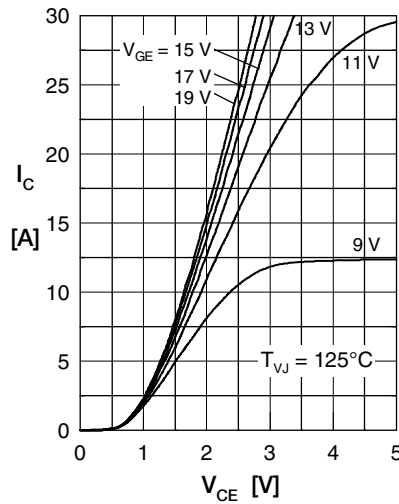

Fig. 2 Typ. output characteristics



Fig. 3 Typ. transfer characteristics



Fig. 4 Typ. turn-on gate charge

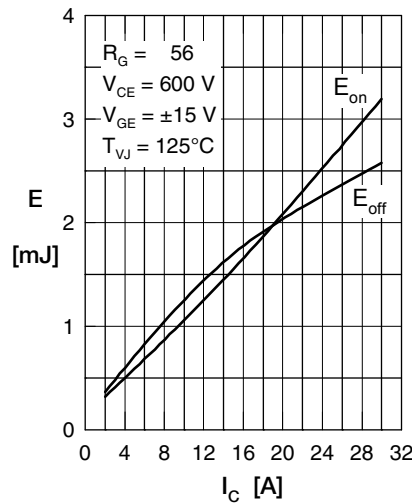

Fig. 5 Typ. switching energy versus collector current

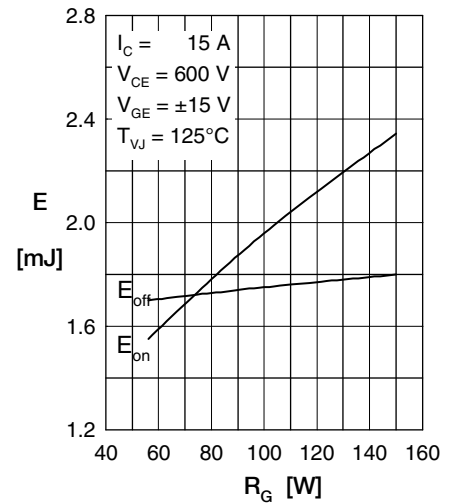

Fig. 6 Typ. switching energy versus gate resistance



Fig. 7 Typ. transient thermal impedance junction to case

## Boost Diode BD

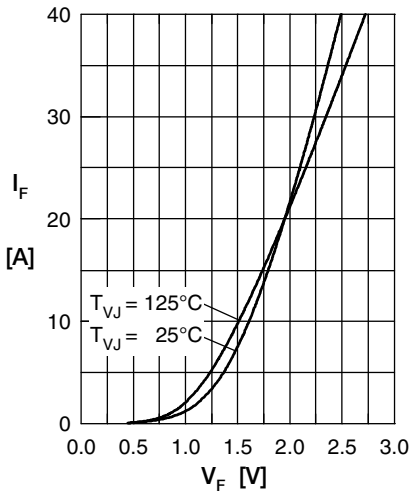

Fig. 1 Typ. Forward current versus  $V_F$

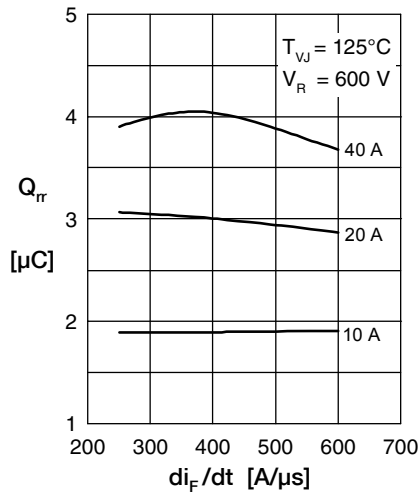

Fig. 2 Typ. reverse recov. charge  $Q_{rr}$  versus  $di_F/dt$

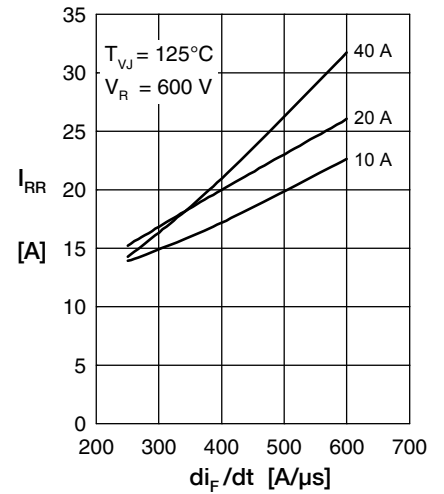

Fig. 3 Typ. peak reverse current  $I_{RRM}$  versus  $di_F/dt$

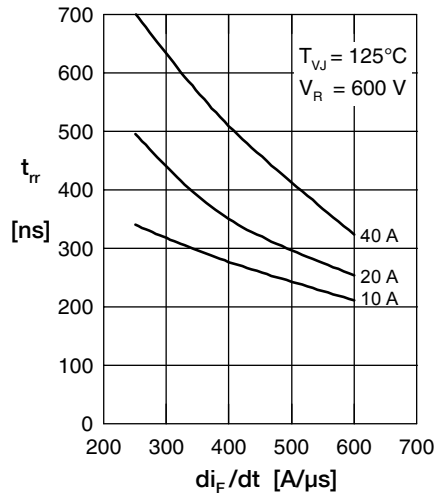

Fig. 4 Dynamic parameters  $Q_{rr}$ ,  $I_{RRM}$  versus  $di/dt$

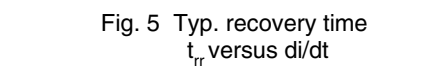

Fig. 5 Typ. recovery time  $t_{rr}$  versus  $di/dt$

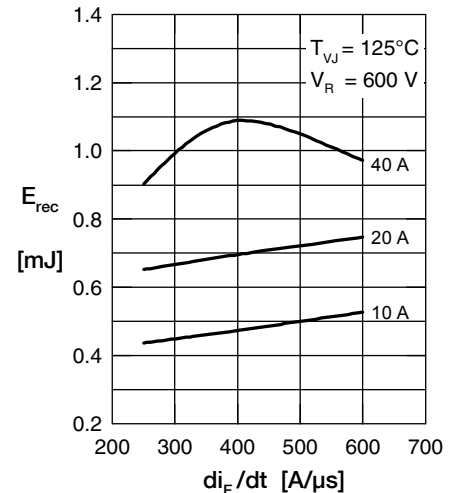

Fig. 6 Typ. recovery energy  $E_{rec}$  versus  $di/dt$

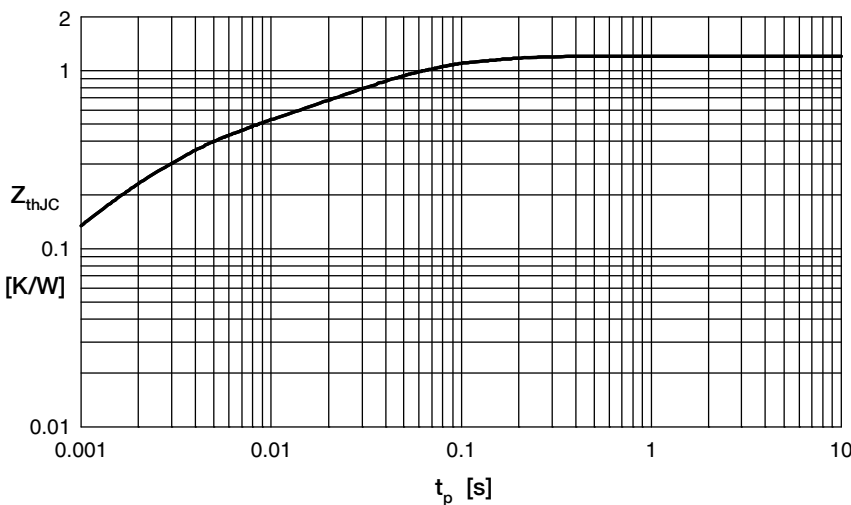

Fig. 7 Typ. transient thermal impedance junction to case



---

Disclaimer Notice - Information furnished is believed to be accurate and reliable. However, users should independently evaluate the suitability of and test each product selected for their own applications. Littelfuse products are not designed for, and may not be used in, all applications. Read complete Disclaimer Notice at [www.littelfuse.com/disclaimer-electronics](http://www.littelfuse.com/disclaimer-electronics).