

# HiPerFAST™ High Speed IGBT C2-Class w/ Diode

**IXGK50N60C2D1**  
**IXGX50N60C2D1**

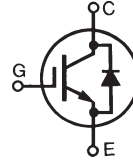

$V_{CES} = 600V$   
 $I_{C110} = 50A$   
 $V_{CE(sat)} \leq 2.7V$   
 $t_{fi(typ)} = 48ns$

Symbol	Test Conditions	Maximum Ratings	
$V_{CES}$	$T_J = 25^\circ C$ to $150^\circ C$	600	V
$V_{CGR}$	$T_J = 25^\circ C$ to $150^\circ C$ , $R_{GE} = 1M\Omega$	600	V
$V_{GES}$	Continuous	$\pm 20$	V
$V_{GEM}$	Transient	$\pm 30$	V
$I_{C25}$	$T_C = 25^\circ C$ (Limited by Leads)	75	A
$I_{C110}$	$T_C = 110^\circ C$	50	A
$I_{F110}$	$T_C = 110^\circ C$	48	A
$I_{CM}$	$T_C = 25^\circ C$ , 1ms	300	A
<b>SSOA</b> <b>(RBSOA)</b>	$V_{GE} = 15V$ , $T_{VJ} = 125^\circ C$ , $R_G = 10\Omega$ Clamped Inductive Load	$I_{CM} = 100$ $V_{CE} \leq V_{CES}$	A
$P_C$	$T_C = 25^\circ C$	480	W
$T_J$		-55 ... +150	$^\circ C$
$T_{JM}$		150	$^\circ C$
$T_{stg}$		-55 ... +150	$^\circ C$
$M_d$	Mounting Torque (TO-264)	1.13 / 10	Nm/lb.in
$F_C$	Mounting Force (PLUS247)	20..120 / 4.5..27	N/lb
$T_L$	Maximum Lead Temperature for Soldering	300	$^\circ C$
$T_{SOLD}$	1.6mm (0.062 in.) from Case for 10s	260	$^\circ C$
<b>Weight</b>	TO-264	10	g
	PLUS247	6	g

TO-264 (IXGK)

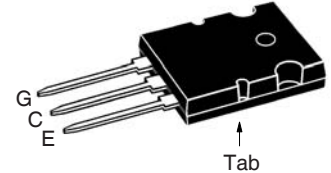

PLUS247 (IXGX)

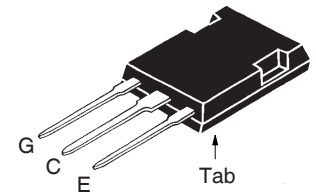

G = Gate                      E = Emitter  
C = Collector                Tab = Collector

## Features

- Very High Frequency IGBT
- Square RBSOA
- Anti-Parallel Ultra Fast Diode
- High Current Handling Capability

## Advantages

- High Power Density
- Low Gate Drive Requirement

## Applications

- Switch-Mode and Resonant-Mode Power Supplies
- Uninterruptible Power Supplies (UPS)
- PFC Circuits
- AC Motor Drives
- DC Servo & Robot Drives
- DC Choppers

Symbol	Test Conditions ( $T_J = 25^\circ C$ , Unless Otherwise Specified)	Characteristic Values		
		Min.	Typ.	Max.
$V_{GE(th)}$	$I_C = 250\mu A$ , $V_{CE} = V_{GE}$	3.0		5.5 V
$I_{CES}$	$V_{CE} = V_{CES}$ , $V_{GE} = 0V$ $T_J = 125^\circ C$			650 $\mu A$ 5 mA
$I_{GES}$	$V_{CE} = 0V$ , $V_{GE} = \pm 20V$			$\pm 100$ nA
$V_{CE(sat)}$	$I_C = 40A$ , $V_{GE} = 15V$ , Note 1 $T_J = 125^\circ C$		1.8	2.7 V V

### Symbol Test Conditions

( $T_J = 25^\circ\text{C}$  Unless Otherwise Specified)

### Characteristic Values

Symbol	Test Conditions	Characteristic Values		
		Min.	Typ.	Max.
$g_{fs}$	$I_C = 40\text{A}, V_{CE} = 10\text{V}, \text{Note 1}$	40	51	S
$C_{ies}$	$V_{CE} = 25\text{V}, V_{GE} = 0\text{V}, f = 1\text{MHz}$		3700	pF
$C_{oes}$			290	pF
$C_{res}$			50	pF
$Q_{g(on)}$	$I_C = 40\text{A}, V_{GE} = 15\text{V}, V_{CE} = 0.5 \cdot V_{CES}$		138	nC
$Q_{ge}$			25	nC
$Q_{gc}$			40	nC
$t_{d(on)}$	<b>Inductive load, <math>T_J = 25^\circ\text{C}</math></b> $I_C = 40\text{A}, V_{GE} = 15\text{V}$		18	ns
$t_{ri}$			25	ns
$t_{d(off)}$	$V_{CE} = 0.8 \cdot V_{CES}, R_G = 2\Omega$		115	150 ns
$t_{fi}$			48	ns
$E_{off}$	Note 2		0.38	0.70 mJ
$t_{d(on)}$	<b>Inductive load, <math>T_J = 125^\circ\text{C}</math></b> $I_C = 40\text{A}, V_{GE} = 15\text{V}$		18	ns
$t_{ri}$			25	ns
$E_{on}$	$V_{CE} = 0.8 \cdot V_{CES}, R_G = 2\Omega$		1.4	mJ
$t_{d(off)}$			170	ns
$t_{fi}$	Note 2		60	ns
$E_{off}$			0.74	mJ
$R_{thJC}$				0.31 $^\circ\text{C/W}$
$R_{thCS}$		0.15		$^\circ\text{C/W}$

### Reverse Diode (FRED)

### Symbol Test Conditions

( $T_J = 25^\circ\text{C}$  Unless Otherwise Specified)

### Characteristic Values

Symbol	Test Conditions	Characteristic Values		
		Min.	Typ.	Max.
$V_F$	$I_F = 60\text{A}, V_{GE} = 0\text{V}, \text{Note 1}$			2.1 V
			$T_J = 150^\circ\text{C}$	1.4 V
$I_{RM}$	$I_F = 60\text{A}, V_{GE} = 0\text{V}, -di_F/dt = 100\text{A}/\mu\text{s}, T_J = 100^\circ\text{C}$ $V_R = 100\text{V}$			8.3 A
$t_{rr}$	$I_F = 1\text{A}, -di/dt = 200\text{A}/\mu\text{s}, V_R = 30\text{V}$		35	ns
$R_{thJC}$				0.65 $^\circ\text{C/W}$

### Notes:

1. Pulse test,  $t \leq 300\mu\text{s}$ , duty cycle,  $d \leq 2\%$ .
2. Switching times & energy losses may increase for higher  $V_{CE}(\text{clamp})$ ,  $T_J$  or  $R_G$ .

### TO-264 Outline

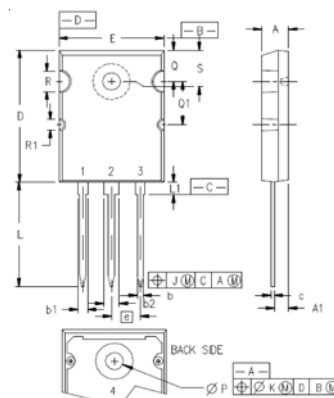

Terminals: 1 = Gate  
2,4 = Collector  
3 = Emitter

SYM	INCHES		MILLIMETERS	
	MIN	MAX	MIN	MAX
A	.185	.209	4.70	5.31
A1	.102	.118	2.59	3.00
b	.037	.055	0.94	1.40
b1	.087	.102	2.21	2.59
b2	.110	.126	2.79	3.20
c	.017	.029	0.43	0.74
D	1.007	1.047	25.58	26.59
E	.760	.799	19.30	20.29
e	.215 BSC		5.46 BSC	
J	.000	.010	0.00	0.25
K	.000	.010	0.00	0.25
L	.779	.842	19.79	21.39
L1	.087	.102	2.21	2.59
ØP	.122	.138	3.10	3.51
Q	.240	.256	6.10	6.50
Q1	.330	.346	8.38	8.79
ØR	.155	.187	3.94	4.75
ØR1	.085	.093	2.16	2.36
S	.243	.253	6.17	6.43

### PLUS247™ Outline

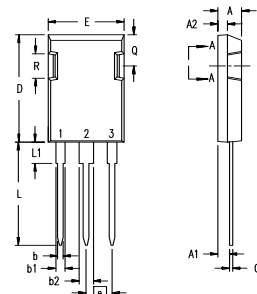

Terminals: 1 - Gate  
2 - Collector  
3 - Emitter

Dim.	Millimeter		Inches	
	Min.	Max.	Min.	Max.
A	4.83	5.21	.190	.205
A <sub>1</sub>	2.29	2.54	.090	.100
A <sub>2</sub>	1.91	2.16	.075	.085
b	1.14	1.40	.045	.055
b <sub>1</sub>	1.91	2.13	.075	.084
b <sub>2</sub>	2.92	3.12	.115	.123
C	0.61	0.80	.024	.031
D	20.80	21.34	.819	.840
E	15.75	16.13	.620	.635
e	5.45 BSC		.215 BSC	
L	19.81	20.32	.780	.800
L1	3.81	4.32	.150	.170
Q	5.59	6.20	.220	0.244
R	4.32	4.83	.170	.190

IXYS Reserves the Right to Change Limits, Test conditions, and Dimensions.

IXYS MOSFETs and IGBTs are covered by one or more of the following U.S. patents:	4,835,592	4,931,844	5,049,961	5,237,481	6,162,665	6,404,065 B1	6,683,344	6,727,585	7,005,734 B2	7,157,338 B2
	4,860,072	5,017,508	5,063,307	5,381,025	6,259,123 B1	6,534,343	6,710,405 B2	6,759,692	7,063,975 B2	
	4,881,106	5,034,796	5,187,117	5,486,715	6,306,728 B1	6,583,505	6,710,463	6,771,478 B2	7,071,537	

**Fig. 1. Output Characteristics**  
@  $T_J = 25^\circ\text{C}$

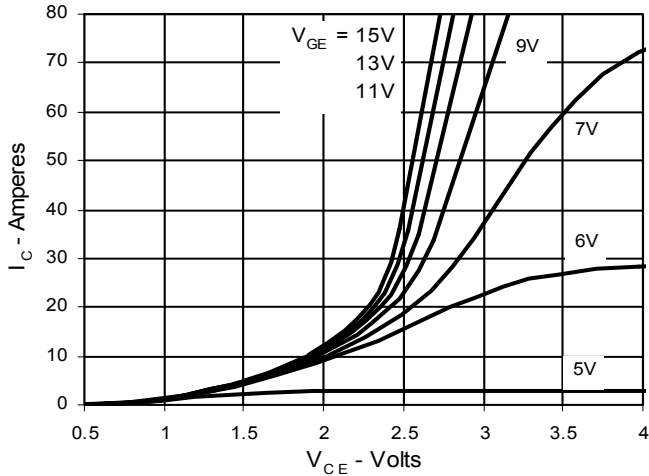

**Fig. 2. Extended Output Characteristics**  
@  $T_J = 25^\circ\text{C}$

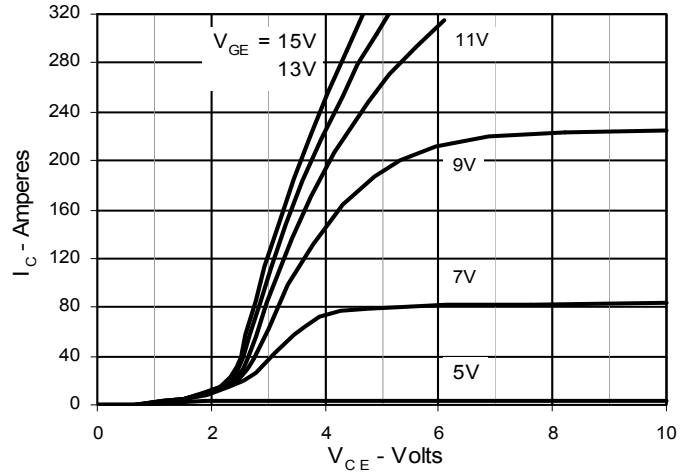

**Fig. 3. Output Characteristics**  
@  $T_J = 125^\circ\text{C}$

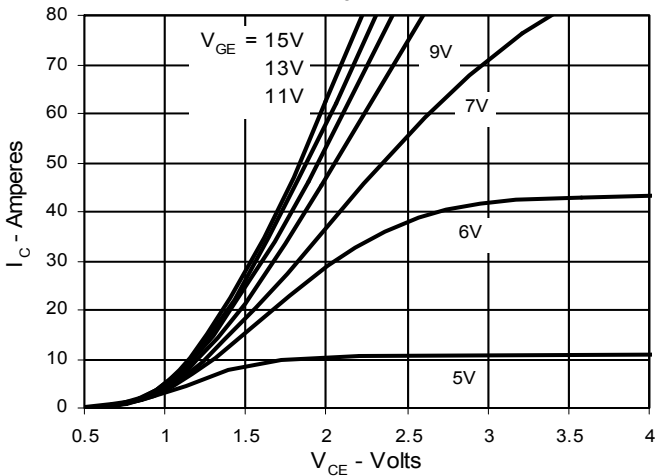

**Fig. 4. Dependence of  $V_{CE(sat)}$  on Temperature**

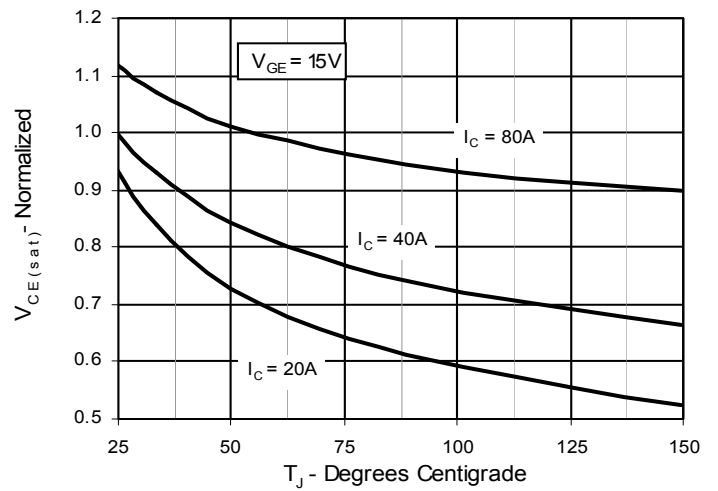

**Fig. 5. Collector-to-Emitter Voltage vs. Gate-to-Emitter voltage**

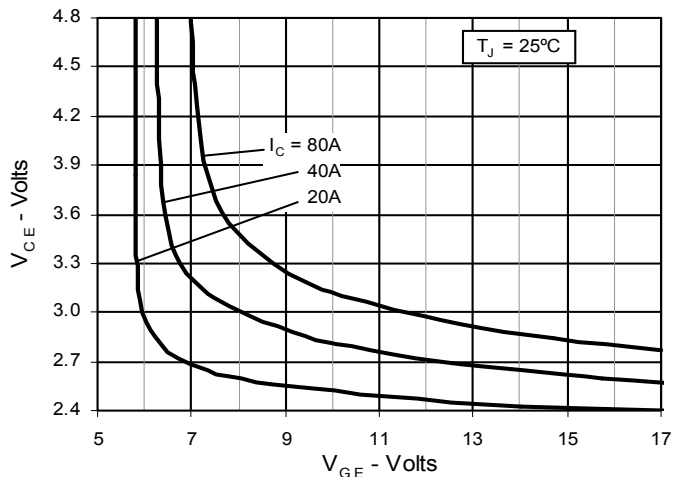

**Fig. 6. Input Admittance**

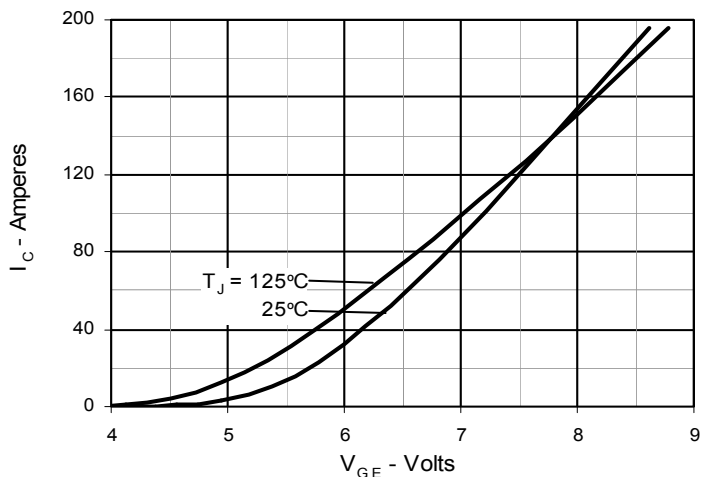

Fig. 7. Transconductance

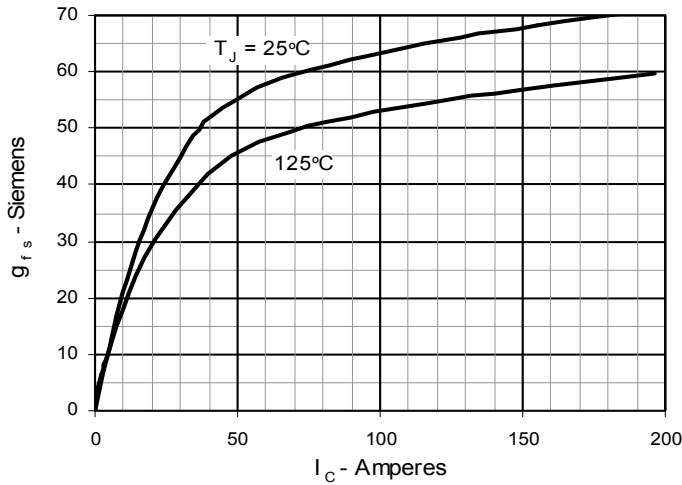

Fig. 8. Dependence of Turn-Off Energy on  $R_G$

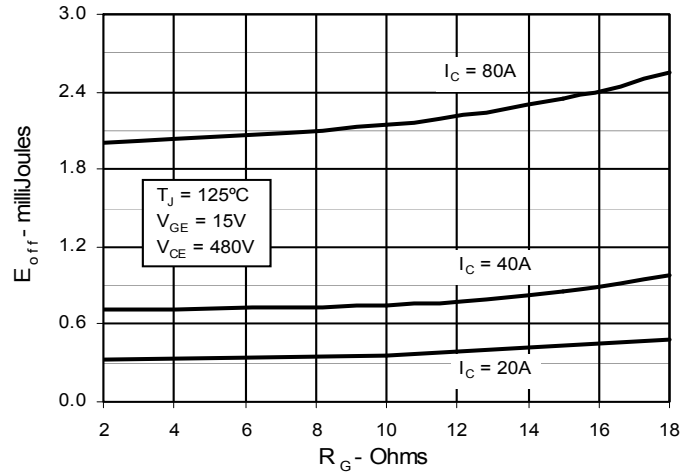

Fig. 9. Dependence of Turn-Off Energy on  $I_C$

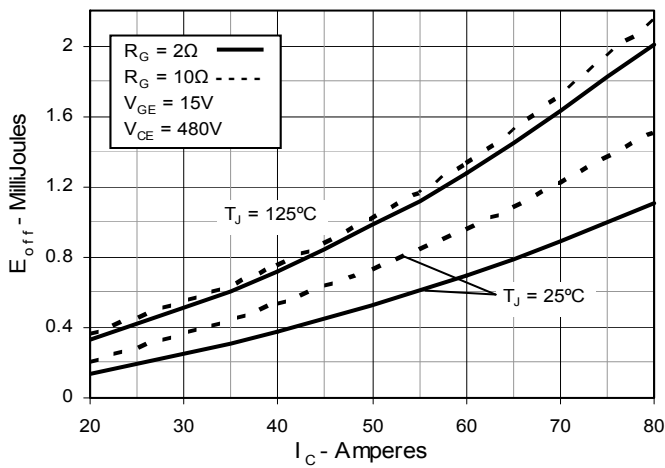

Fig. 10. Dependence of Turn-Off Energy on Temperature

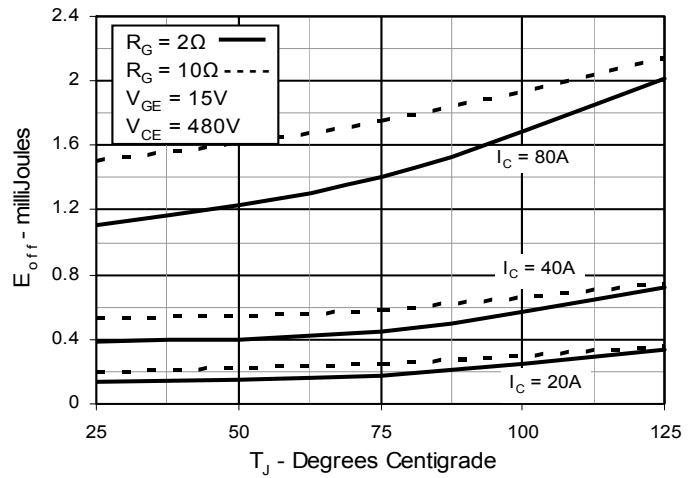

Fig. 11. Dependence of Turn-Off Switching Time on  $R_G$

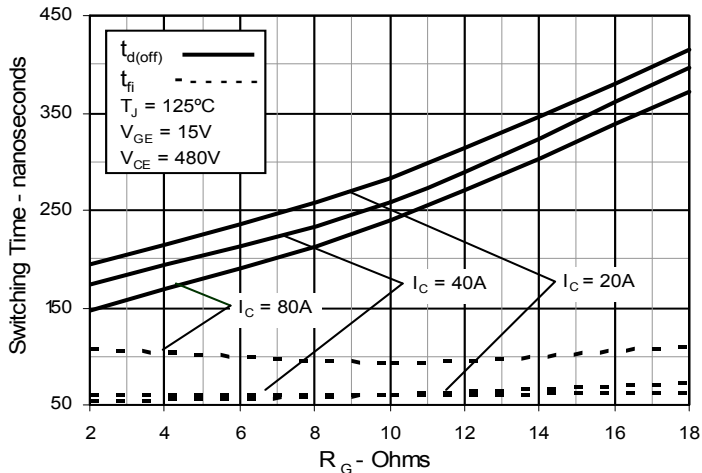
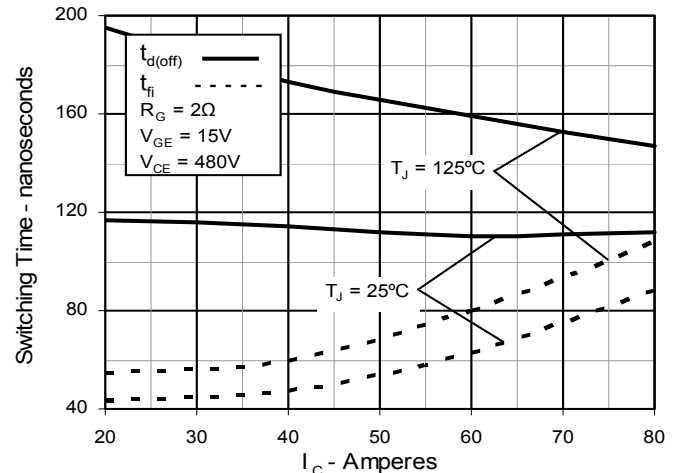
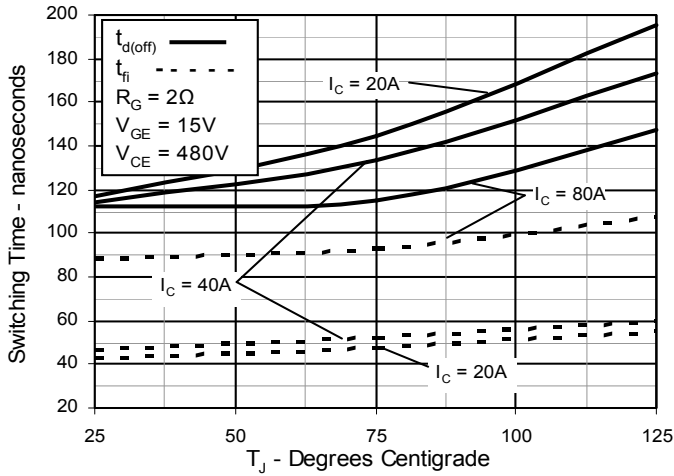

Fig. 12. Dependence of Turn-Off Switching Time on  $I_C$



**Fig. 13. Dependence of Turn-Off Switching Time on Temperature**



**Fig. 14. Reverse-Bias Safe Operating Area**

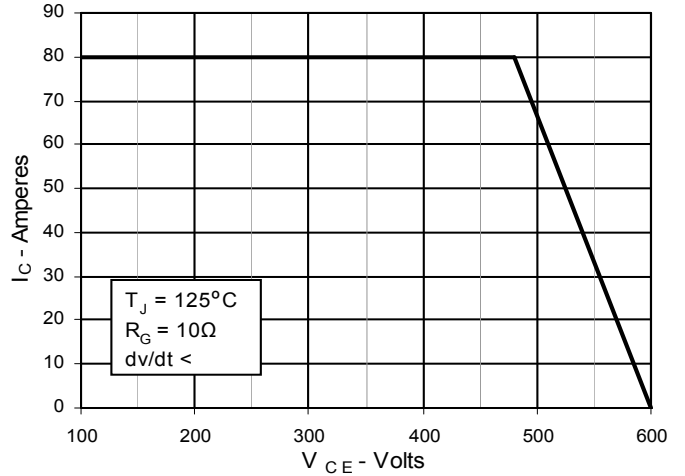

**Fig. 15. Gate Charge**

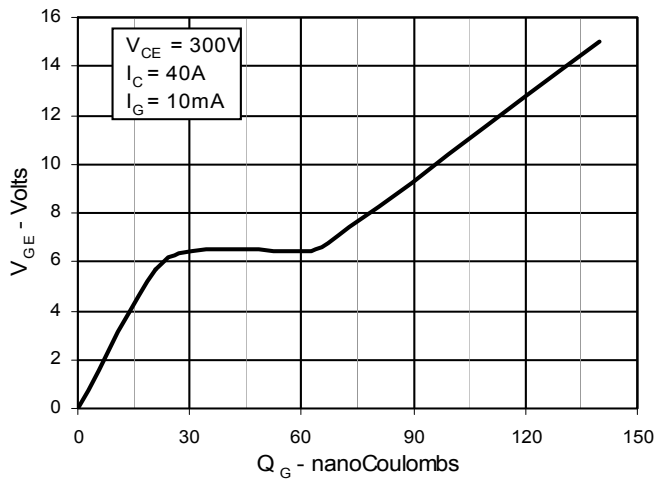

**Fig. 16. Capacitance**

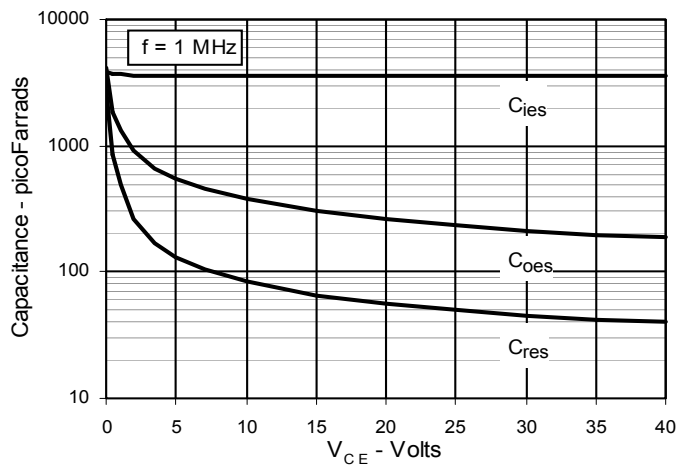

**Fig. 17. Maximum Transient Thermal Resistance**

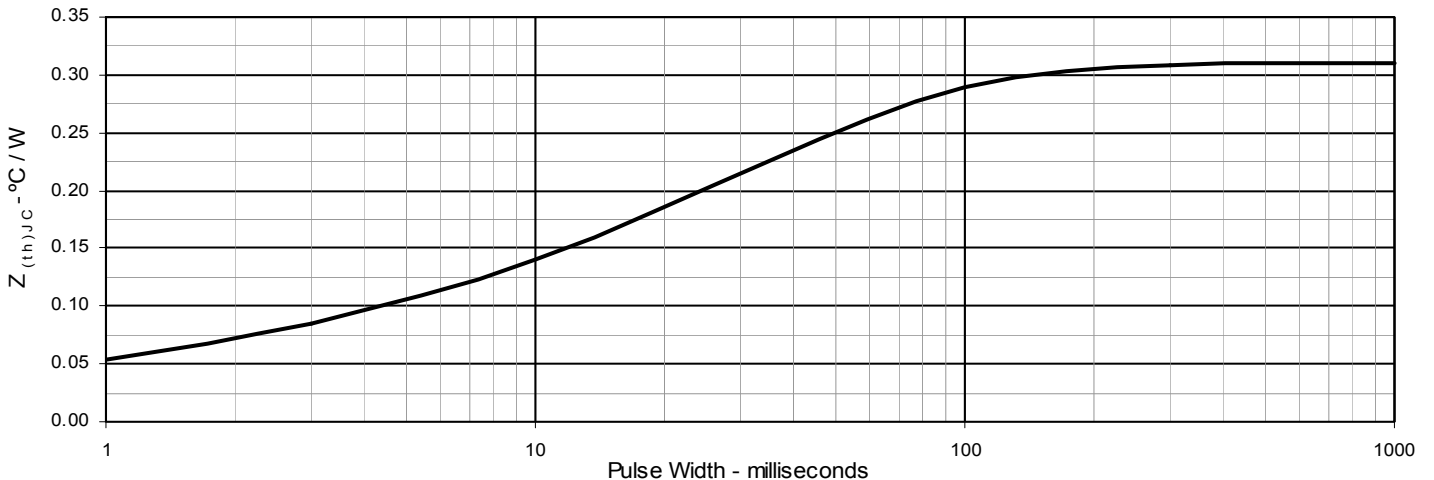

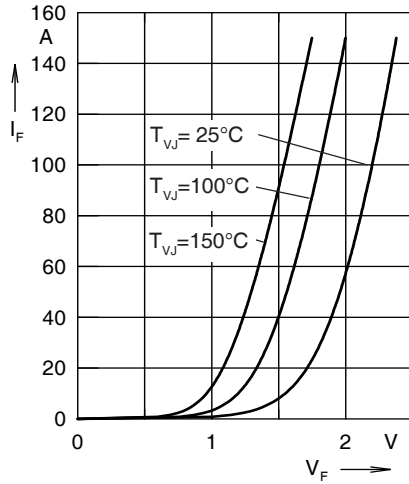

Fig. 18. Forward current  $I_F$  versus  $V_F$

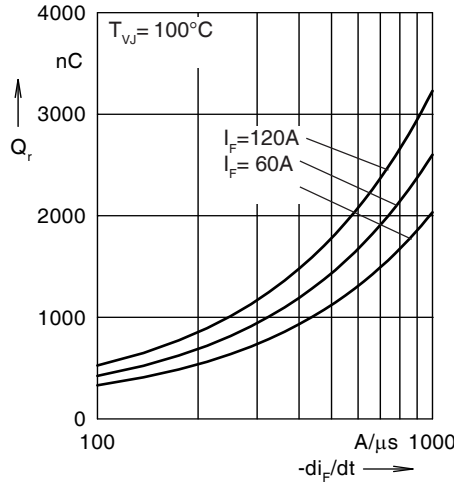

Fig. 19. Reverse recovery charge  $Q_r$

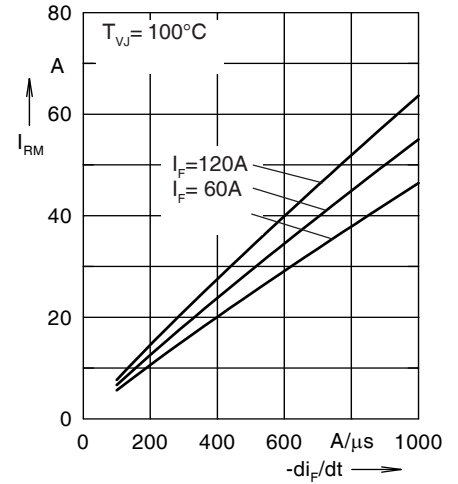

Fig. 20. Peak reverse current  $I_{RM}$

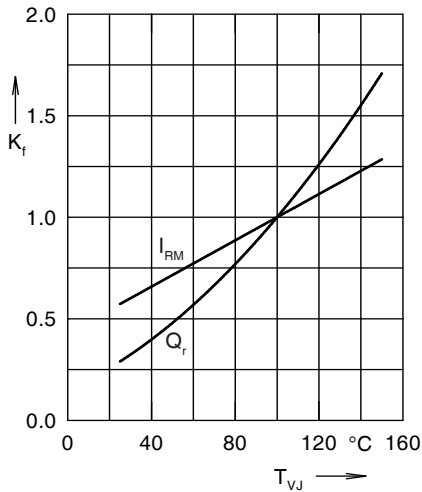

Fig. 21. Dynamic parameters  $Q_r$ ,  $I_{RM}$

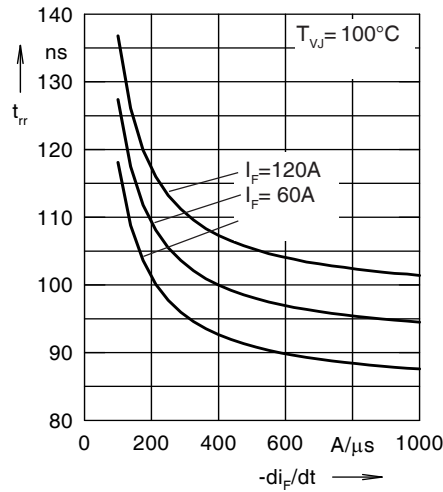

Fig. 22. Recovery time  $t_{rr}$  versus  $-di_F/dt$

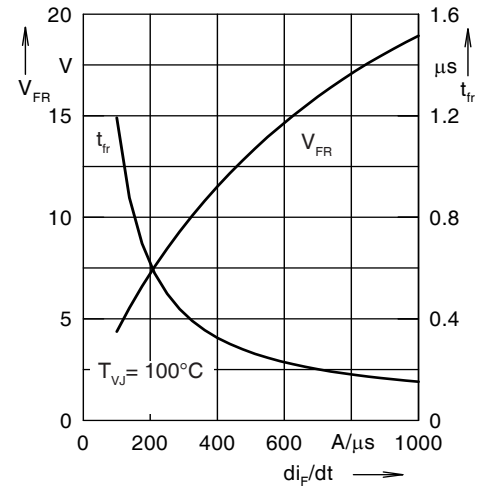

Fig. 23. Peak forward voltage  $V_{FR}$  and  $t_{rr}$

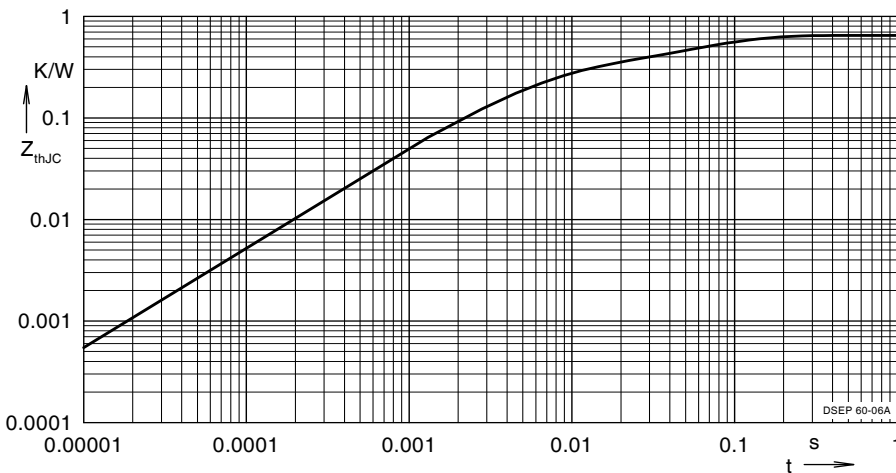

Fig. 24. Transient thermal resistance junction to case

Constants for  $Z_{thJC}$  calculation:

i	$R_{thi}$ (K/W)	$t_i$ (s)
1	0.324	0.0052
2	0.125	0.0003

Note: Fig. 2 through Fig. 6 show typical



---

Disclaimer Notice - Information furnished is believed to be accurate and reliable. However, users should independently evaluate the suitability of and test each product selected for their own applications. Littelfuse products are not designed for, and may not be used in, all applications. Read complete Disclaimer Notice at [www.littelfuse.com/disclaimer-electronics](http://www.littelfuse.com/disclaimer-electronics).