

High Voltage IGBT w/ Diode

IXGH28N120BD1 IXGT28N120BD1

$V_{CES} = 1200V$
 $I_{C25} = 50A$
 $V_{CE(sat)} \leq 3.5V$
 $t_{fi(typ)} = 170ns$

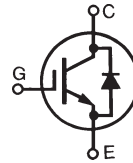

Symbol	Test Conditions	Maximum Ratings	
V_{CES}	$T_J = 25^\circ C$ to $150^\circ C$	1200	V
V_{CGR}	$T_J = 25^\circ C$ to $150^\circ C$, $R_{GE} = 1M\Omega$	1200	V
V_{GES}	Continuous	± 20	V
V_{GEM}	Transient	± 30	V
I_{C25}	$T_C = 25^\circ C$ (Chip Capability)	50	A
I_{C100}	$T_C = 100^\circ C$	28	A
I_{F90}	$T_C = 90^\circ C$	10	A
I_{CM}	$T_C = 25^\circ C$, 1ms	150	A
SSOA	$V_{GE} = 15V$, $T_J = 125^\circ C$, $R_G = 5\Omega$	$I_{CM} = 120$	A
(RBSOA)	Clamped Inductive Load	$0.8 \cdot V_{CES}$	
P_C	$T_C = 25^\circ C$	250	W
T_J		-55 ... +150	$^\circ C$
T_{JM}		150	$^\circ C$
T_{stg}		-55 ... +150	$^\circ C$
T_L	Maximum Lead Temperature for Soldering	300	$^\circ C$
T_{SOLD}	1.6 mm (0.062 in.) from Case for 10	260	$^\circ C$
M_d	Mounting Torque (TO-247)	1.13/10	Nm/lb.in.
Weight	TO-247	6	g
	TO-286	4	g

TO-247AD (IXGH)

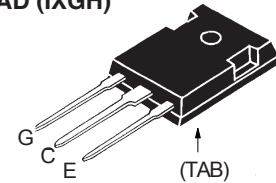

TO-268 (IXGT)

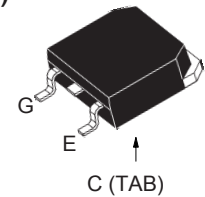

G = Gate C = Collector
 E = Emitter TAB = Collector

Features

- International Standard Packages JEDEC TO-247AD & TO-268
- IGBT and Anti-Parallel FRED for Resonant Power Supplies
 - Induction Heating
 - Rice Cookers
- MOS Gate Turn-On
- Fast Recovery Exptial Diode (FRED)
 - Soft Recovery with Low I_{RM}

Advantages

- Saves Space (Two Devices in One Package)
- Easy to Mount with 1 Screw (Isolated Mounting Screw Hole)
- Reduces Assembly Time and Cost

Applications

- Switch-Mode and Resonant-Mode Power Supplies
- Uninterruptible Power Supplies (UPS)
- DC Choppers
- AC Motor Speed Drives
- DC Servo and Robot Drives

Symbol	Test Conditions ($T_J = 25^\circ C$, Unless Otherwise Specified)	Characteristic Values		
		Min.	Typ.	Max.
$V_{GE(th)}$	$I_C = 250\mu A$, $V_{CE} = V_{GE}$	2.5		5.0 V
I_{CES}	$V_{CE} = V_{CES}$, $V_{GE} = 0V$ $T_J = 125^\circ C$, Note1			50 μA 250 μA
I_{GES}	$V_{CE} = 0V$, $V_{GE} = \pm 20V$			± 100 nA
$V_{CE(sat)}$	$I_C = 28A$, $V_{GE} = 15V$, Note 2 $T_J = 125^\circ C$	2.9		3.5 V
		2.8		V

Symbol	Test Conditions ($T_J = 25^\circ\text{C}$, Unless Otherwise Specified)	Characteristic Values		
		Min.	Typ.	Max.
g_{fs}	$I_C = 28\text{A}$, $V_{CE} = 10\text{V}$, Note 2	15	23	S
C_{ies}	$V_{CE} = 25\text{V}$, $V_{GE} = 0\text{V}$, $f = 1\text{MHz}$		1700	pF
C_{oes}			130	pF
C_{res}			45	pF
Q_g	$I_C = 28\text{A}$, $V_{GE} = 15\text{V}$, $V_{CE} = 0.5 \cdot V_{CES}$		92	nC
Q_{ge}			13	nC
Q_{gc}			35	nC
$t_{d(on)}$	Inductive load, $T_J = 25^\circ\text{C}$		30	ns
t_{ri}		$I_C = 28\text{A}$, $V_{GE} = 15\text{V}$	20	ns
$t_{d(off)}$	$V_{CE} = 0.8 \cdot V_{CES}$, $R_G = 5\Omega$ Note 3		210	ns
t_{fi}			170	ns
E_{off}		2.2	5.0	mJ
$t_{d(on)}$	Inductive load, $T_J = 125^\circ\text{C}$		35	ns
t_{ri}		$I_C = 28\text{A}$, $V_{GE} = 15\text{V}$	28	ns
E_{on}	$V_{CE} = 0.8 \cdot V_{CES}$, $R_G = 5\Omega$ Note 3		1.4	mJ
$t_{d(off)}$			250	ns
t_{fi}		340	ns	
E_{off}		4.6	mJ	
R_{thJC}				0.50 $^\circ\text{C/W}$
R_{thCK}	(TO-247)	0.21		$^\circ\text{C/W}$

TO-247 (IXGH) Outline

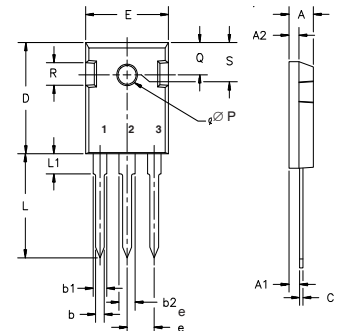

Terminals: 1 - Gate 2 - Drain
3 - Source Tab - Drain

Dim.	Millimeter		Inches	
	Min.	Max.	Min.	Max.
A	4.7	5.3	.185	.209
A ₁	2.2	2.54	.087	.102
A ₂	2.2	2.6	.059	.098
b	1.0	1.4	.040	.055
b ₁	1.65	2.13	.065	.084
b ₂	2.87	3.12	.113	.123
C	.4	.8	.016	.031
D	20.80	21.46	.819	.845
E	15.75	16.26	.610	.640
e	5.20	5.72	0.205	0.225
L	19.81	20.32	.780	.800
L ₁		4.50		.177
∅P	3.55	3.65	.140	.144
Q	5.89	6.40	0.232	0.252
R	4.32	5.49	.170	.216
S	6.15	BSC	242	BSC

Reverse Diode (FRED)

Symbol	Test Conditions ($T_J = 25^\circ\text{C}$, Unless Otherwise Specified)	Characteristic Values		
		Min.	Typ.	Max.
V_F	$I_F = 10\text{A}$, $V_{GE} = 0\text{V}$, Note 2 $T_J = 100^\circ\text{C}$		2.3	3.2 V
I_{RM}	$I_F = 10\text{A}$, $V_{GE} = 0\text{V}$, $-di_F/dt = 400\text{A}/\mu\text{s}$, $V_R = 600\text{V}$		14	A
t_{rr}			120	ns
t_{rr}	$I_F = 1\text{A}$, $V_{GE} = 0\text{V}$, $-di_F/dt = 100\text{A}/\mu\text{s}$, $V_R = 30\text{V}$		40	ns
R_{thJC}				2.5 $^\circ\text{C/W}$

Notes:

- Part must be heatsunk for high-temp I_{CES} measurement.
- Pulse test, $t \leq 300\mu\text{s}$, duty cycle, $d \leq 2\%$.
- Switching times & energy losses may increase for higher V_{CE} (Clamp), T_J or R_G .

TO-268 (IXGT) Outline

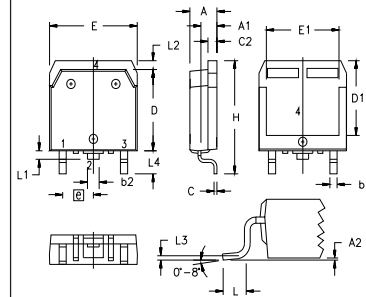

SYM	INCHES		MILLIMETERS	
	MIN	MAX	MIN	MAX
A	.193	.201	4.90	5.10
A ₁	.106	.114	2.70	2.90
A ₂	.001	.010	0.02	0.25
b	.045	.057	1.15	1.45
b ₂	.075	.083	1.90	2.10
C	.016	.026	0.40	0.65
C ₂	.057	.063	1.45	1.60
D	.543	.551	13.80	14.00
D ₁	.488	.500	12.40	12.70
E	.624	.632	15.85	16.05
E ₁	.524	.535	13.30	13.60
e	.215 BSC		5.45 BSC	
H	.736	.752	18.70	19.10
L	.094	.106	2.40	2.70
L ₁	.047	.055	1.20	1.40
L ₂	.039	.045	1.00	1.15
L ₃	.010 BSC		0.25 BSC	
L ₄	.150	.161	3.80	4.10

IXYS reserves the right to change limits, test conditions and dimensions.

IXYS MOSFETs and IGBTs are covered by one or more of the following U.S. patents:	4,835,592	4,931,844	5,049,961	5,237,481	6,162,665	6,404,065 B1	6,683,344	6,727,585	7,005,734 B2	7,157,338B2
	4,850,072	5,017,508	5,063,307	5,381,025	6,259,123 B1	6,534,343	6,710,405 B2	6,759,692	7,063,975 B2	
	4,881,106	5,034,796	5,187,117	5,486,715	6,306,728 B1	6,583,505	6,710,463	6,771,478 B2	7,071,537	

Fig. 1. Output Characteristics @ 25 °C

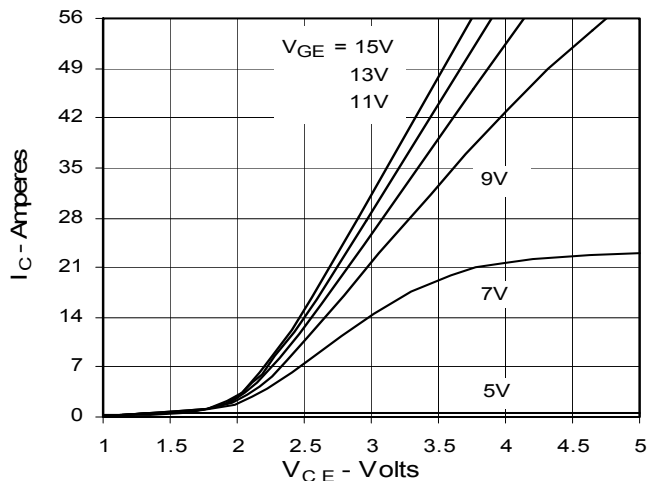

Fig. 2. Extended Output Characteristics @ 25 °C

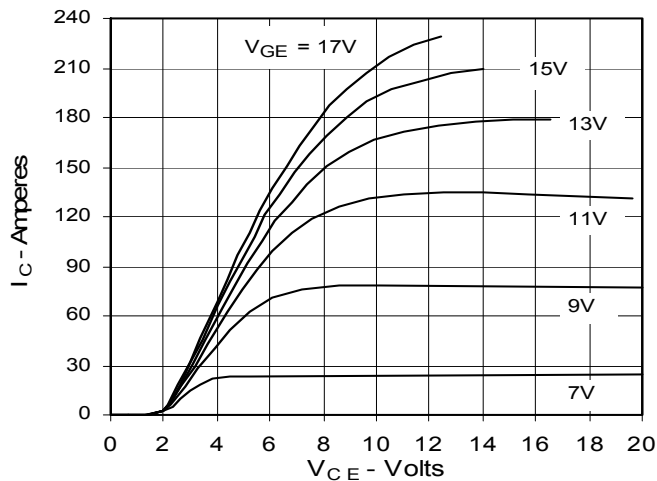

Fig. 3. Output Characteristics @ 125 °C

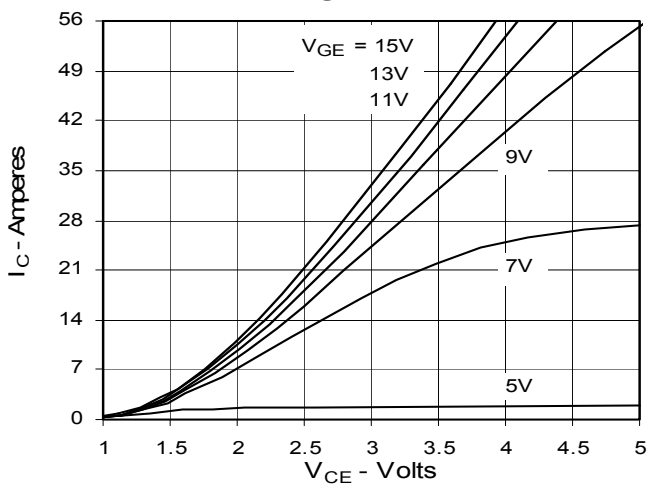

Fig. 4. Dependence of $V_{CE(sat)}$ on Temperature

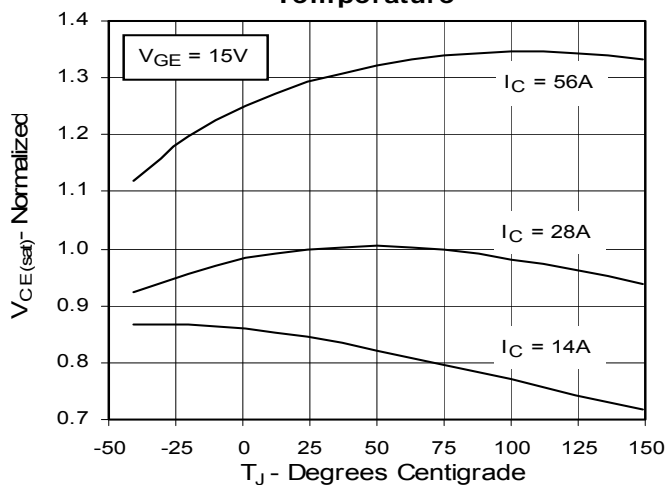

Fig. 5. Collector-to-Emitter Voltage vs. Gate-to-Emitter voltage

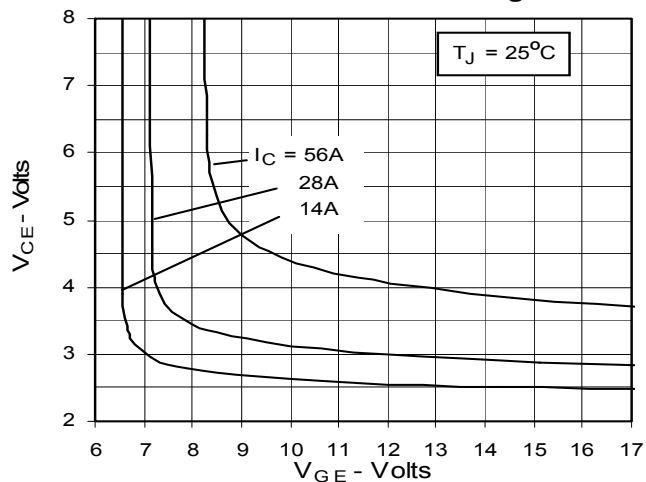

Fig. 6. Input Admittance

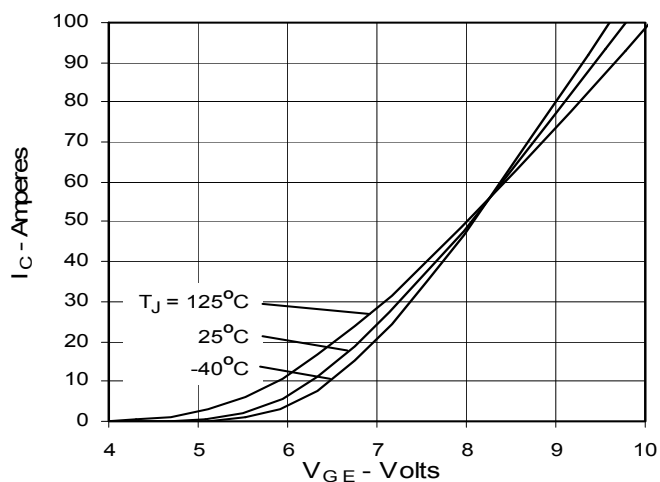

Fig. 7. Transconductance

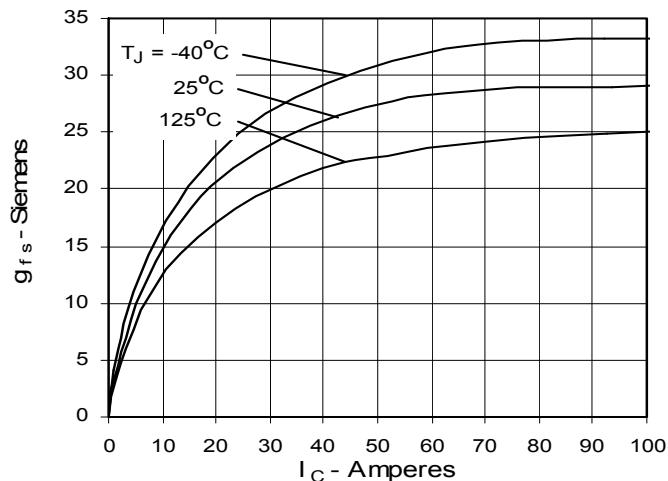

Fig. 8. Dependence of Turn-off Energy Loss on R_G

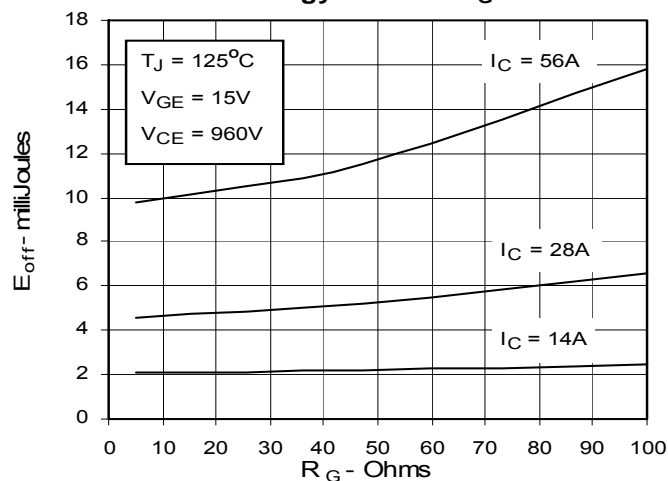

Fig. 9. Dependence of Turn-Off Energy Loss on I_C

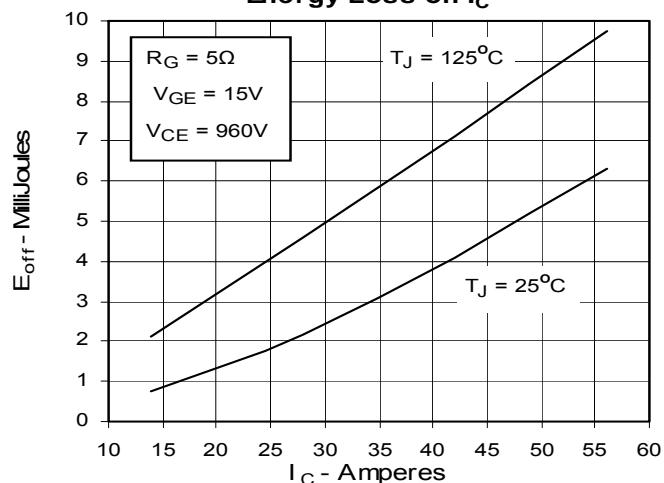

Fig. 10. Dependence of Turn-off Energy Loss on Temperature

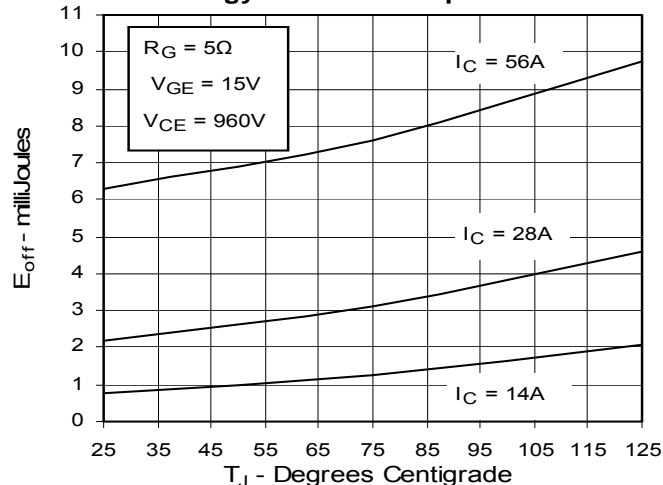

Fig. 11. Dependence of Turn-off Switching Time on R_G

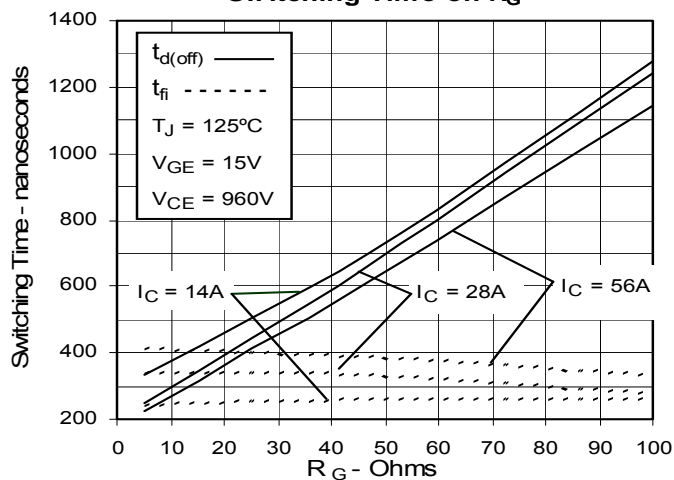

Fig. 12. Dependence of Turn-off Switching Time on I_C

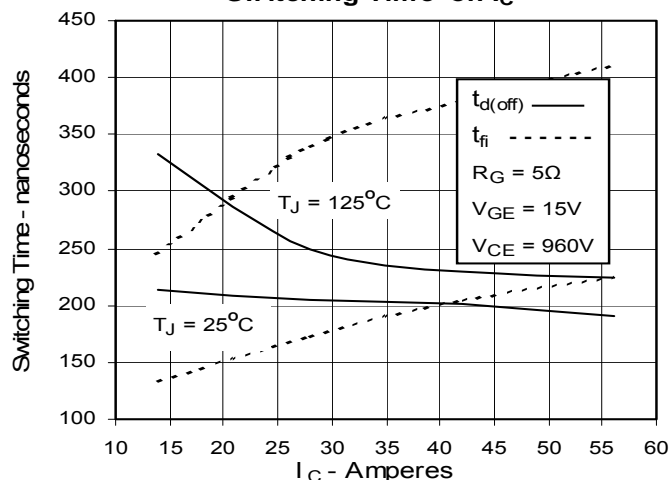

Fig. 13. Dependence of Turn-off Switching Time on Temperature

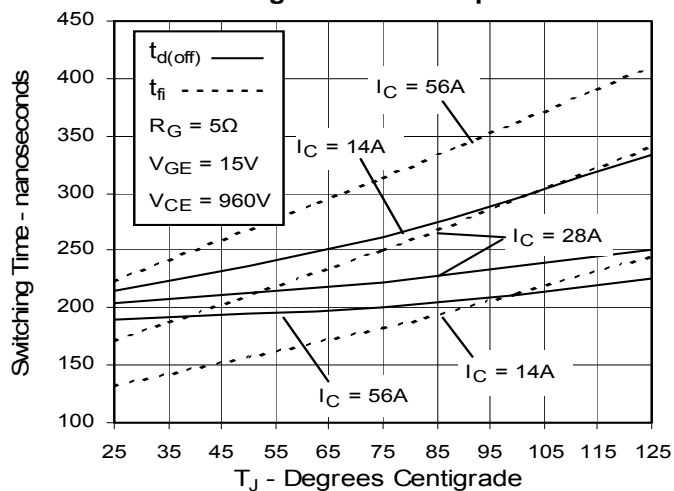

Fig. 14. Gate Charge

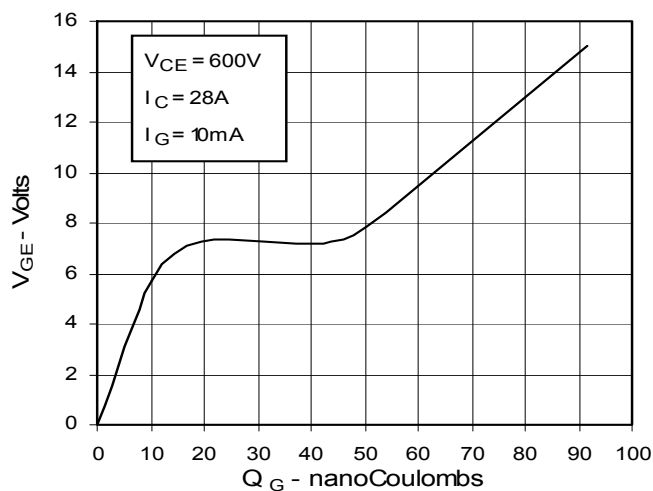

Fig. 15. Capacitance

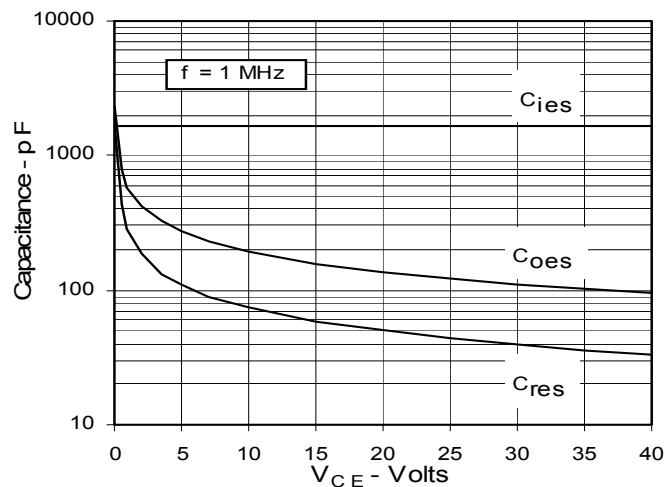

Fig. 16. Reverse-Bias Safe Operating Area

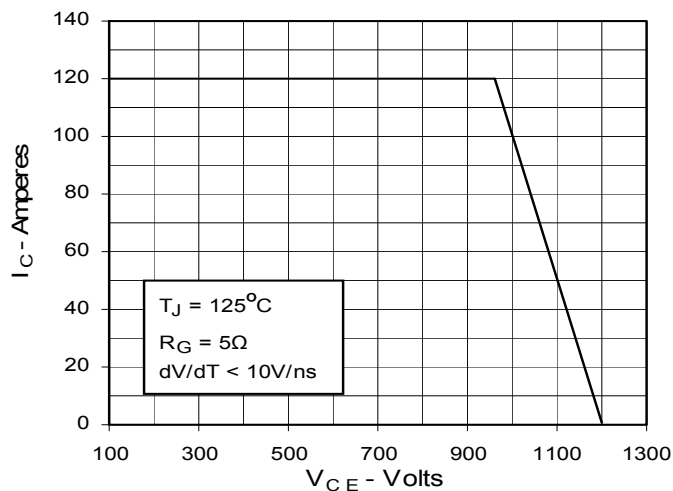
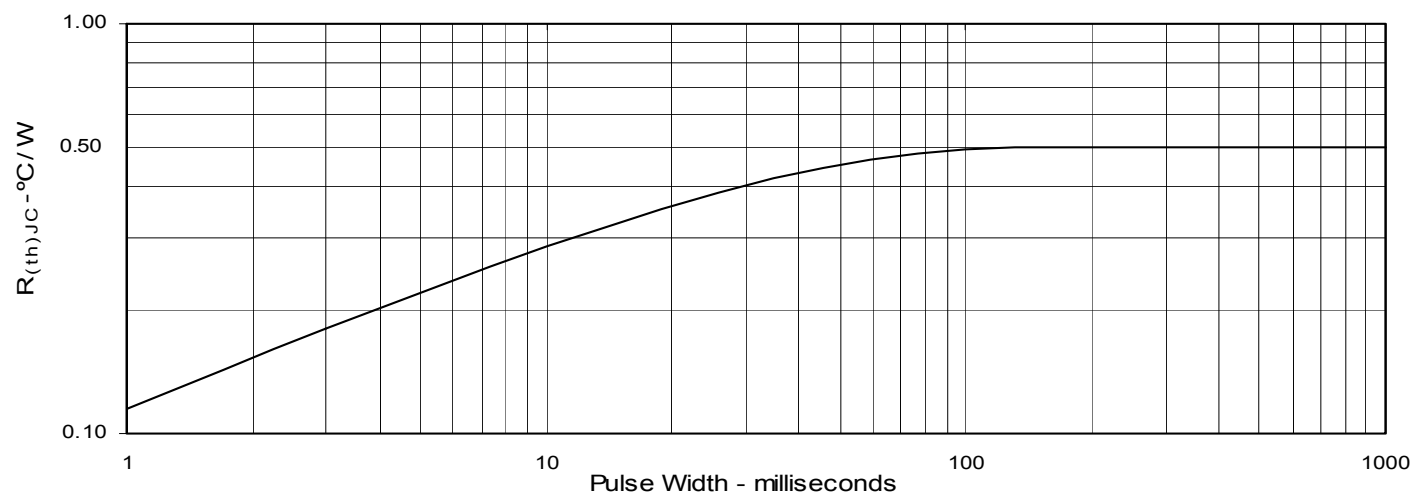

Fig. 17. Maximum Transient Thermal Resistance



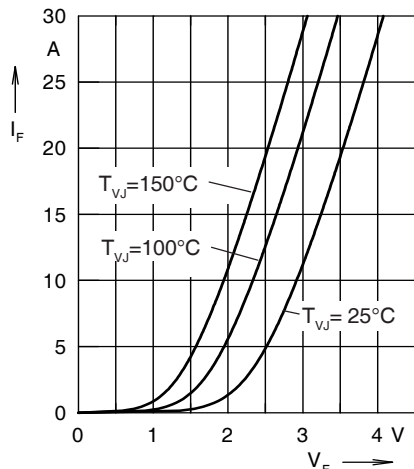

Fig. 18. Forward current I_F versus V_F

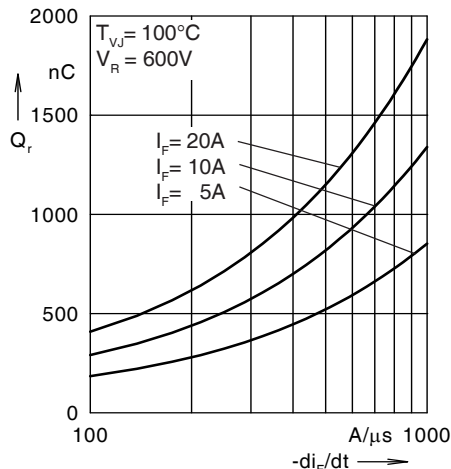

Fig. 19. Reverse recovery charge Q_r versus $-di_F/dt$

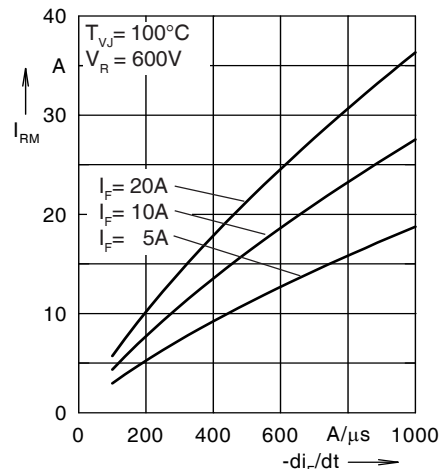

Fig. 20. Peak reverse current I_{RM} versus $-di_F/dt$

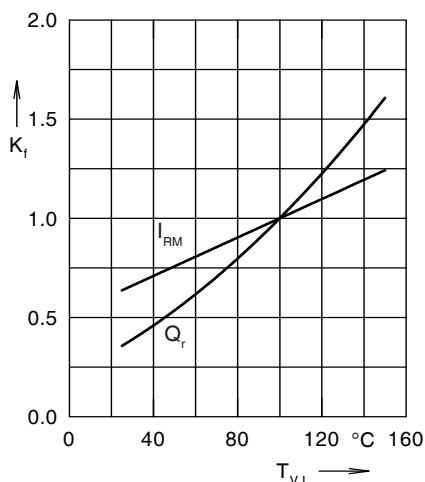

Fig. 21. Dynamic parameters Q_r , I_{RM} versus T_{VJ}

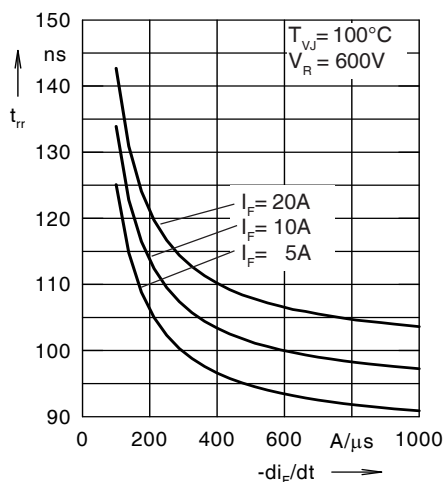

Fig. 22. Recovery time t_{rr} versus $-di_F/dt$

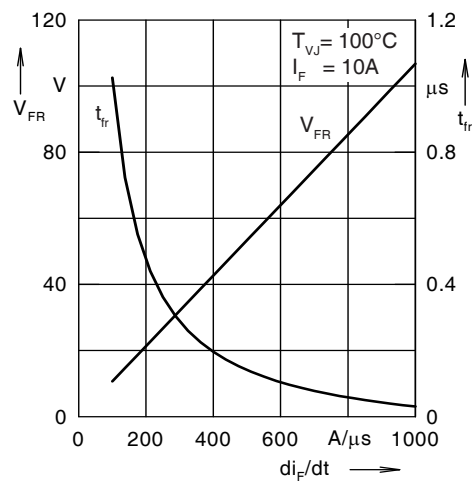

Fig. 23. Peak forward voltage V_{FR} and t_{tr} versus di_F/dt

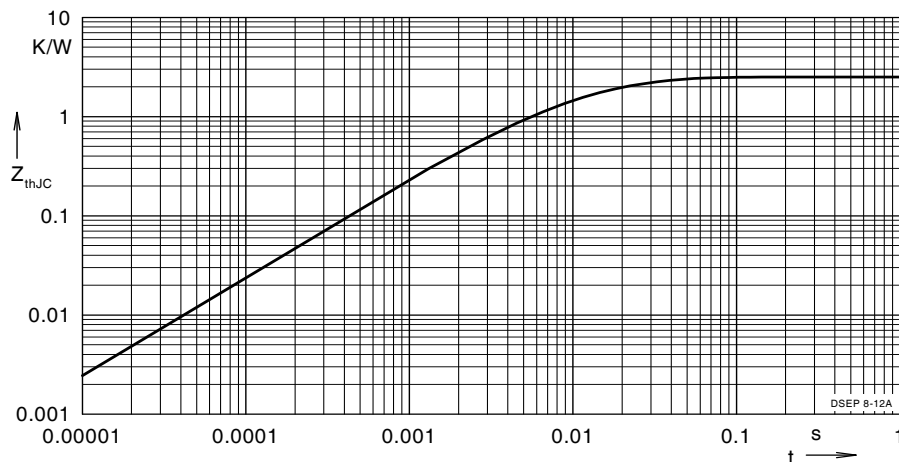

Fig. 24. Transient thermal resistance junction to case

Constants for Z_{thJC} calculation:

i	R_{thi} (K/W)	t_i (s)
1	1.449	0.0052
2	0.558	0.0003
3	0.493	0.017



Disclaimer Notice - Information furnished is believed to be accurate and reliable. However, users should independently evaluate the suitability of and test each product selected for their own applications. Littelfuse products are not designed for, and may not be used in, all applications. Read complete Disclaimer Notice at www.littelfuse.com/disclaimer-electronics.